

# Pilots Manual

## For F4U

## CORSAIR



# Pilots Manual for

## F4U Corsair

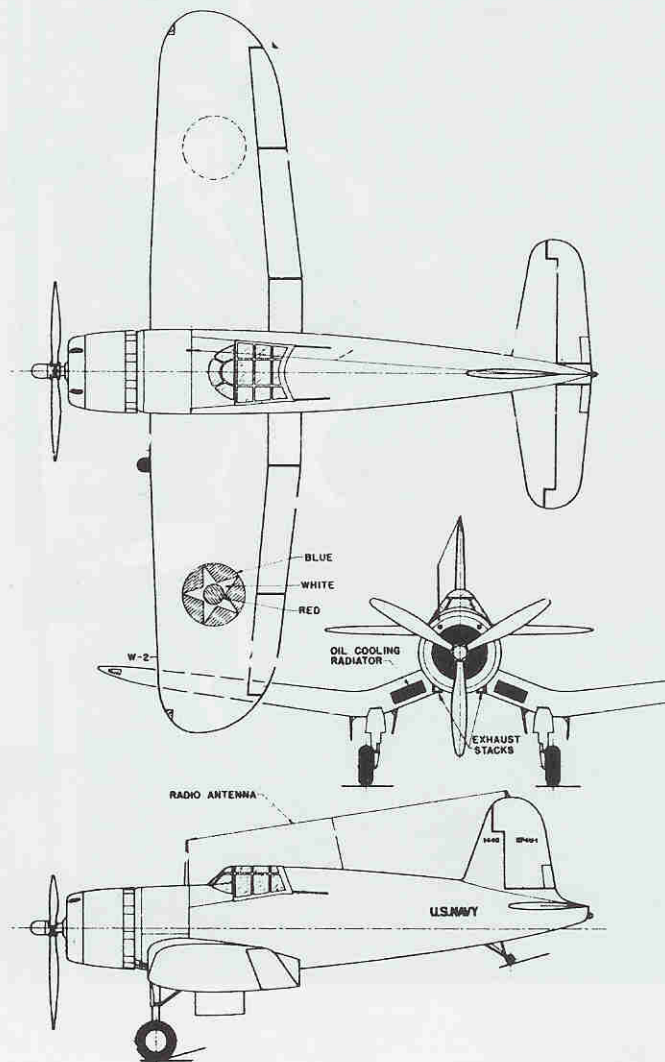



401 Janesville St.

**All rights reserved. No part of this book may be used or reproduced in any manner without the prior written permission of the publisher.**

## **AIRCRAFT MANUAL SERIES**

B-29 Superfortress  
B-26 Martin Marauder  
North American B-25 Mitchell Bomber  
B-24 Liberator  
B-17 Flying Fortress  
Lockheed P-38 Lightning  
Bell P-39 Airacobra  
Curtiss P-40 Warhawk  
Republic P-47 Thunderbolt  
Northrop P-61 Black Widow  
Bell P-63 Kingcobra  
Chance Vought F4U Corsair  
Grumman F6F Hellcat  
Grumman FM2 Wildcat  
F-82 Twin Mustang  
Lockheed F-80 Shooting Star  
Story of the Texan AT-6  
Flying Wings of Northrop  
Messerschmitt ME-262 Sturmvogel  
DeHavilland Mosquito  
Supermarine Spitfire  
Hawker Hurricane  
Ford Trimotor  
Curtiss Standard JN4-D Jenny  
X-15 Research Airplane

## **TECHNICAL & REFERENCE MANUALS**

Aircraft Detail Design Manual 2<sup>nd</sup> Ed.  
Aircraft Hardware Standards Manual & Engineering Reference  
Comprehensive Guide to Airfoil Sections for Light Aircraft  
Handbook of Airfoil Sections for Light Aircraft  
Helicopter Design and Data Manual  
World War II Intl. Aircraft Recognition Manual  
Curtiss OX-5 Aeronautical Engine  
J-3 Piper Cub Service Manual

**Published in the United States of America**

**By**

# **AVIATION**



**Publications**

**A Division of Graphic Communications Center, Inc.**

Box 357 Appleton, WI 54912-0357  
920/733-4483 FAX: 920/733-0676  
<http://www.hbs.net/gcc/>

ISBN 0-87994-026-3

© Copyright Aviation Publications 1989



Litho in U.S.A. at Graphic Communications Center  
Appleton, Wisconsin 54912

# Prologue

In 1938 it was very evident that a war in Europe was inevitable. The U.S. Navy realized that its carrier-based fighter aircraft was inferior in quality to that of the land-based Army equivalents. That year three fighter projects were started by the Navy Department to remedy this inadequacy. Bell Aircraft proposed a carrier version of the P-39 and Grumman built the XF5F-1, and Vought built the prototype of the Corsair called the XF4U-1. In flight testing the Corsair proved to be far superior.

As was the practice at the time, the airframes were designed around the existing engines, and the Corsair was built around the Pratt & Whitney R-2800 Double Wasp Radial. The same engine found in the Republic P-47 Thunderbolt. Big engines require big propellers, which require a high ground clearance, which in turn necessitate heavy and complicated landing gear mechanisms. This problem was partially solved in the P-47 by utilizing an hydraulic telescoping landing gear. A novel approach was used in the Corsair by employing an inverted gull-wing configuration which allowed a shorter and lighter landing gear and a less complicated retraction mechanism. The technical aeronautical description for this wing configuration is the "cranked wing" and a common example prior to the Corsair was Stuka Bomber.

The first production Corsair flew on 25 June, 1942. In September carrier landing tests were made and these were quite unsatisfactory, which then placed the F4U on a land-based status with the Marines. This proved to be a serious mistake, and certainly one which negated a great deal of expensive design and development in the folding wings. Carrier operations for the Corsair did not start until January of 1945. After carrier-based sorties commenced the F4U truly became the leading fighter of the Navy's Pacific War effort. A total of 2140 Japanese airplanes were destroyed by the Corsair with a corresponding loss of only 189 units for the Navy and Marines.

All airplanes are always in a state of modification and improvement, and this is especially true of military aircraft. The F4U was no exception to the rule. However, in comparison to other U.S. and British fighters, the modifications were not as drastic and the appearance of the F4U-1 was not greatly different than the last models used in Korea.

Three different manufacturers participated in the Corsair; Brewster built 735 units designated the F3A-1, and Goodyear built some 4,000 units designated the FG-1 and FG-2. Approximately 2,000 Corsairs were used by the New Zealand Air Force and carried the British name of Corsair I, II, III, and IV.

The length of time in which the Corsair was in actual production was the longest of any fighter in American history. Production started early in 1942 and the last model rolled off the assembly line on Christmas Eve, 1952. This was also the last piston engine fighter built in America. During its term of use it served under the American, British, French, Canadian, New Zealand, and Australian flags.

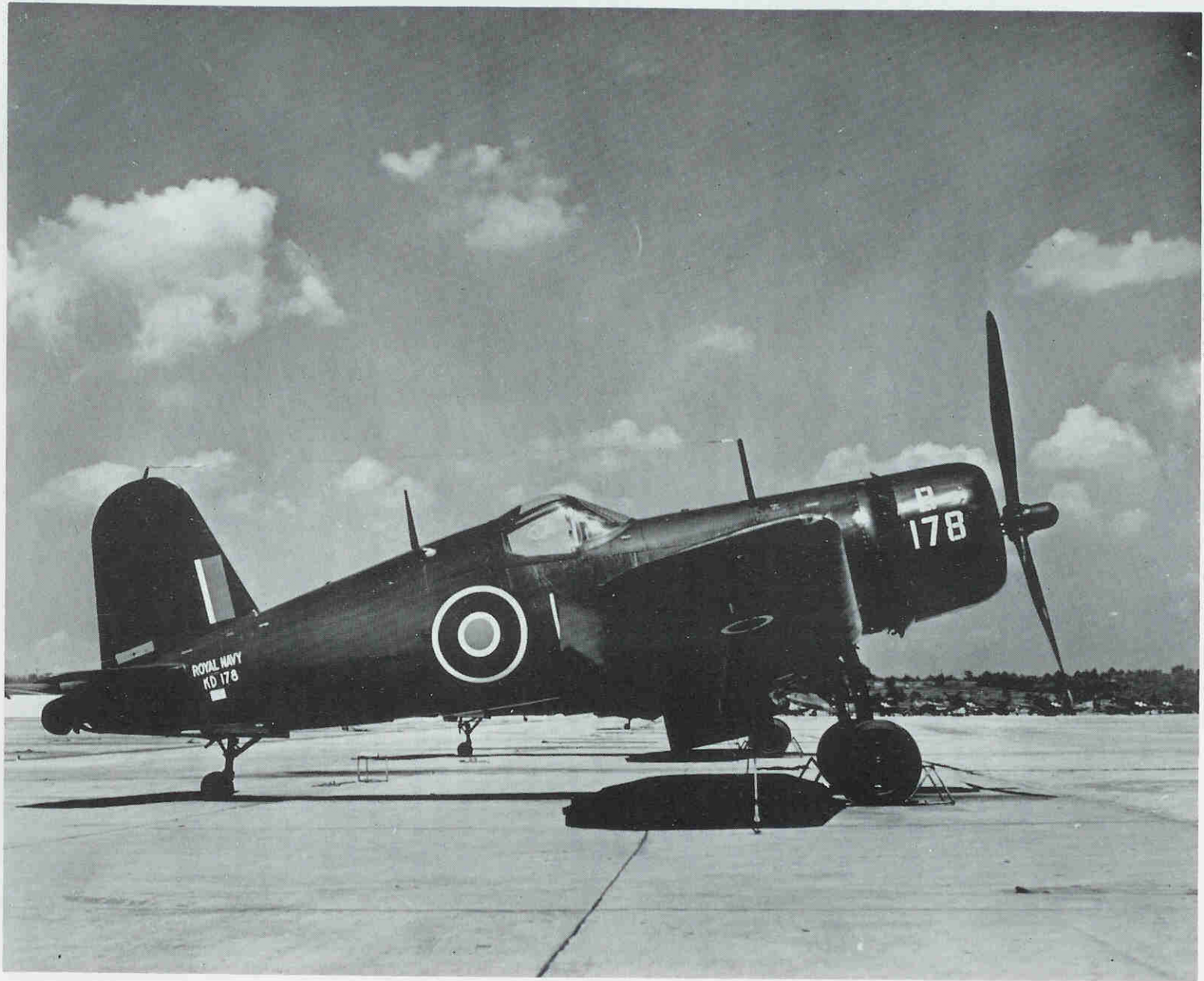

# Section I

## DESCRIPTION

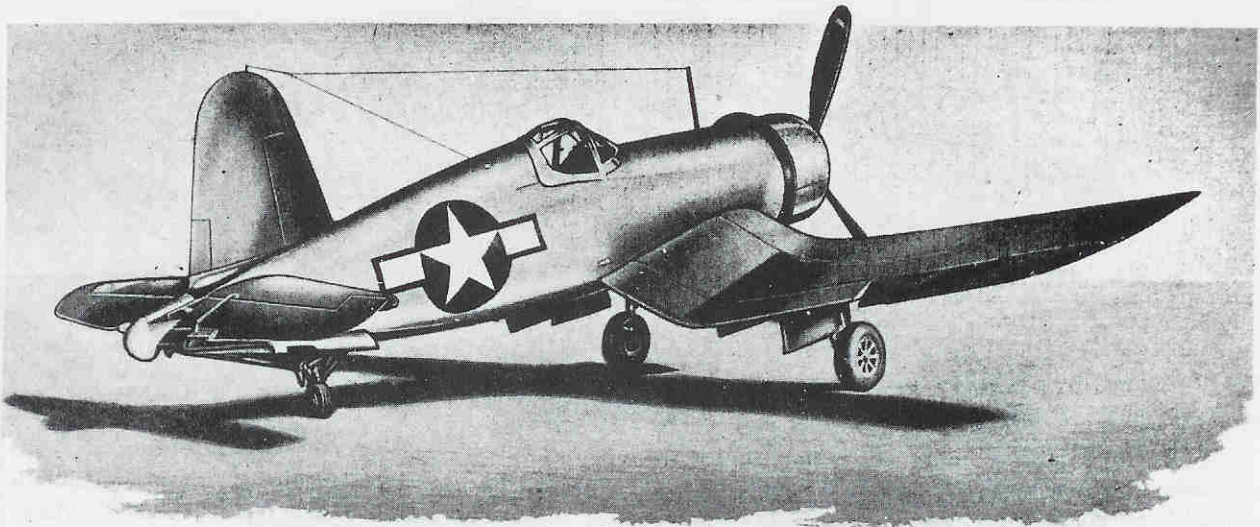

Fig. 1 — The Corsair

### 1. AIRPLANE.

a. GENERAL. — The Model F4U-1, FG-1, F3A-1 airplanes and British Corsair I, II, III airplanes are single-engine, single seat, folding low-wing monoplanes designed as carrier and land based fighters. The tactical mission of these airplanes is to serve as a protective escort on bombing raids, to attack and disperse enemy troops by gunfire, and to destroy enemy aircraft on the ground and in the air. These airplanes are designed to take off from land, or from the deck of an aircraft carrier with or without the aid of deck catapult, and to alight in an arresting gear or on land.

(1) The Model F4U-1D, F3A-1D, FG-1D airplanes and British serial number airplanes JT-555 and subsequent (center section twin pylons design) are equipped for operation as long range fighter-bombers when carrying either one or two 1000 pound bombs.

(2) The approximate overall dimensions for these airplanes in the three-point attitude are as follows:

Length.....	33 ft.
Height.....	12 ft.
Span.....	41 ft.

### BRITISH

Span.....	40 ft.
-----------	--------

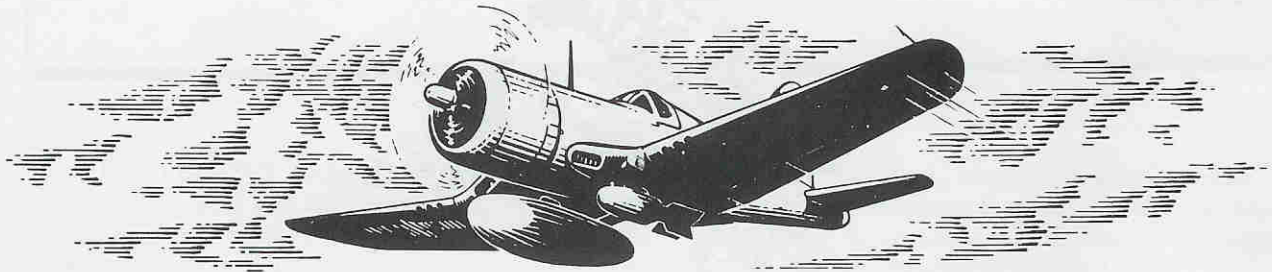

b. POWER PLANT.

RATING	BHP	RPM	AUX. SUPERCHARGER	ALTITUDE
NORMAL	1675	2550	"NEUTRAL"	S.L.-5500
	1625	2550	"LOW"	16500
	1550	2550	"HIGH"	22000
MILITARY (TIME LIMIT: 5 MIN.)	2000	2700	"NEUTRAL"	S.L.-1700
	1800	2700	"LOW"	16000
	1650	2700	"HIGH"	21000
TAKE-OFF	2000	2700	"NEUTRAL"	
WAR EMERGENCY (TIME LIMIT: 5 MIN.)	2250	2700	"NEUTRAL"	S.L.
	2135	2700	"LOW"	12500
	1975	2700	"HIGH"	17000

(1) ENGINE. — Pratt and Whitney Double Wasp; R-2800-8; two stage supercharged; two speed auxiliary stage; geared 2:1.

(2) PROPELLER. — Production airplanes are normally equipped with Hamilton Standard Hydro-matic three blade 6443A-21 or 6525A-21 propellers with a diameter of thirteen feet, four inches. Hamilton Standard propeller blades designated 6501A-0 and 6541A-0 having a diameter of thirteen feet, 1 inch may also be used on these airplanes. These latter propellers should be used whenever available since they improve performance.

(3) STARTER AND PRIMER.

(a) Eclipse, Type III, cartridge starter.

(b) Breech access door — Upper right hand accessory compartment.

(c) Starter switch — Electrical panel (right side of cockpit).

(d) Use Type "D" cartridges for starting under normal conditions. Type "E" may be used in

cold weather, or under other conditions when Type "D" cartridges are inadequate.

**NOTE**

The ignition booster is operated by the starter switch. Hold starter switch "ON" until engine is running smoothly. Model F4U-1 airplanes with serial numbers below 02443 (except 02264 and 02391) are equipped with booster coils; subsequent Model F4U-1 airplanes (except 02468, 02469, 02470, 02485, 02516, 02576, 02715, 02716 and 02722) are equipped with induction vibrators in lieu of booster coils. Model FG-1, F3A-1, and British Corsair I, II, III airplanes all are equipped with induction vibrators.

(e) The primer switch is located adjacent to the starter switch. The electric auxiliary fuel pump must be used to supply pressure for priming before starting the engine.





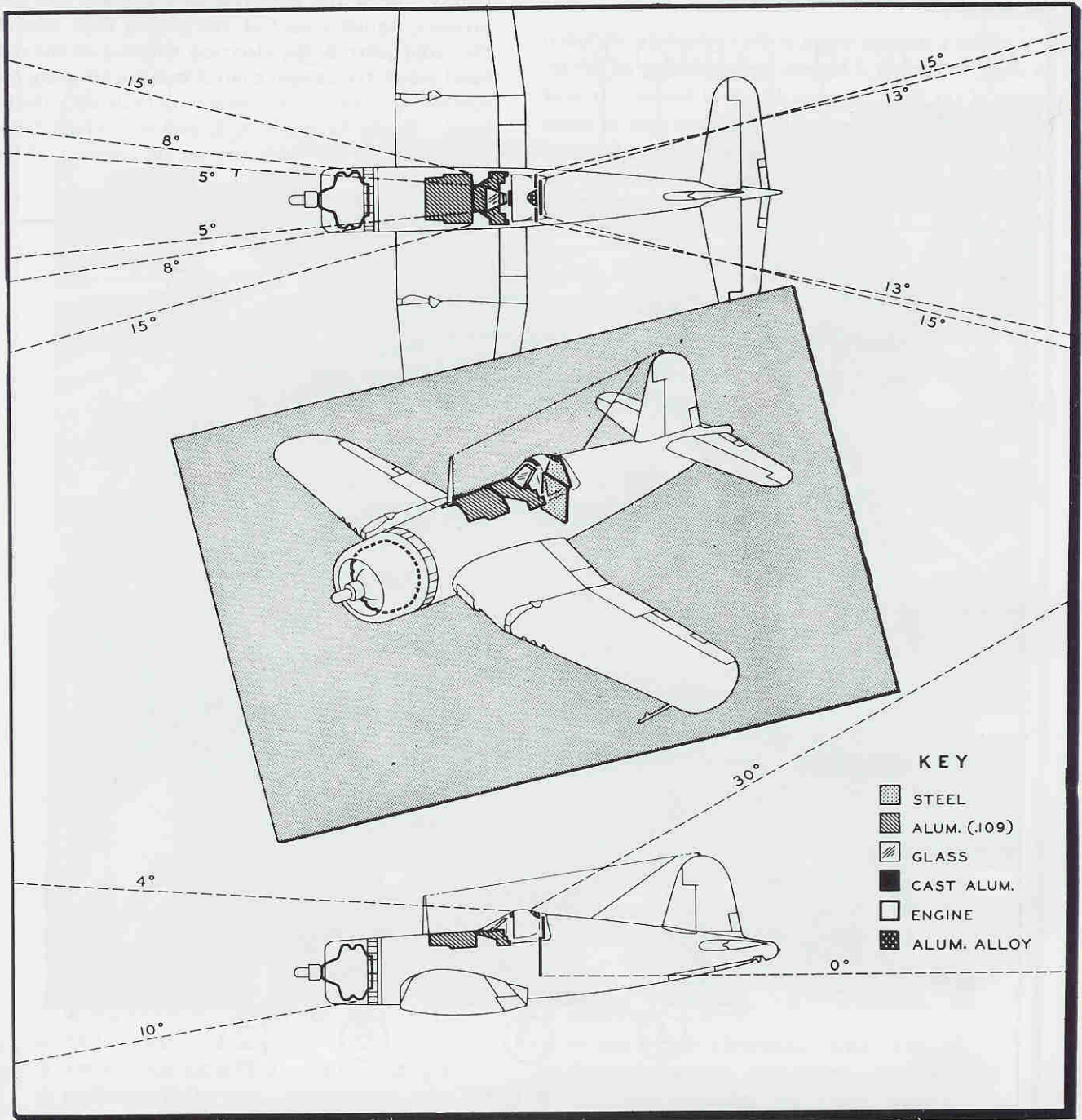

Fig. 2 — Angles of Armor Protection

c. PROTECTIVE ARMOR. — Armor is provided to protect the pilot and the fuel system. The pilot is protected from enemy fire originating within the areas graphically illustrated in figure 2. The fuel lines and main fuel tank are of self-sealing construc-

tion and, therefore, require no special armor plate protection; however, the main fuel tank has the additional protection of the hardened aluminum alloy cowl deck forward of the windshield.

## 2. COCKPIT ARRANGEMENT.

a. The following views of the cockpit are included in order to convey a clearer understanding of the location of the flight controls discussed herein. It is of utmost importance, especially to pilots new to these airplanes, that a thorough knowledge of the function and location of all controls and instruments be at-

tained. With the exception of the main fuel tank pressure regulator control, the cooling flaps controls, the radio controls, the electrical switches on the right hand panel, the oxygen control and the arresting gear control, all cockpit controls are operable with the left hand. Study figures 3, 4, 5, and 6 carefully before proceeding further with the textual content of this handbook.

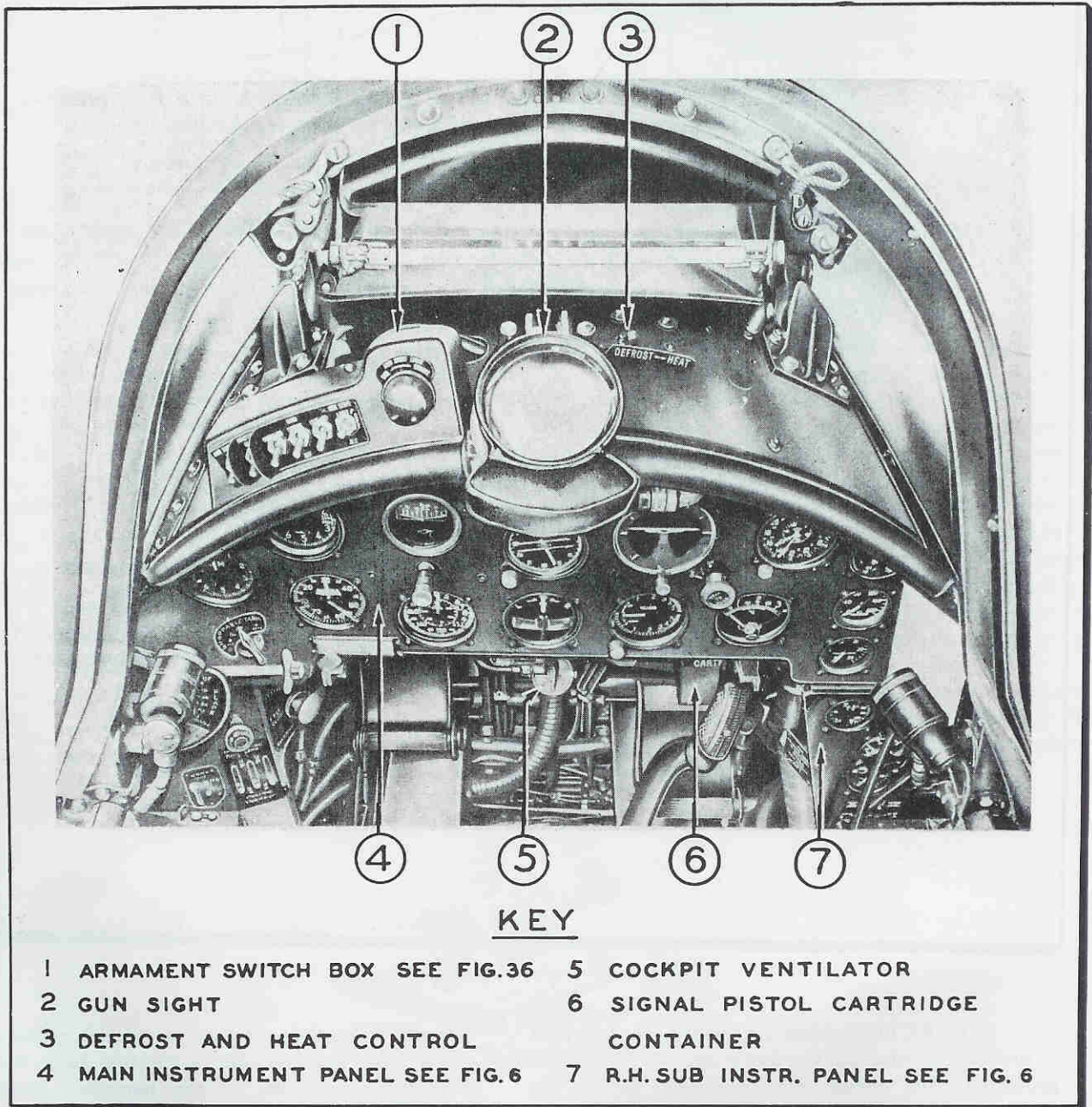
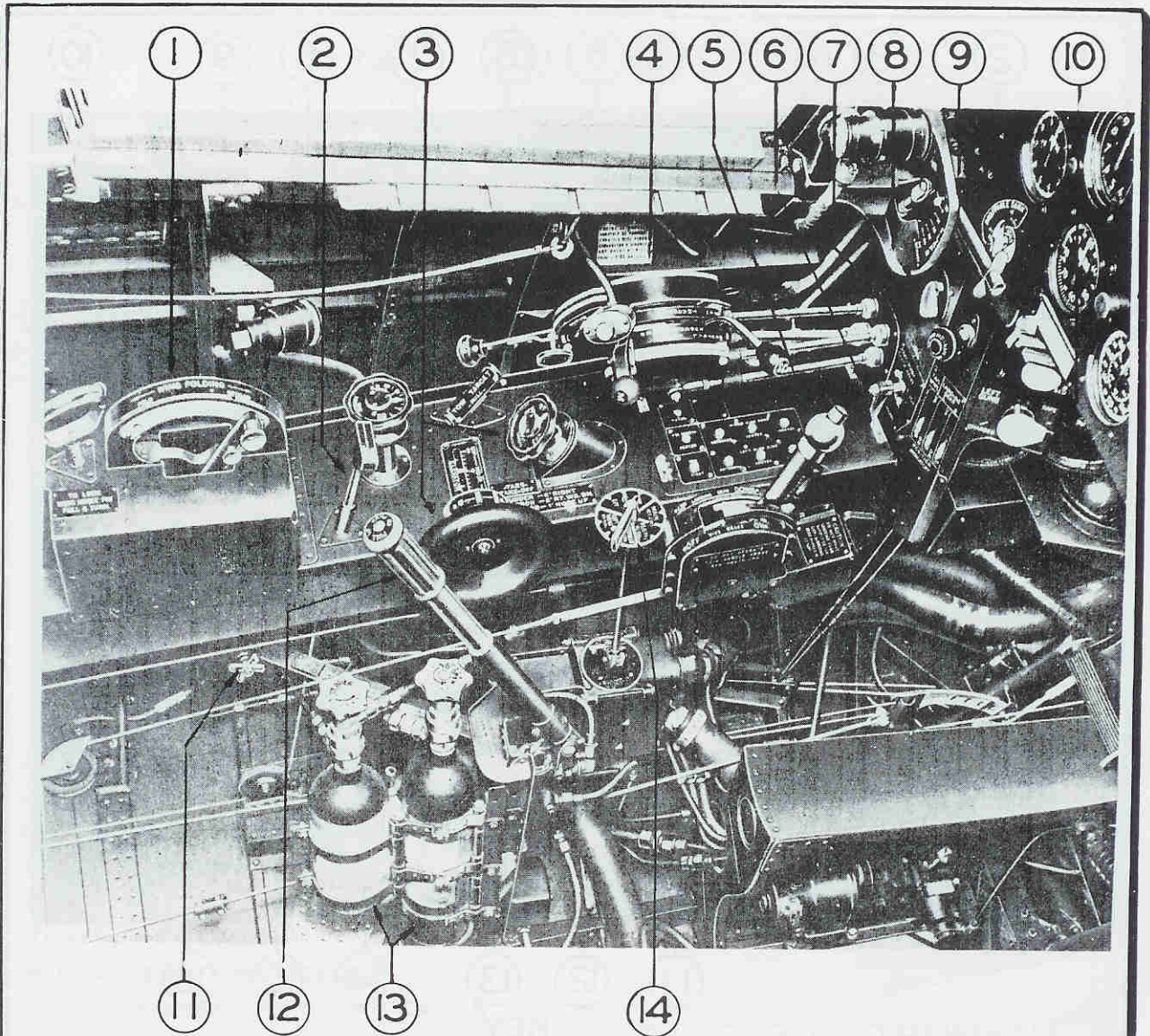

Fig. 3 — Cockpit — Forward



KEY

- |   |   |
|---|---|
| 1 WING FOLDING CONTROL SEE-FIG.16                     | 8 IGNITION SWITCH   |
| 2 TAIL WHEEL LOCK                                     | 9 WING FLAP CONTROL-SEE FIG. 15   |
| 3 TRIM TAB CONTROL-SEE FIG. 27                        | 10 GUN CHARGING CONTROL-SEE FIG. 18   |
| 4 ENGINE CONTROL UNIT-SEE FIG. 7                      | 11 CO <sub>2</sub> OVERBOARD RELEASE VALVE  |
| 5 LANDING GEAR AND DIVE<br>BRAKE CONTROL - SEE FIG.14 | 12 HYDRAULIC HAND PUMP  |
| 6 HAND PUMP CHECK VALVE-SEE FIG.19                    | 13 CO <sub>2</sub> BOTTLES - EMERGENCY LANDING<br>GEAR & VAPOR DILUTION-SEE FIG. 30 |
| 7 CARBURETOR AIR CONTROL-SEE FIG. 8                   | 14 FUEL SELECTOR  |

Fig. 4 — Cockpit — Left Hand Side — Seat Removed

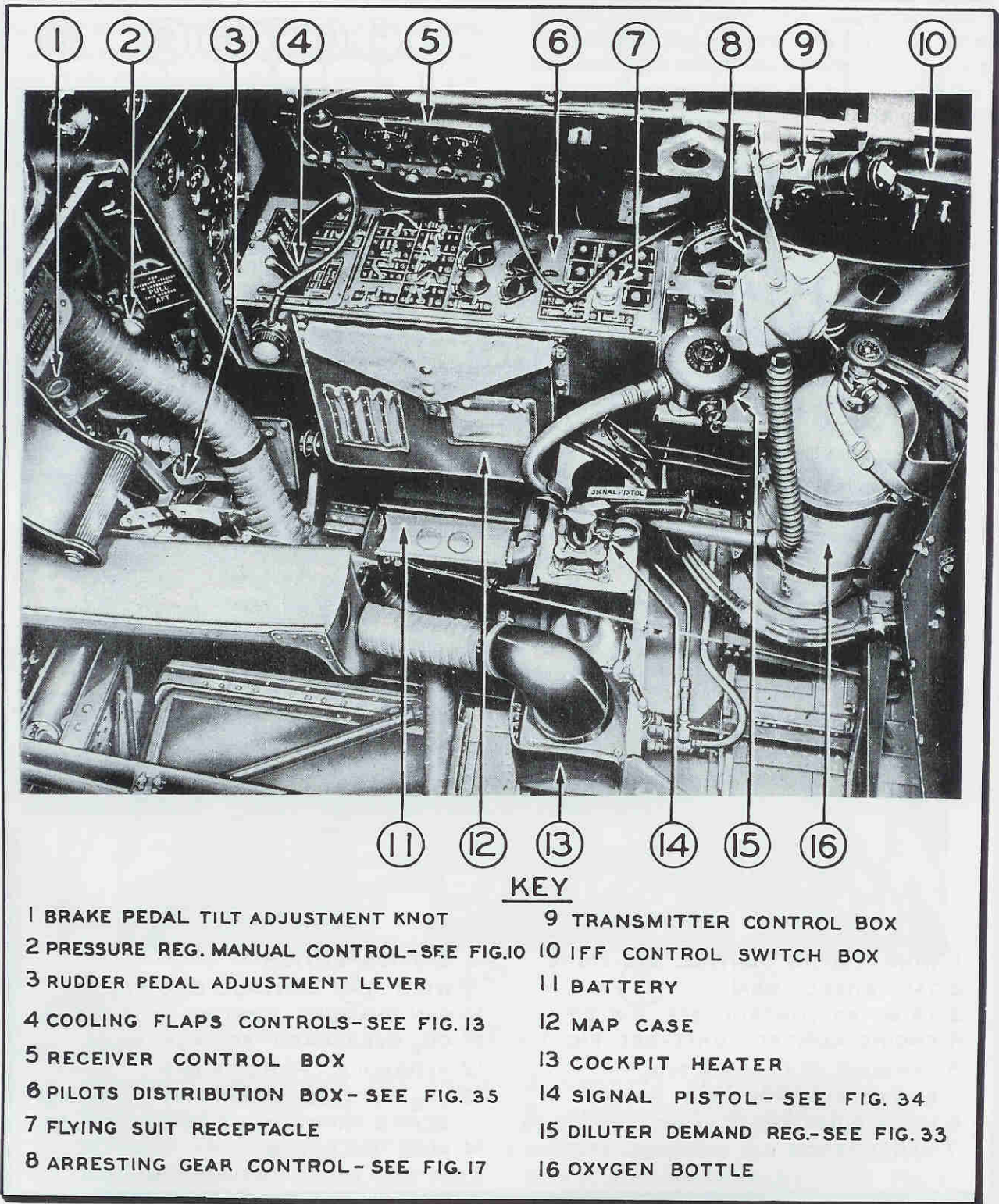
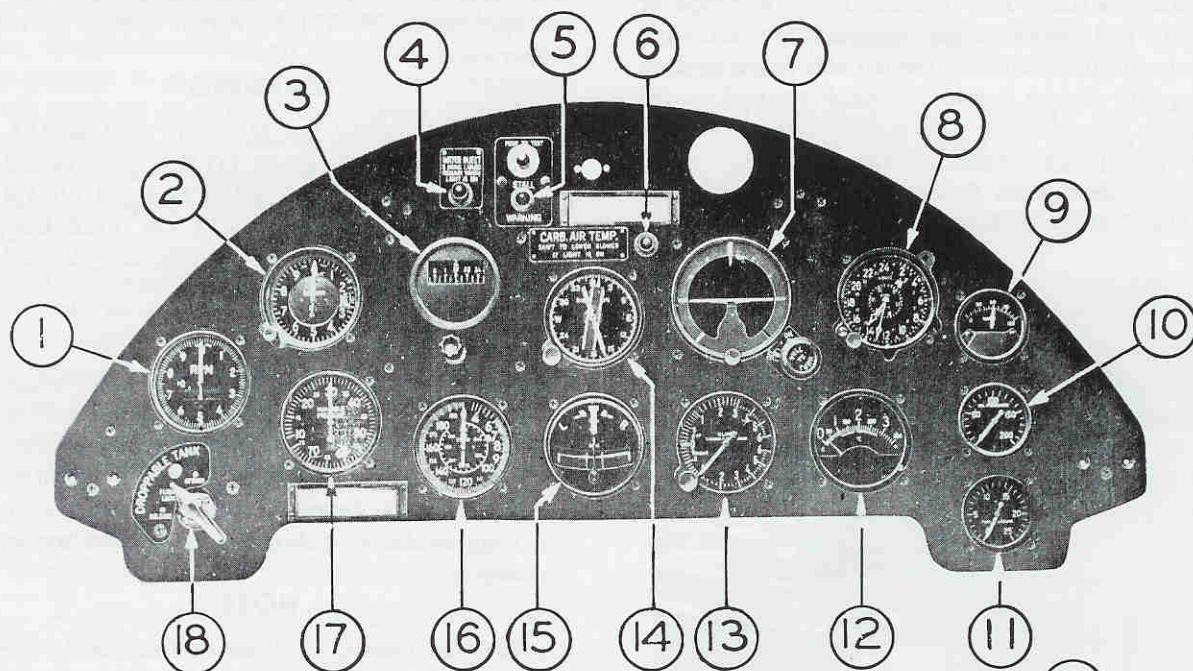

Fig. 5 — Cockpit — Right Hand Side — Seat Removed



MAIN INSTRUMENT PANEL

KEY

- 1 TACHOMETER
- 2 ALTIMETER
- 3 DIRECTIONAL GYRO
- 4 WATER INJECTION QUANTITY WARNING LIGHT
- 5 STALL WARNING LIGHT
- 6 CARBURETOR AIR TEMP. WARNING LIGHT
- 7 GYRO HORIZON
- 8 ELAPSED TIME CLOCK
- 9 OIL TEMPERATURE INDICATOR
- 10 OIL PRESSURE GAGE
- 11 FUEL PRESSURE GAGE
- 12 CYLINDER TEMPERATURE INDICATOR
- 13 CLIMB INDICATOR
- 14 COMPASS
- 15 TURN AND BANK INDICATOR
- 16 AIRSPEED INDICATOR
- 17 MANIFOLD PRESSURE GAGE
- 18 DROPPABLE FUEL TANK SWITCH

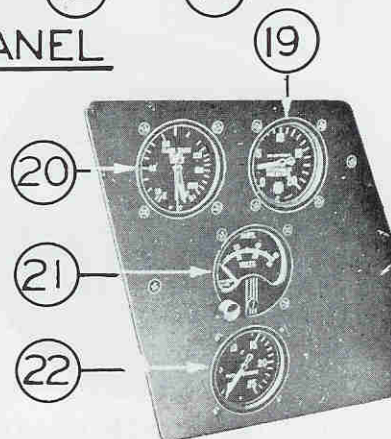

R.H. SUB-INSTRUMENT PANEL

- 19 HYDRAULIC PRESSURE GAGE
- 20 FUEL QUANTITY GAGE
- 21 VOLT - AMMETER
- 22 FUEL TANK PRESSURE GAGE

Fig. 6 — Instrument Panels

### 3. ENGINE CONTROLS.

a. GENERAL.—The throttle, mixture, propeller governor, and supercharger controls are arranged in a control unit installed on the left side of the cockpit as shown in figures 4 and 7. Each control moves through a quadrant in operation. Other controls necessary to proper engine operation are the carburetor air control, cowl flap control, intercooler flap control, and oil cooler flap control.

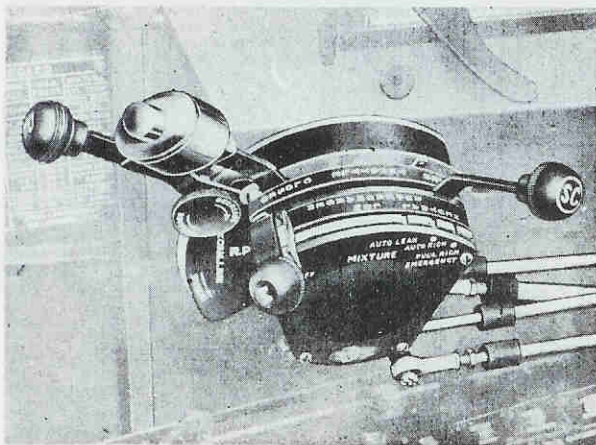

Fig. 7.—Engine Control Unit

(1) THROTTLE CONTROL.—In addition to normal function the throttle control operates the water injection switch. Moving the throttle control full forward (breaking the safety-wire stop) operates a micro switch and turns the water injection equipment "ON." When the throttle control is in any other position the water injection equipment is "OFF."

(2) MIXTURE CONTROL.—This engine is equipped with a PT-13D4 (PT-13D6 on airplanes with water injection system) Bendix-Stromberg injection carburetor with automatic mixture control. The mixture control has four positions, "EMERGENCY RICH," "AUTO RICH," "AUTO LEAN," and "IDLE CUT-OFF." Fuel will be discharged from the carburetor at any fuel pressure above five pounds per square inch when the mixture control is not in the "IDLE CUT-OFF" position. To prevent flooding through inadvertent use of the auxiliary fuel pump, the mixture control shall always be left in "IDLE CUT-OFF" when the engine is not running. For all ground operation and for flight operations above 65 per cent rated power, the control shall be set in "AUTO RICH." For cruising operation at 65 per cent power and below, the control should be set at

"AUTO LEAN." If it is impossible to maintain cylinder head temperatures below 232°C. (450°F.) without opening the cowl flaps, enrich enough to restore proper cooling.

#### WARNING

EMERGENCY RICH POSITION SHALL NOT BE USED, DUE TO EXCESSIVELY RICH MIXTURES WHICH RESULT IN CUTTING IN AND OUT OF THE ENGINE, THEREBY CAUSING VERY ROUGH OPERATION.

#### NOTE

When adjusting the mixture control, make sure the control is set properly by feeling for the "notch" which indicates correct positioning of the carburetor lever. Control backlash may result in these positions being slightly different from the quadrant markings.

#### NOTE

Manual leaning may be carried out to the limit of stable operation at 50 per cent power and below, but manifold pressure limits given for "AUTO LEAN" apply also to manual lean operation.

#### (3) PROPELLER GOVERNOR CONTROL.—

The constant speed propeller control is located on the after end of the engine control quadrant. Move the control "DOWN" to "INCREASE" rpm; move the control "UP" to "DECREASE" rpm. "FULL DOWN" position gives take-off rpm; "FULL UP" position give approximately 1200 rpm. Vernier adjustment is obtained by rotating the knob on the control lever.

(a) The control sets the constant speed unit and has no direct control over propeller blade angle. The blade angle is such that 2700 rpm can be obtained at somewhat less than full power, and 3060 rpm will not be exceeded in dives up to maximum allowable diving speed. Rapid changes in throttle or propeller control setting will tend to cause the rpm to "overshoot the mark" momentarily before settling down.

(b) A hydraulic accumulator is connected to the propeller oil system to provide a reserve supply of oil to the governor at sufficient pressure to change propeller blade angle when the normal supply is interrupted for any reason. Accumulator pressure should be checked each day prior to flight. The pressure should be 300 pounds per square inch with engine not running.

(4) **SUPERCHARGER CONTROL.**—The two stage supercharger induction system installation is shown diagrammatically on figure 9. The main stage impeller is geared directly to the crankshaft, and the auxiliary stage impeller is driven through oil-operated clutches by means of which it can be disconnected from the crankshaft (“NEUTRAL”) or engaged in either of two fixed gear ratios (“LOW” or “HIGH”).

(a) The purpose of the auxiliary stage impeller is to supply air to the carburetor at approximately sea level pressure when operating at altitude. The auxiliary stage supercharger regulator maintains this condition by gradually opening the auxiliary stage gate valves, at the entrance to the auxiliary supercharger, as the altitude increases.

1. On airplanes equipped with a water injection system, the auxiliary stage supercharger regulator is sensitive to impact pressure of the carburetor.

2. On airplanes not equipped with a water injection system, the auxiliary stage supercharger regulator is sensitive to auxiliary stage outlet pressure, transmitted through a cored passage to the regulator.

(b) The heat produced by compressing the intake air in the auxiliary supercharger is partially dissipated in the intercoolers, reducing the temperature of the intake air before it enters the carburetor. (See paragraph 3. a. (8). Do not use “LOW” blower when the desired power can be obtained in “NEUTRAL” (or “HIGH” when the desired power can be obtained in “LOW”) except as noted in paragraph 3. a. (5). High carburetor air temperature and uneconomical fuel consumption will result.

(c) Do not shift the supercharger control more often than at five minute intervals, except in an emergency, to allow the dissipation of heat from the clutches. The supercharger control must be properly positioned to prevent clutch slippage and to insure the availability of rated power at all times. If practicable, the engine should be operated for at least five minutes in each of the supercharger control settings during each five hour period of operation.

(d) To shift from “NEUTRAL” to “LOW” or from “LOW” to “HIGH,” the following procedure shall be used:

1. Mixture control in “AUTO RICH.”
2. Close throttle, as necessary, to avoid exceeding desired manifold pressure after shift (see Specific Engine Flight Chart, Section III).
3. Reduce rpm, if practicable.

4. Shift rapidly.

5. Readjust rpm and throttle to obtain desired power.

(e) To shift from “HIGH” to “LOW” or from “LOW” to “NEUTRAL,” the following procedure shall be used:

1. Mixture control in “AUTO RICH.”
2. Shift rapidly.
3. Readjust rpm and throttle to obtain desired power.

(5) **CARBURETOR AIR CONTROL (“ALTERNATE AIR”).**—The carburetor air control is located adjacent to the ignition switch on the lower left side of the instrument panel. Operation of the control, which is to be used in “NEUTRAL” blower only, is as follows:

(a) “DIRECT” — “FULL IN.”

(b) “ALTERNATE” — “FULL OUT.”



Fig. 8 — Carburetor Air Control

1. This control should be used to provide a warm, moisture-free source of carburetor air when icing conditions are suspected. At all other times the control shall be in the “DIRECT” position, especially when starting, since, if set to “ALTERNATE,” a path directly to the engine compartment is opened for backfire. Above 2000 feet “LOW” blower can be used, with the intercooler flap closed and the carburetor air control “FULL IN,” to supply heated air to the carburetor.

#### NOTE

The carburetor air control shall be either “FULL IN” or “FULL OUT.” Intermediate positions shall not be used.

**(6) CARBURETOR AIR TEMPERATURE.**

A warning light is provided on the main instrument panel to indicate (red light "ON") if the carburetor air temperature exceeds the maximum limit of 43°C. (109°F.) Operating the engine at high power with excessively high carburetor air temperature (red light "ON") will probably cause detonation and serious damage to the engine except when operating at war emergency power. Detonation may be indicated by a slight undue roughness increasing somewhat in severity in a few seconds, and by an appreciable and sudden rise in cylinder head temperature, if the offending cylinder happens to be the one connected to the temperature gage (No. 4 cylinder head).

**NOTE**

When operating at war emergency power, an anti-detonant is used. Because of this, the carburetor air temperature warning light may be "ON" without fear of detonation and possible damage to the engine.

(a) Control of the carburetor air temperature when operating in "LOW" or "HIGH" blower is provided by means of the intercooler flap. The following flap settings should be used:

1. Normal climb or maneuvers — "½ OPEN."
2. Severe operating conditions and maneuvers — "WIDE OPEN."
3. Level flight — "CLOSED."

**NOTE**

If the warning light comes on when operating in "LOW" or "HIGH" blower at low speeds, immediately open the intercooler flap wide.

(b) Excessively high carburetor air temperature is most likely to occur during high power, high rpm, low air speed operation (as in steep climb or in tight turns) with the intercooler flap "CLOSED." The warning light is especially likely to come on if the supercharger control is shifted to a higher blower ratio at too low an altitude. In this case, immediately shift back to the next lower blower ratio.

(c) If high carburetor air temperature is encountered (red warning light "ON") well above the normal supercharger control shift altitude, it may be possible to reduce the temperature to normal by the following steps without incurring the power loss incident to shifting to the next lower blower:

1. Open intercooler flap (effective only if operating at high power and comparatively low air speed).

**NOTE**

At high air speed, little improvement in intercooling is obtained by opening the intercooler flap because, under this condition with the flap closed, the heat transfer to the cooling air is already very close to the maximum that can be obtained at any flow of the cooling air.

2. IMMEDIATELY after opening the intercooler flap reduce throttle setting by approximately four inches Hg. manifold pressure (to reduce danger of damage to the engine due to detonation).

3. Reduce rpm by approximately 150. If the above do not reduce the carburetor air temperature to normal (red warning light "OUT"), then the pilot must immediately —

4. Shift to the next lower blower setting and increase rpm and throttle to the desired setting.

(d) In view of the above, the warning light is placarded as follows: "SHIFT TO LOWER BLOWER IF LIGHT IS ON" since this is the best and most positive means of reducing the carburetor air temperature to normal.

(7) COWL FLAP CONTROL AND CYLINDER TEMPERATURES.—The cowl flap control is located on the right side of the cockpit, forward of the electrical panel (see figures 5 and 13).

**NOTE**

Hold either "OPEN" or "CLOSED" until desired setting is obtained, then release.

(a) The cowl flaps should be adjusted so as not to exceed the following cylinder head temperatures:

1. Take-off, military, and war emergency power — 260°C. (500°F.)
2. High speed and climb at normal rated power — 260°C. (500°F.)
3. Continuous operation at any power except as above — 232°C. (450°F.).

(b) The "FULL OPEN" setting of cowl flaps is provided primarily for ground cooling. If this setting is used in flight, buffeting of the tail surfaces will result. Open about 2/3 for take-off and climb, and close (or open slightly, if required) for high speed



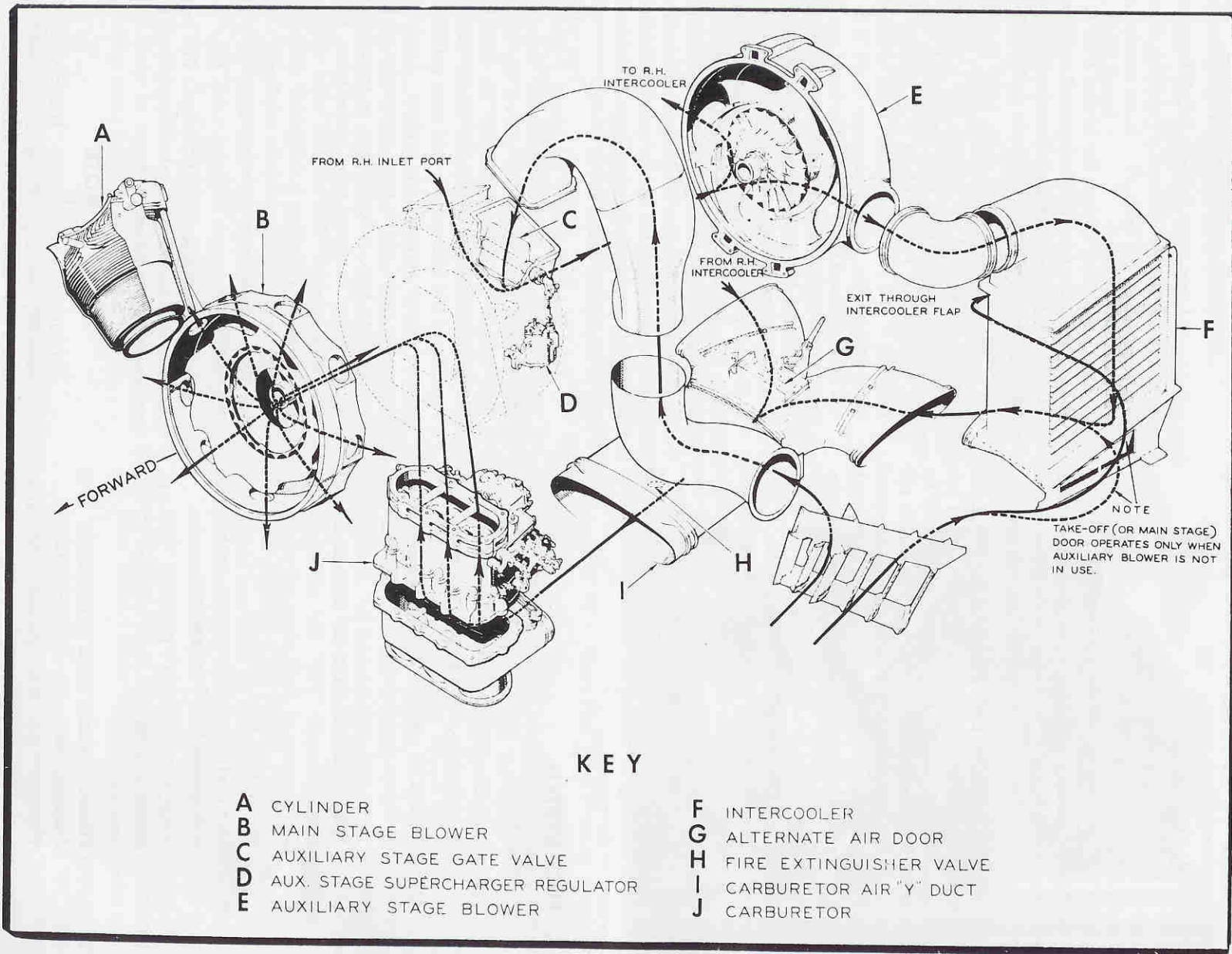

KEY

- |   |                                   |   |                         |
|---|-----------------------------------|---|-------------------------|
| A | CYLINDER                          | F | INTERCOOLER             |
| B | MAIN STAGE BLOWER                 | G | ALTERNATE AIR DOOR      |
| C | AUXILIARY STAGE GATE VALVE        | H | FIRE EXTINGUISHER VALVE |
| D | AUX. STAGE SUPERCHARGER REGULATOR | I | CARBURETOR AIR "Y" DUCT |
| E | AUXILIARY STAGE BLOWER            | J | CARBURETOR              |

Fig. 9 — Induction System

and cruising level flight. Cylinder head temperatures can be reduced by:

1. Enriching mixture.
2. Opening cowl flaps.
3. Reducing power.
4. Increasing climbing air speed.

(c) Climbing at speed slightly greater than best climbing speed will have very little effect on the rate of climb. Better all around cooling will result.

(8) **INTERCOOLER FLAP CONTROL.** — Control of the carburetor air temperature when operating in "LOW" or "HIGH" blower is provided by means of the intercooler flap control, located on the right side of the cockpit forward of the electrical panel (see figures 5 and 13). Refer to paragraph 3. a. (6) for further information concerning the intercooler flap control.

(9) **OIL COOLER FLAP CONTROL.** — The quantity of cooling air to be admitted to the oil coolers is regulated by two flaps controlled from the right side of the cockpit (see figures 5 and 13). The two flaps may be placed in any position between "OPEN" and "CLOSED," as required to effect the flow of the necessary quantity of cooling air through the airduct opening to the coolers.

#### 4. FUEL SYSTEM.

##### a. GENERAL.

- (1) **FUEL.** — Grade: 100/130.  
Specification: AN-F-28.

(2) **CAPACITY** (Model F4U-1, F3A-1, FG-1 airplanes and British serial number JT-100 to JT-554 airplanes):

Normal fighter: 178 U. S. gallons (148 Imp. gallons).

Overload fighter (full tanks): 363 U.S. gallons (302 Imp. gallons).

Overload fighter (droppable tank): 535 U.S. gallons (446 Imp. gallons).

(3) **CAPACITY** (Model F4U-1D, F3A-1D, FG-1D airplanes and British serial number JT-555 and subsequent airplanes):

Normal fighter: 178 U.S. gallons (148 Imp. gallons).

Fighter: 237 U.S. gallons (197 Imp. gallons).

Long range fighter or fighter-bomber: 391 U.S. gallons (327 Imp. gallons).

Long range fighter: 545 U.S. gallons (454 Imp. gallons).

##### b. TANKS.

(1) The fuel system for Model F4U-1, F3A-1, FG-1 airplanes and British airplanes, serial numbers JT-100 to JT-554 inclusive (prior to center section twin pylons installation), is shown on figure 11.

(a) The self-sealing main tank, located in the fuselage, forward of the cockpit, has a total capacity of 237 U.S. gallons (197 Imp. gallons) of fuel, including a standpipe reserve of 50 U.S. gallons (42 Imp. gallons). The two wing tanks, built integrally with the outer panels, have a capacity of 63 U.S. gallons (53 Imp. gallons) each. The wing tanks are provided with a CO<sub>2</sub> vapor dilution system. Provision is made, under the fuselage, for the installation of a droppable auxiliary tank having a capacity of 170 U.S. gallons (142 Imp. gallons) of fuel. The main fuel tank maintains a standpipe reserve of 50 U.S. gallons of fuel (42 Imp. gallons) after the fuel supply through the main line is exhausted. Bear in mind that the reserve fuel is made available as the quantity necessary for final operation before landing, when the main fuel supply is exhausted, and as noted below.

(2) The fuel system for Model F4U-1D, F3A-1D, FG-1D and British airplanes, serial number JT-555 and subsequent, is shown on figure 11A. This system includes provisions for installing two Navy standard-type droppable tanks, each with a capacity of 154 U.S. gallons (129 Imp. gallons) of fuel, on the center section twin pylons. Lockheed-type droppable tanks which have a capacity of 170 U.S. gallons (142 Imp. gallons), may be installed in place of the Navy Standard-type tanks when the latter are not available. The original main tank and the provisions for installing a droppable tank under the fuselage are retained on these airplanes. However, the two wing tanks and their vapor dilution system are eliminated.

c. **FUEL TANK SELECTOR.** — The respective fuel selectors for the fuel systems described above are shown on figures 11 and 11A.

#### NOTE

Set fuel tank selector on "RESERVE" for take-off, landing, diving and maneuvers.  
DO NOT CRUISE ON "RESERVE."

*d.* DROPPABLE TANK RELEASE.

(1) The release for the center droppable tank (under fuselage) is located on the left side of the main instrument panel. To drop the tank, turn the switch to "RELEASE."

(2) The manual release controls for bombs and drop tanks installed on the twin pylons are located to the left of the pilot's seat. To effect release of either a bomb or a tank, select the proper release control, "RIGHT" or "LEFT" wing as shown on the nameplate, and pull the control to its limit of extension. See Section V, paragraph 5*a.* (5) for information on electrical release.

**NOTE**

Selection of the manner of release (manual or electrical) will depend on the type of bomb adapter installed on the particular airplane.

*e.* FUEL QUANTITY GAGE. — An electrical fuel quantity gage is provided for the main tank only; it shows the total quantity of fuel in the tank, including the standpipe reserve. The gage dial is calibrated to indicate correctly with the airplane in level flight at approximately 175 knots indicated air speed, normal fighter load.

*f.* VAPOR RETURN. — The vapor return line, running from the carburetor to the top of the main fuel tank, returns approximately two quarts of fuel to the main tank in an hour of normal engine operation.

*g.* ELECTRIC AUXILIARY FUEL PUMP. — The electric auxiliary fuel pump switch is located on the pilot's right hand panel (see figure 35).

(1) The pump is used for:

- (*a*) Starting.
- (*b*) Take-off and landing.
- (*c*) Changing from one tank to another.
- (*d*) After failure of engine-driven fuel pump.
- (*e*) To maintain fuel pressure during high-power, high altitude operation. This condition is most likely to occur in summer operation, and is caused by vapor formation in the fuel lines.

**NOTE**

For high-power operation at high-altitude it is advisable to leave the electric auxiliary fuel pump "ON."



*Fig. 10 — Main Fuel Tank Pressure Regulator*

*h.* MAIN TANK PRESSURIZING. — Provision is made for pressurizing the main tank to prevent the loss of fuel pressure and consequent unsatisfactory engine operation at high altitudes due to vaporization of fuel. An automatic cut-off valve, set to operate at approximately 12,000 feet, turns the pressure "ON" above this altitude and "OFF" below this altitude. A manual shut-off control is also provided for turning the tank pressure "OFF." This control should be left "ON" (forward) at all times, except when the main tank is punctured in combat, when tank pressure is not required to maintain satisfactory engine operation at combat altitude, or as an additional safeguard in the event of a forced landing under adverse conditions. The manual control for the main tank pressure regulator is located on the forward right hand side of the cockpit, below the main instrument panel. Refer to figure 5.

*i.* WING TANK VAPOR DILUTION SYSTEM OPERATION. — Provision is made, on airplanes having outer panel integral wing tanks, for making the atmosphere above the fuel inert, for protection from gunfire during combat, by admitting CO<sub>2</sub> to the wing

tanks. To operate, turn the knob located below the elevator tab control approximately one full turn counterclockwise (see figures 30 and 4).

### NOTE

This system does not force fuel out of the tanks.

### WARNING

The vapor dilution system must not be used when operating on fuel from the outer panel tanks. Injection of CO<sub>2</sub> would result in an interruption of fuel flow through the lines. However, use of the vapor dilution system does not render the gasoline in the outer panel tanks unfit for further use.

## 5. OIL SYSTEM.

*a.* GENERAL. — The oil system is shown on figure 12.

(1) OIL. — Grade: 1100.

Specification: AN-VV-0-466a.

(2) CAPACITY:

Normal fighter: 12 U.S. gallons (10 Imp. gallons).

Overload fighter (full tank): 20 U.S. gallons (17 Imp. gallons).

Overload fighter (large oil tank): 24 U.S. gallons (20 Imp. gallons).

*b.* OIL TANK. — The oil tank is located just forward of the firewall, and is supported by brackets mounted on the firewall.

*c.* OIL COOLERS. — The oil coolers, mounted just aft of the airduct openings in the wings, are provided with thermostatic regulator valves set to maintain the oil temperature at 60-80°C. (140-176°F.).

## 6. OIL DILUTION SYSTEM.

*a.* The oil dilution switch is located on the right hand panel in the cockpit. The purpose of oil dilution is to reduce the cranking torque of the engine and to provide a sufficient amount of low viscosity oil for lubrication when starting an engine at temperatures near or below the pour point of the oil. This is accomplished by diluting the oil in the engine and quick warm-up circuit of the oil system with gasoline in the manner described in Section II, paragraph 5. *a.* prior to stopping the engine. Oil dilution can be effected only when the engine is running. Never dilute subsequent to starting a cold engine having undiluted oil as it will not be of any aid in starting and may cause trouble.

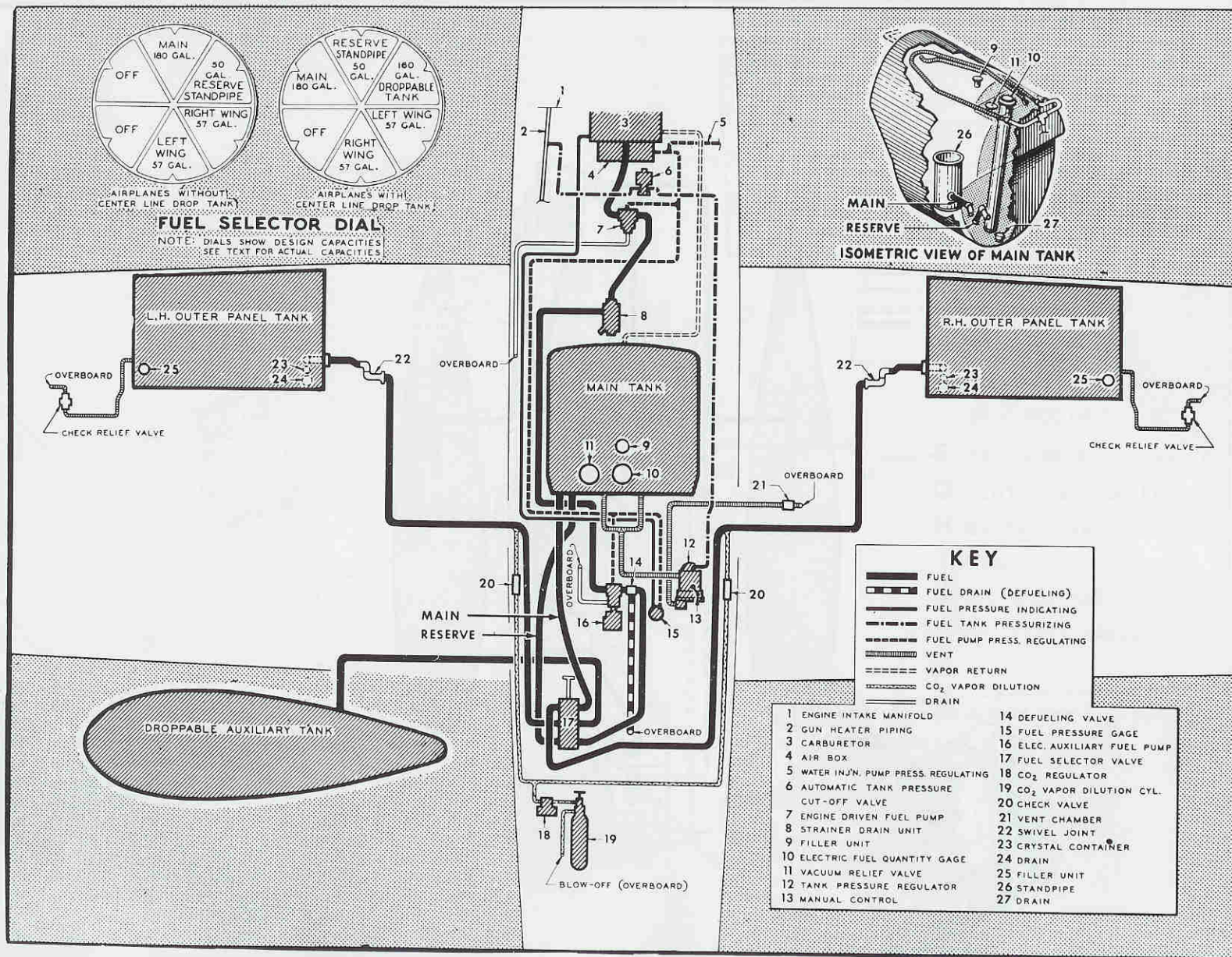

Fig. 11 — Fuel System on Airplanes Prior to Installation of Twin Pylon Droppable Tanks

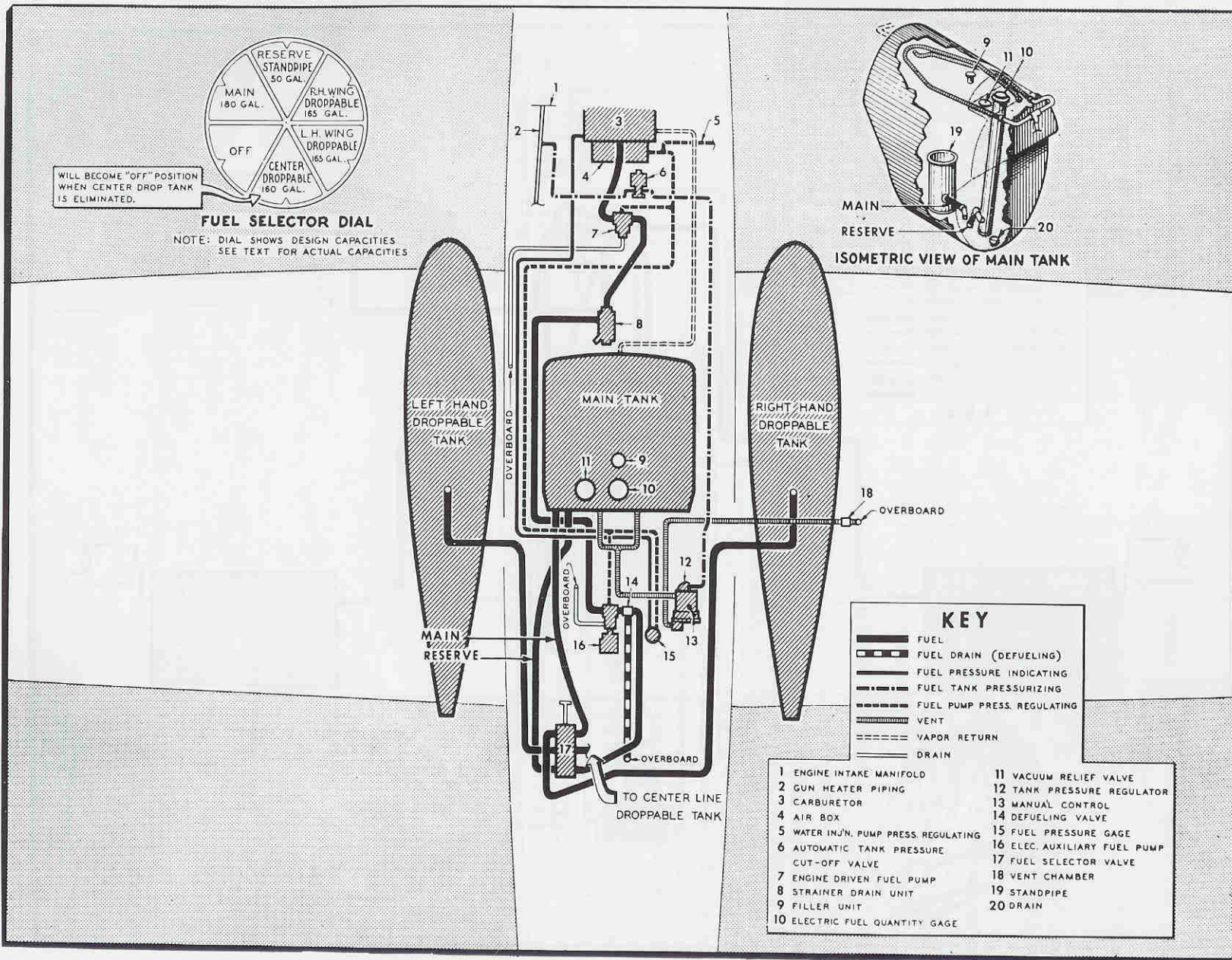

Fig. 11A — Fuel System on Airplanes with Twin Pylon Droppable Tanks

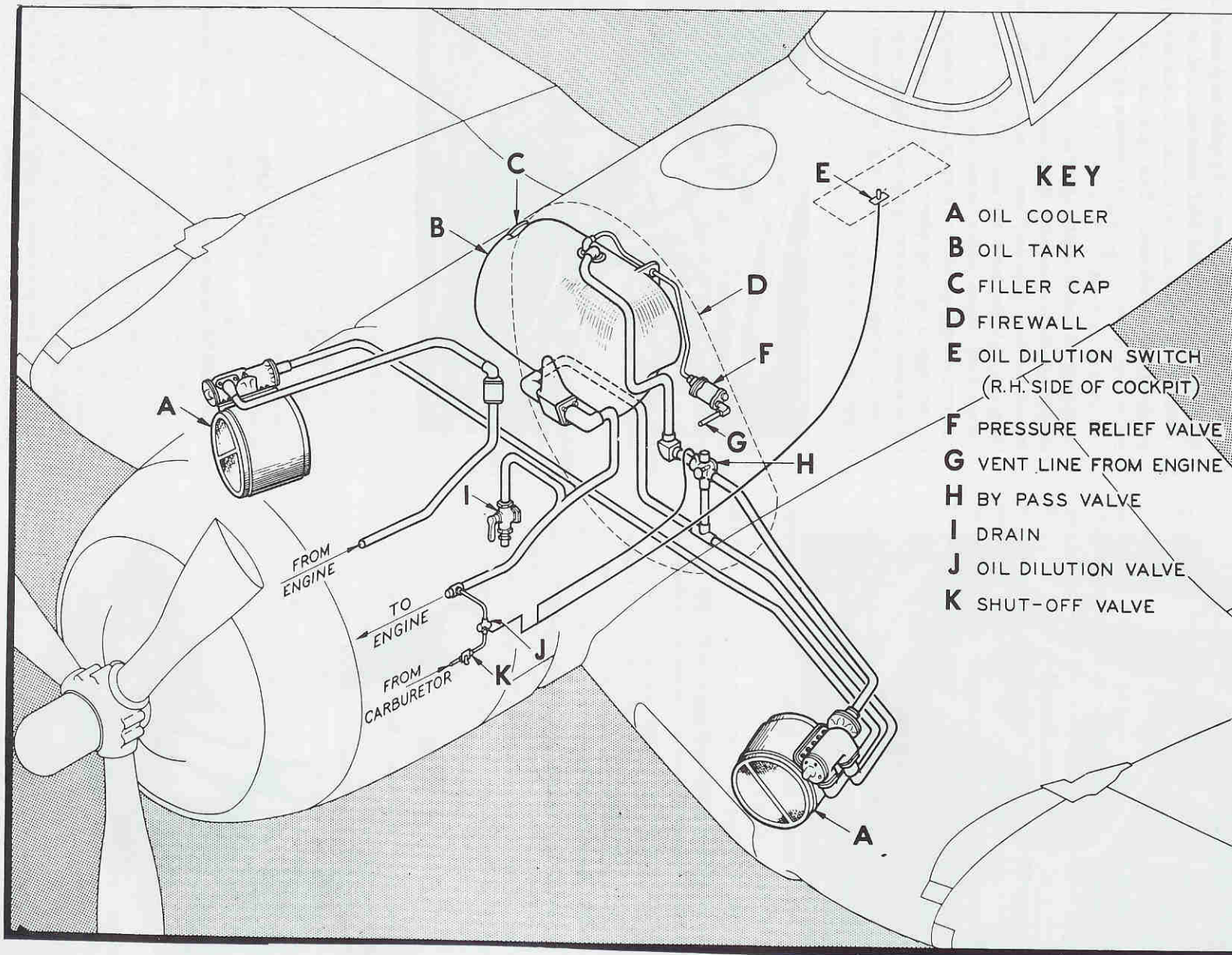

Fig. 12 — Oil System

## 7. HYDRAULICALLY OPERATED CONTROLS.

a. **HYDRAULIC OIL:** Specification: AN-VV-0-366a (or b).

b. **GENERAL.**—An engine-driven hydraulic pump, pressure regulator and accumulator combine to maintain a constant pressure of 925 to 1150 lbs./sq. in., indicated by the gage located on the right side panel in the cockpit. After a hydraulic control is moved, the pressure will drop and vary while the items are moving, and then become steady after the movement is completed. A hand pump is provided for use when the engine is not running or in event of failure of the engine-driven pump.

(1) The following items are operated by the airplane hydraulic system (refer to figures 20, 21, 22, 23, 24, 25, and 26):

(a) Cooling flaps (engine cowl, oil cooler, intercooler).

(b) Landing gear, landing gear doors and tail wheel.

(c) Wing flaps.

(d) Wing folding and locking.

(e) Arresting gear.

(f) Gun charging.

(g) Dive brake (main landing gear).

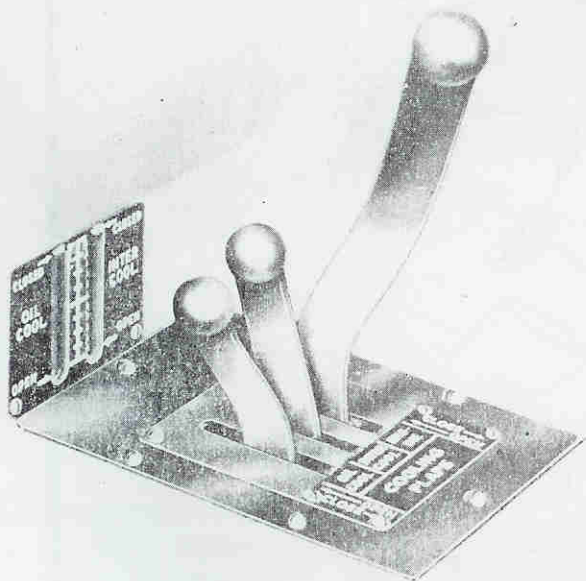

Fig. 13 — Cooling Flaps Controls and Indicators

(2) **COOLING FLAPS CONTROLS.**—The control levers for the cowl, oil cooler, and intercooler flaps are spring-loaded and must be held at either “OPEN” or “CLOSE” until the desired setting is obtained, then released. The positions of the oil cooler and intercooler flaps are shown by the respective indicators located just above the controls on the right side of the cockpit. A pressure relief valve is incorporated in the cowl flaps master cylinder to permit the cowl flaps to blow toward “OPEN,” while they are able to blow toward “CLOSE” against a spring load when under excessive air load. After having blown open they will not automatically return to the original setting when the speed decreases. A relief valve is incorporated on the “down” line to the oil cooler strut and on both “up” and “down” lines to the intercooler strut.

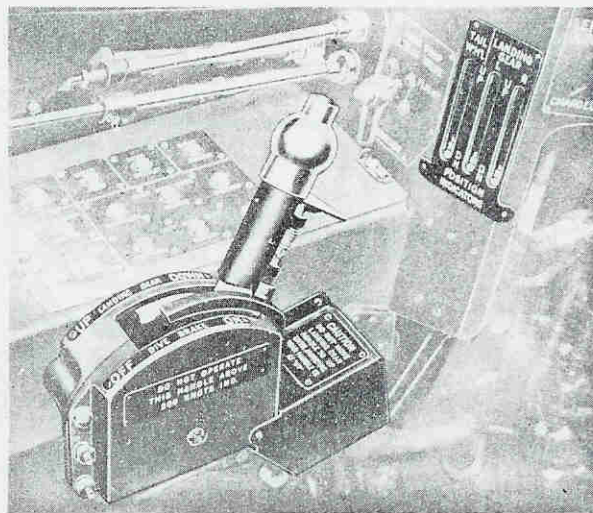

Fig. 14 — Landing Gear and Dive Brake Control

(3) **LANDING GEAR.**

### CAUTION

The landing gear control must be at “DOWN” at all times when the airplane is on the ground.

(a) To operate the landing gear (and tail wheel) retraction and extension, the control is moved to and locked in the desired position. The gear and the closure doors are automatically operated in proper sequence. The positions of each side of the landing gear and of the tail wheel are shown by the respective indicators.



### CAUTION

The tail wheel must not be extended by operating landing gear control to "DOWN" position in excess of 200 knots because serious damage to the tail wheel doors may result from the high air loads if the doors are open at high speeds.

### NOTE

A mechanical inter-lock is provided between the arresting gear control and the landing gear control. The arresting gear control cannot be moved to "DOWN" unless the landing gear control is set at "DOWN." Conversely, THE LANDING GEAR CONTROL CANNOT BE MOVED TO "UP" UNLESS THE ARRESTING GEAR CONTROL IS SET AT "UP." MOVE THE ARRESTING GEAR CONTROL FROM "PARKING" TO "UP" PRIOR TO TAKE-OFF.

(4) WING FLAPS. — The flap control mechanism, located above the pilot's left hand shelf, is designed so that any desired flap angle in 10° steps to "FULL DOWN" (50°) can be obtained by a corresponding setting of the wing flap control. The actual flap angle is shown by the indicator on the control unit.

(a) Due to the mechanical nature of the slide in the flap valve, the desired flap setting may not be obtained exactly when retracting the flaps from a greater to a lesser intermediate setting unless the flap control is moved slightly past the desired setting and then back to the position desired. The flaps on the right and left sides of the airplane are maintained "in step" by means of a hydraulic flow equalizer which functions only in the extension process. The flow equalizer does not operate when the flaps are moving "UP," that is, on retraction, or when the flaps are "blowing" up. It is possible that the hydraulic system on one side may be damaged (as by gunfire), so that the flap on that side would fail to extend, producing a rolling moment which would be difficult to balance by use of the ailerons with one flap fully extended. In this event, the pilot should be prepared to retract the flaps immediately if a rolling moment is noticed when the control is moved to extend them. Further, the landing flaps should normally be extended only at sufficient altitude so that corrective measures, if necessary, can be taken with confidence in their effectiveness.

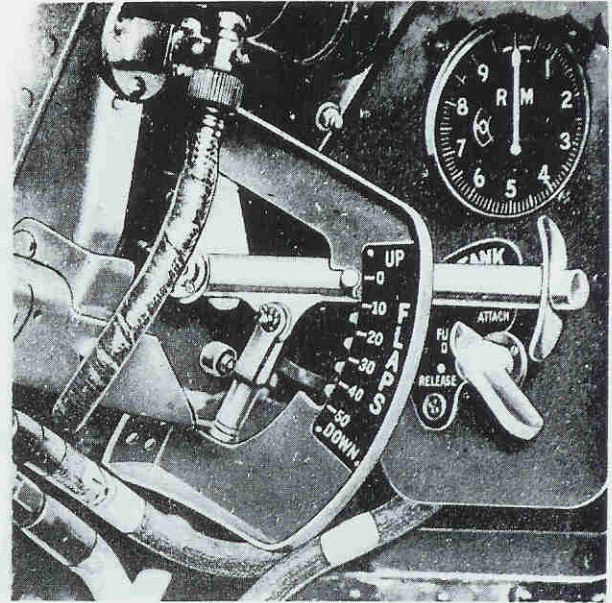

Fig. 15 — Wing Flap Control

(b) The wing flap system includes a mechanism which causes the flaps to "blow up" (back off) from the angle set by the control under excessive air loads caused by air speeds greater than normal. The flaps will return to the angle corresponding to the control setting when the air speed is reduced. The mechanism is set so that with flaps set full down (50°) and power on for level flight in the landing condition, they begin to "blow up" at between 90-110 knots, indicated. At lesser flap settings, the "blow-up" speeds will be greater than with flaps full down.

### NOTE

The landing (and maneuver) flap control shall not be placed in position for lowering flaps at speeds in excess of 200 knots even though the flaps are protected by an overload release mechanism. If the flap release mechanism is not in operation, the restricted speed with flaps open varies from 130 knots with flaps deflected 50° to 200 knots with flaps deflected 20°

(c) The flaps are also designed for use in maneuvering the airplane in combat. With typical maneuvering flap deflections of 20° or less (see Section II, paragraph 15. b.) the airplane may be maneuvered at equivalent limiting "flaps up" accelerations up to 200 knots.

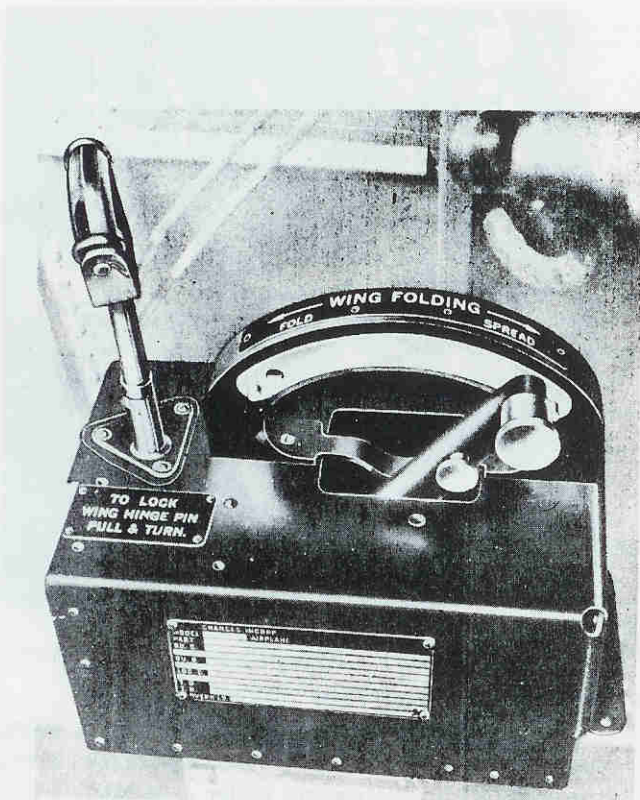

Fig. 16 — Wing Folding Control

(5) WING FOLDING. — To fold the wings, release the manual wing hinge pin lock handle, located down and aft to the left of the pilot. Then move the wing fold control (located to the left of the pilot) to "FOLD." This operation extracts the wing hinge pins and folds the wings in the proper sequence. With the engine running, the wings will fold automatically; otherwise, the hand pump must be used. To spread the wings, set the wing fold control to "SPREAD." This operation spreads the wings and inserts the hinge pins in proper sequence. When the wings are spread, lock the pins mechanically by pulling and engaging the manual wing hinge pin locking handle in the "LOCK" position.

(a) A visual check that the wings are fully spread and that the wing hinge pins are "home," is provided by the closing doors (painted RED inside) at the wing joints: These doors will not close until the outer panels are fully spread and the wing hinge pins "home." This check must be made by both the pilot and the ground crew.

## WARNING

WING FOLD HANDLE MUST ALWAYS BE IN "SPREAD" POSITION DURING FLIGHT.

(b) No provision is made in the wing folding part of the hydraulic system to keep the wings "in step" while being folded or unfolded; viz., no flow equalizer is installed. The wings must not be left free in any intermediate position between "FULLY SPREAD" and "FULLY FOLDED," as air loads will cause the wings to shift position, blowing one down and the other up. When fully folded, the wings should be locked by means of the jury struts provided. When the wings are fully folded and the jury struts installed, they may, by temporarily unlocking the jury struts, be moved to vertical for refueling and gun servicing by the action of the accumulator, if the pressure is up, or by the hand pump. The jury struts are telescopic, with a limit stop at the vertical position.

## NOTE

If the wing fold control is moved to "FOLD" before the manual wing hinge pin lock is released, damage will result. Thus, when starting to fold the wings, be sure that the manual wing hinge pin lock is released before the wing fold control is moved to "FOLD."

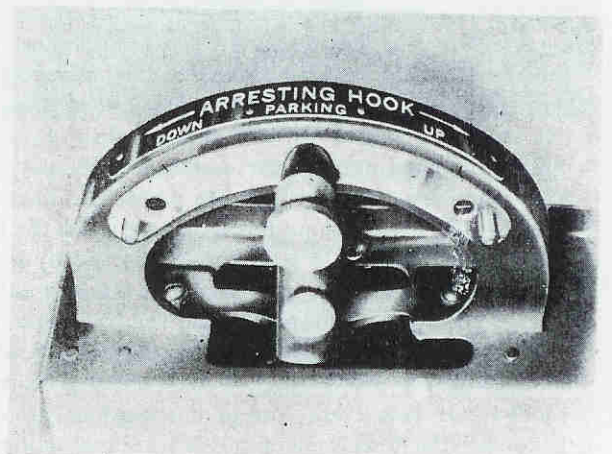

Fig. 17 — Arresting Gear Control

(6) ARRESTING GEAR. — Three settings for the arresting gear control, located on the right hand

panel, are provided; "UP," "DOWN," and "PARKING." To lower the hook (tail wheel extended) move the handle to "DOWN," and vice versa. At all times, except on arrested landings and when the airplane is on the ground, the hook control should be at "UP." Whenever the airplane is on the ground, the hook control should be set at "PARKING," thus isolating the hook hydraulic system and preventing the hook's dropping in the event of loss of hydraulic pressure.

#### NOTE

The arresting gear control must be set at "UP" prior to take-off. Otherwise, it will be impossible to retract the landing gear because of the mechanical interlock between the landing gear and arresting gear controls.

(7) GUN CHARGING. — The fixed guns are hydraulically charged. The top gun charging knob, located on the left hand side just below the main instrument panel, operates the charging and safetied of the three right guns while the lower knob controls the three left guns.

(a) To charge the guns, rotate the knob to "CHARGE," then push in. The knob will spring back out, indicating completion of the cycle of operation. The breeches are now closed, with live shells in the firing chambers. If the gun has been charged previously, one shell will be lost in this operation.

(b) To safety the guns, rotate the knob to "SAFE," then push in. The knob will spring back out when the guns are safe (breeches open). A new shell will be extracted from the ammunition belt and retained in the breech, and the existing shell, if any, in the breech will be ejected. To arm the guns, ready for firing after they have been safetied, simply rotate the knobs to "CHARGE." Pushing the knob in again would mean losing another shell.

#### NOTE

If the knob is stuck in, the gun will not fire.

(c) If for any reason it is suspected that the guns have not all been charged, better results can sometimes be obtained by holding the knob (pushed in) in the "CHARGE" position for several seconds. It should be noted that simply rotating the knob to "SAFE" does not safety the guns unless the knob is subsequently pushed in. No ammunition is lost in pushing the knob in while on "SAFE" position and,

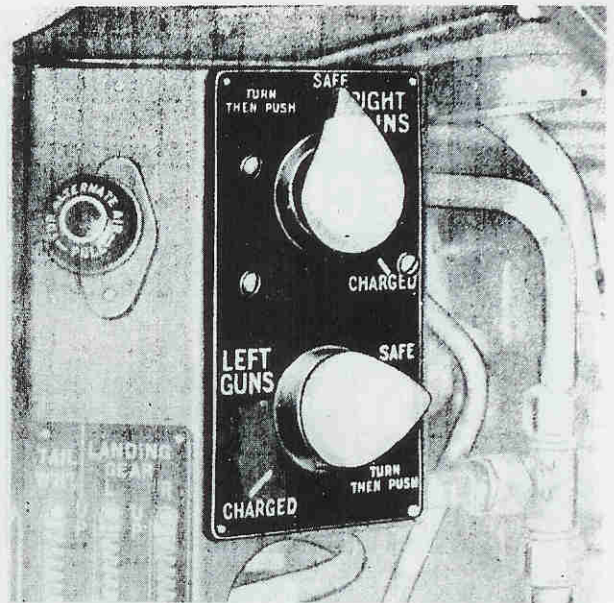

Fig. 18 — Gun Charging Control

hence, if in any doubt, no harm is done in pushing the knob in again for the pilot's own reassurance. The guns should always be safetied before landing.

(8) DIVE BRAKE CONTROL. — The shift-type dive brake control is located on the left side of the cockpit (see figure 14). Moving the control to "ON" extends the main landing gear only, the tail wheel remaining retracted. Moving the dive brake control to "OFF" retracts the main landing gear. It is not permissible to operate the dive brake control to extend the landing gear at more than 260 knots because at higher speeds the dive brakes will not extend fully or lock down. The dive brake control should not be operated to retract the landing gear above 350 knots.

#### WARNING

Do not dive the airplane with the tail wheel extended (landing gear control to "DOWN") as damage to the tail wheel doors, due to high air loads, may result.

(9) HAND PUMP CHECK VALVE. — This valve is located on the lower left hand auxiliary control panel, adjacent to the landing gear and tail wheel position indicators, and is provided for use in conjunction with the hand pump, but only when the airplane is on the ground and the engine is not running. When set to "GROUND" under these conditions, the

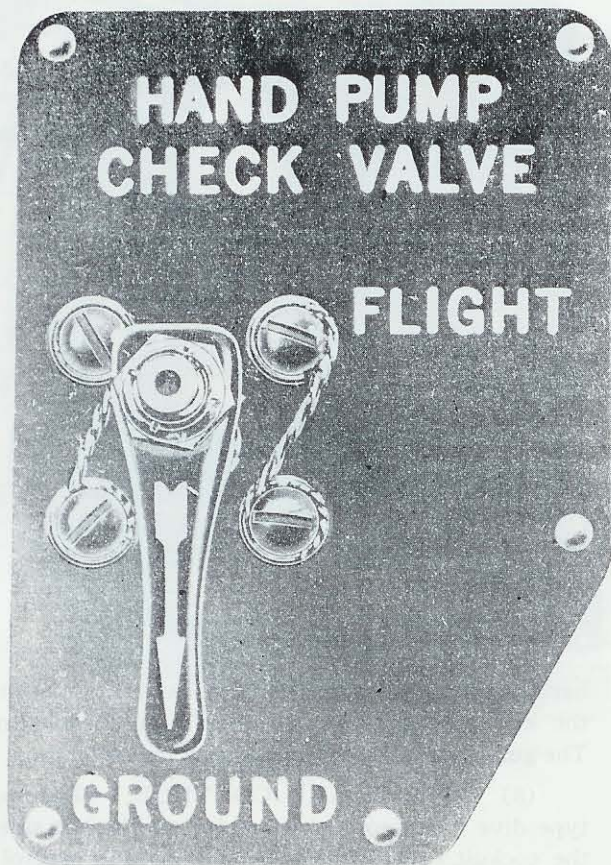

Fig. 19 — Hand Pump Check Valve

hand pump can be used to maintain the accumulator pressure. When set to "FLIGHT," as it should be for all operation except as noted above, the hand pump may be used to operate any unit of the hydraulic system (as in the event of failure of the engine-driven pump) without the necessity of pumping up the accumulator pressure. The pilot should assure himself before take-off that the check valve control is set to "FLIGHT."

(a) The feed for the hand pump is drawn from the bottom of the hydraulic reservoir, while that for the engine-driven pump is drawn from the  $\frac{1}{2}$  gallon level. In the event that failure of a hydraulic pressure line allows the engine-driven pump to pump overboard all of its available fluid, the  $\frac{1}{2}$  gallon of hydraulic oil remaining in the tank is sufficient for one operation each, by use of the hand pump (with manual check valve turned to "FLIGHT"), of the following: wing flaps, cooling flaps, and gun charging. The arresting hook does not require hydraulic pressure for extension. Emergency landing gear extension is provided for by the CO<sub>2</sub> extension system. See Section IV, paragraph 3.

#### NOTE

If it is known that the hydraulic system has lost fluid, the landing gear should be lowered by means of the emergency extension system, in order to conserve the remaining fluid for lowering flaps, etc.



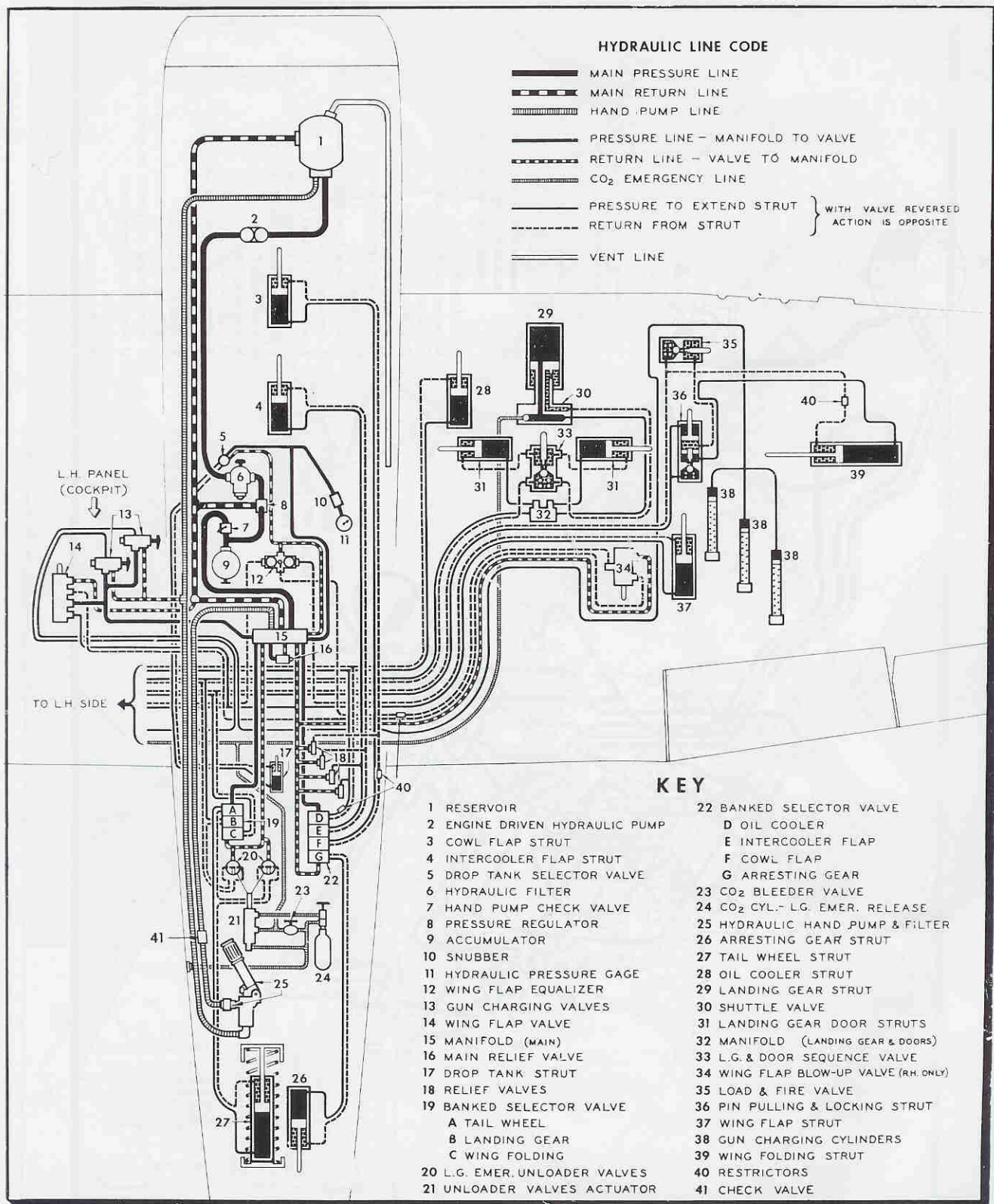

Fig. 20 — Hydraulic System Diagram

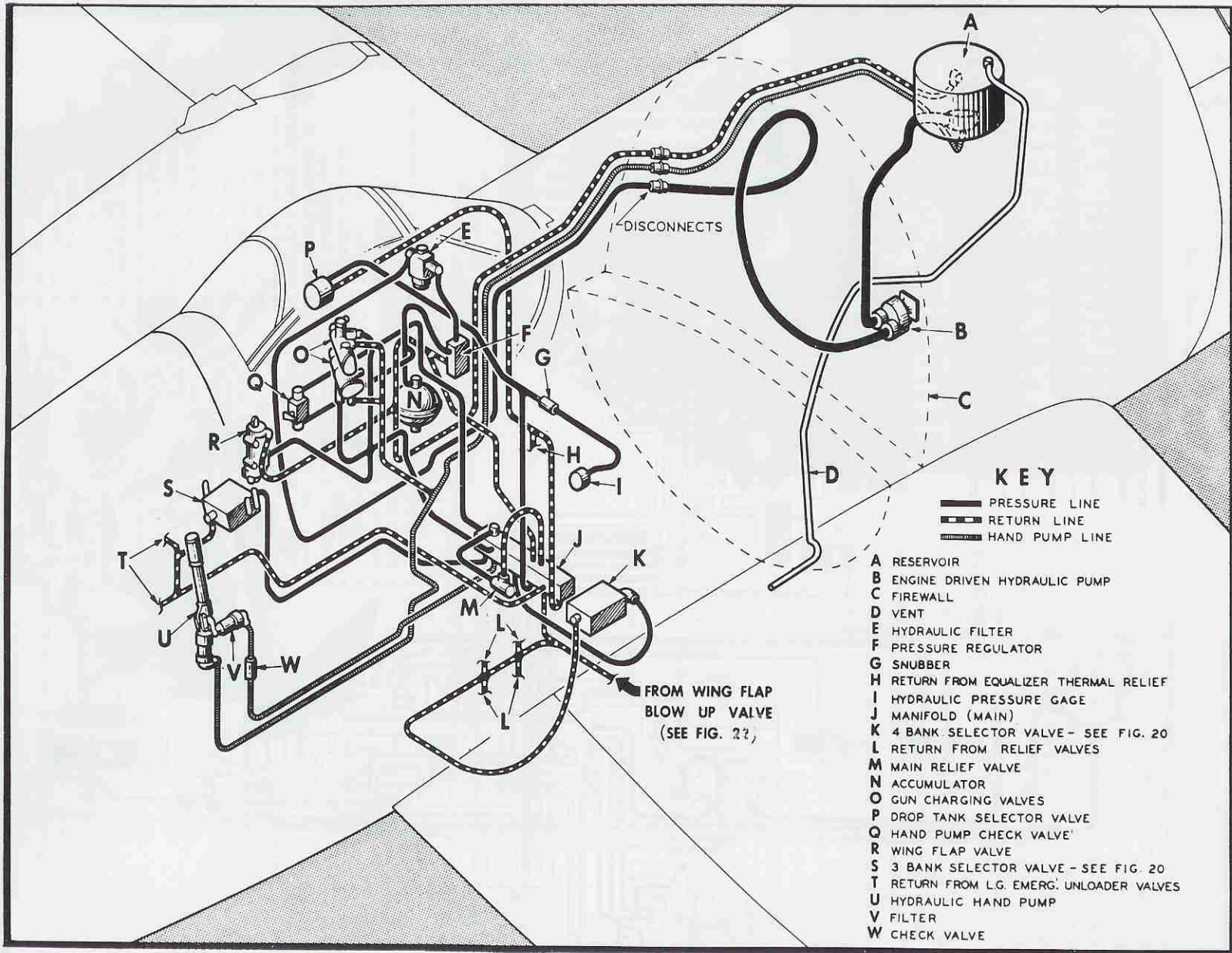

Fig. 21 — Hydraulic System Power Supply

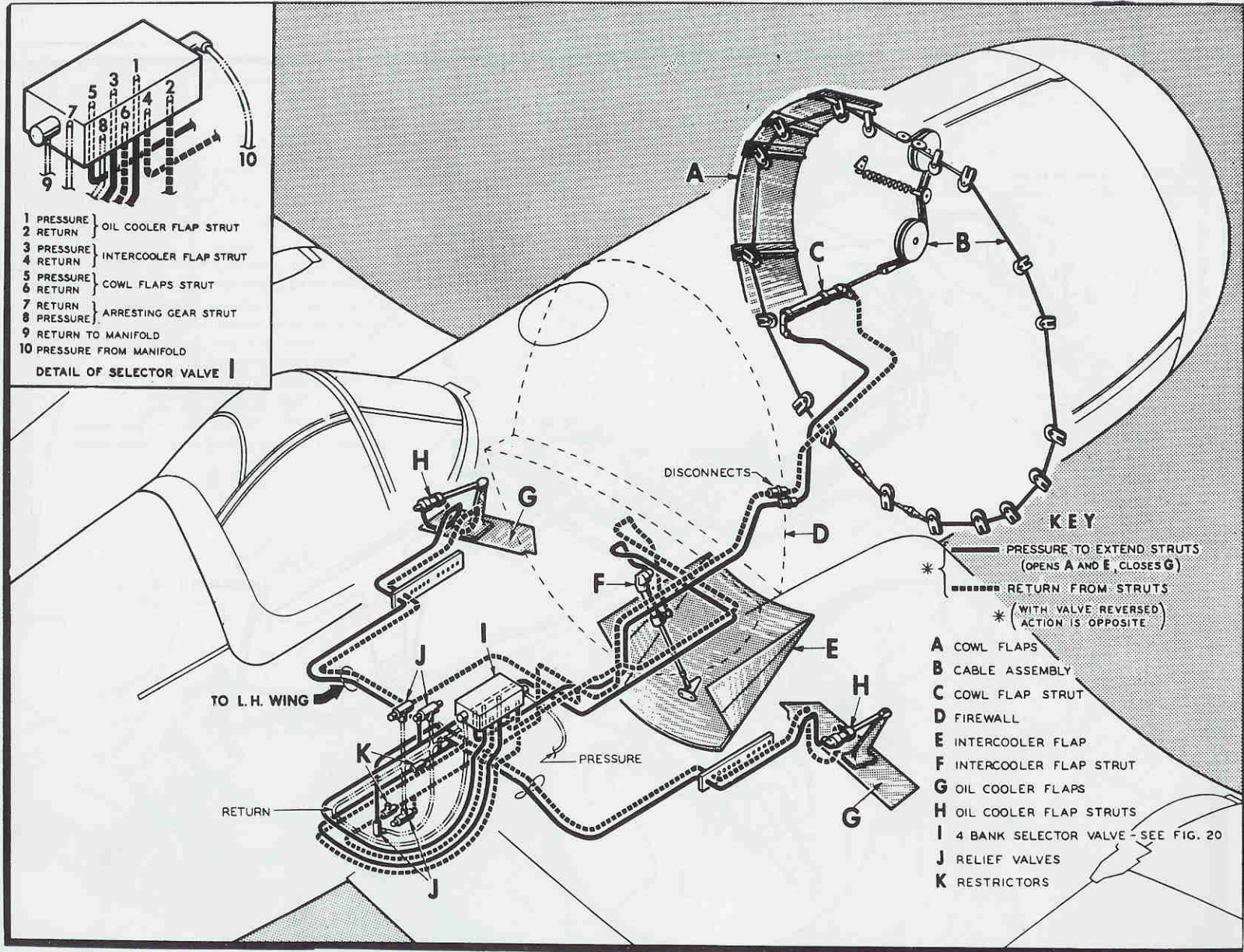

Fig. 22 — Cooling Flaps Hydraulic System

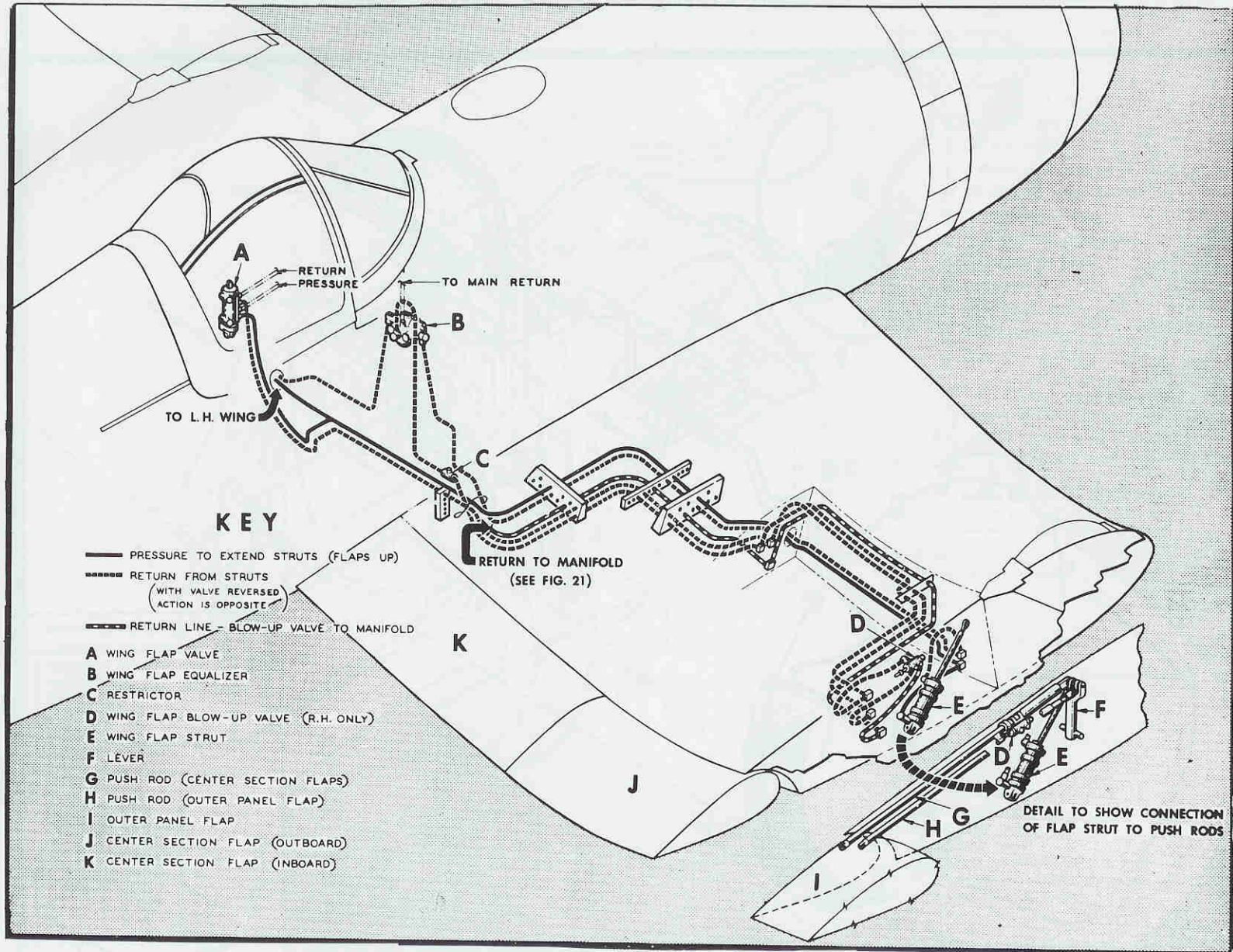

Fig. 23 — Wing Flaps Hydraulic System



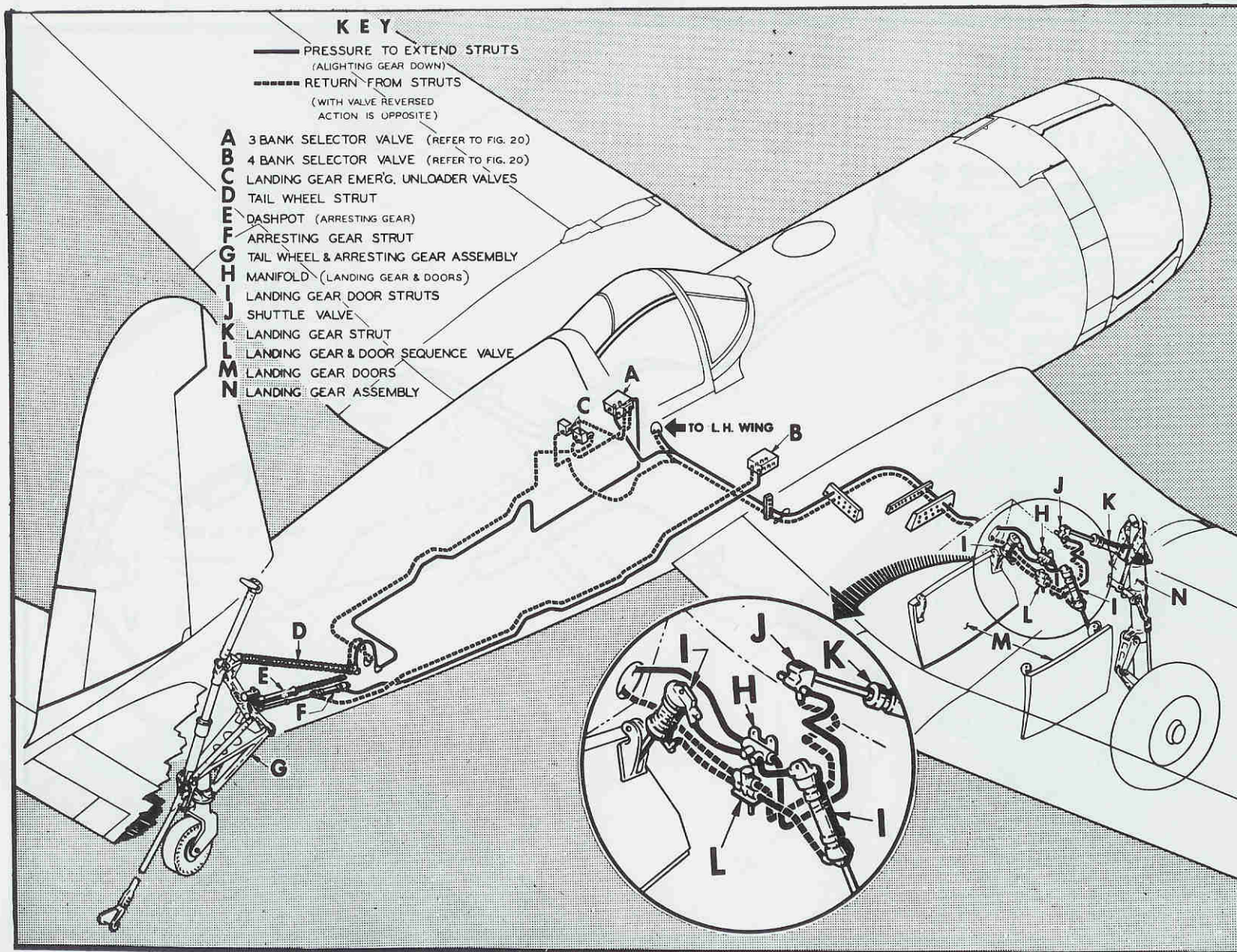

Fig. 24 — Alighting Gear Hydraulic System

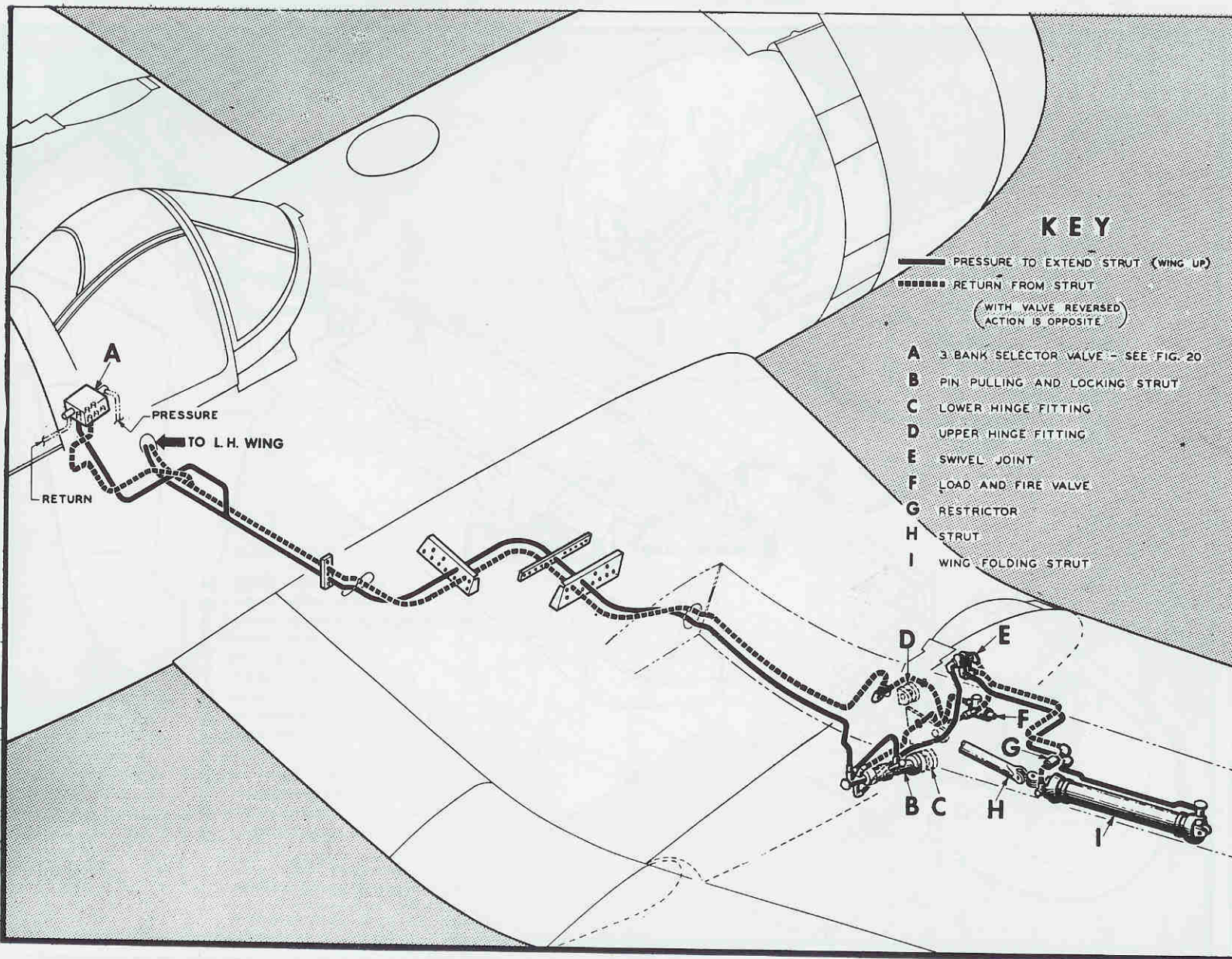

Fig. 25 — Wing Folding Hydraulic System

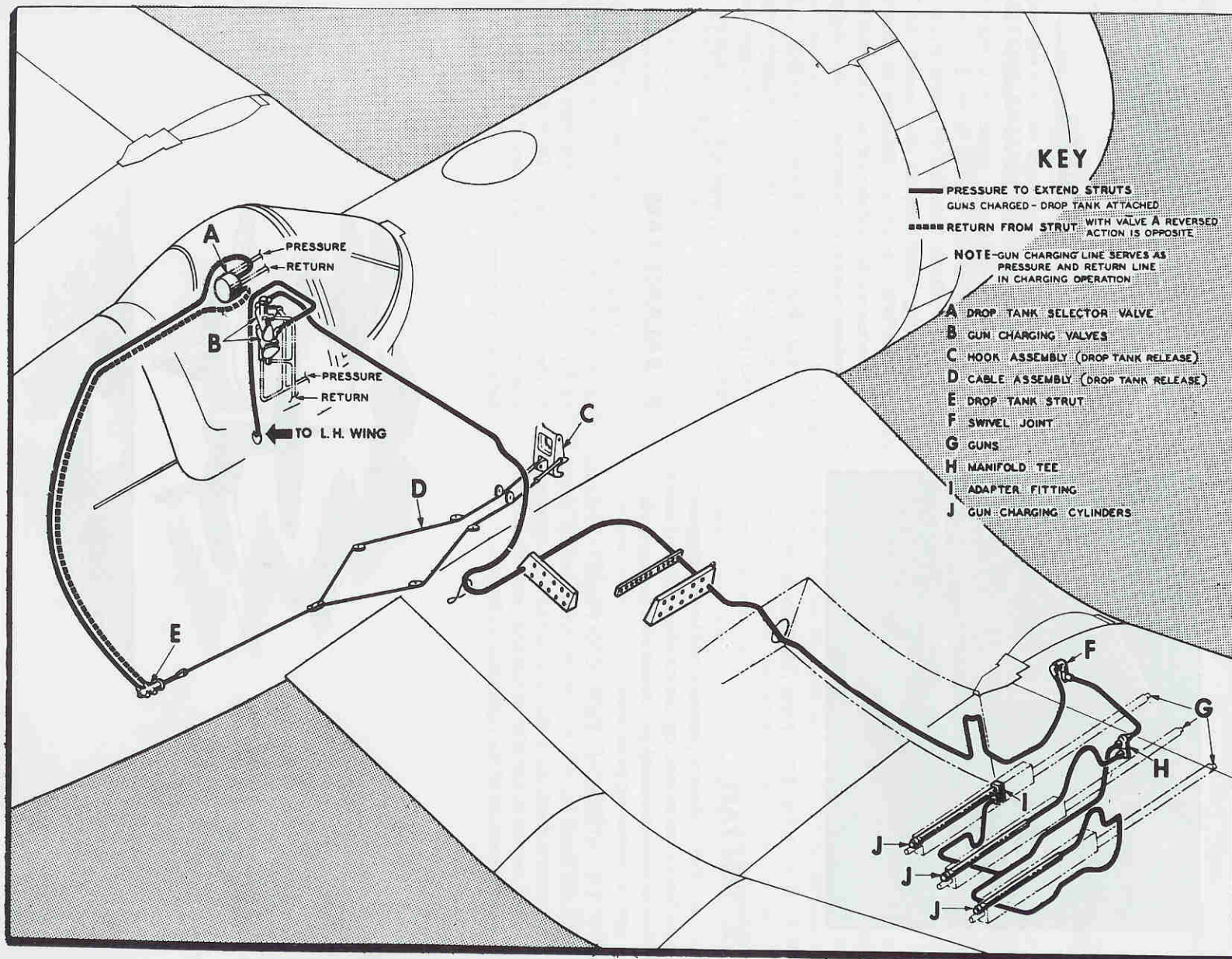

Fig. 26 — Gun Charging Hydraulic System and Center Line Drop Tank Hydraulic System

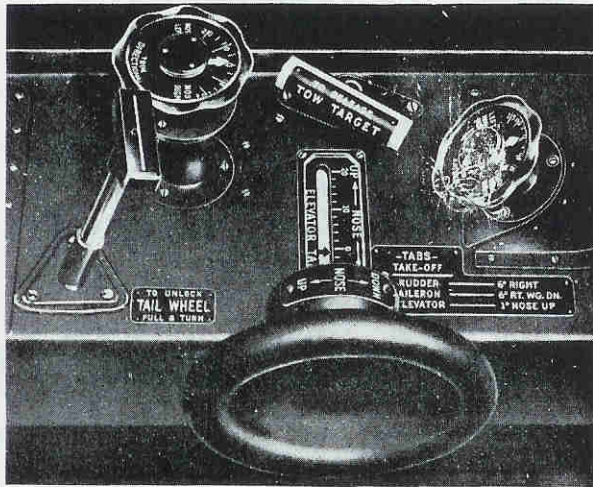

Fig. 27 — Trim Tab Controls

## 8. TRIM TABS.

a. Trim tabs are provided on the left wing aileron, on the elevators, and on the rudder to permit control forces to be trimmed to comfortable values under all normal operating conditions.

(1) **AILERON TAB CONTROL.**—Rotating the tab hand wheel (the inclined wheel on the pilot's left control shelf) clockwise, viz., to the right, transmits "UP" motion to the aileron tab and results in a downward movement of the right wing in flight.

(2) **ELEVATOR TAB CONTROL.**—Rotating the elevator trim tab control (large vertical wheel on the side of the left hand shelf) forward elevates the tabs which lowers the nose of the airplane in flight. Aft rotation lowers the tabs.

## CAUTION

In order to improve stick forces in the landing condition these airplanes are equipped with a heavy bungee spring, connected to the elevator controls and the tail wheel door mechanism, which becomes effective when the landing gear control is moved to the "DOWN" position. Because of this it is necessary to watch for a change of trim when raising or lowering the landing gear.

(3) **RUDDER TAB CONTROL.**—Rotating the rudder tab control (horizontal hand wheel on left hand shelf) clockwise, viz., to the right, moves the rudder tab to the left and results in moving the nose of the airplane to the right in flight.

## 9. BALANCE TABS.

a. Balance tabs are provided on ailerons and elevators in order to reduce the stick forces. These tabs require no control, since they are linked directly to the control surfaces. "DOWN" movement of the ailerons and elevators causes "UP" movement of the tabs, and vice versa.

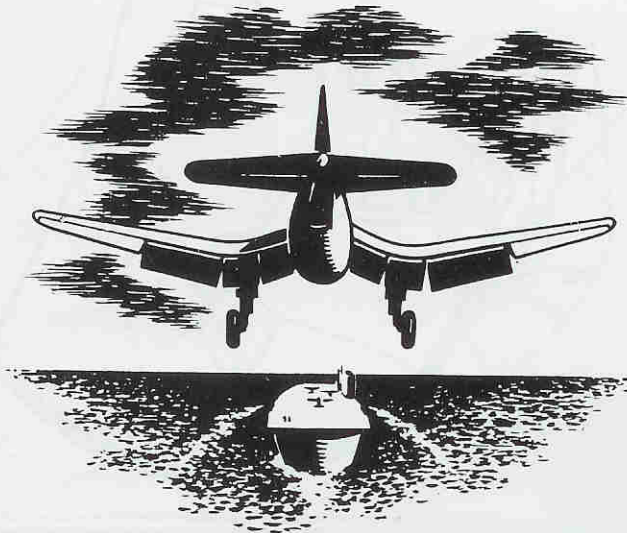



## 1. BEFORE ENTERING THE COCKPIT:

a. Obtain initial gross weight and loading data.

### (1) GROSS WEIGHT AND LOADING. —

It is not necessary to carry ballast to keep the center of gravity from being too far forward even though useful load items such as radio and armament are not installed. On the contrary, extra equipment of appreciable weight should not be carried, as the longitudinal stability, particularly in climb, will be adversely affected.

## 2. ACCESS TO COCKPIT.

a. Entrance to the cockpit is gained from the right side of the airplane. Steps, handgrips, and walkways are provided. The sliding section is controlled internally by a pull handle and externally by a push button (black button on upper forward end of sliding

section), either of which unlocks it from the cabin track, permitting it to be slid forward or aft.

## 3. FUEL SYSTEM MANAGEMENT.

a. In general, for high power operation at high altitude, use fuel from the main tank, which is pressurized to maintain adequate fuel flow. It is possible, on airplanes equipped with wing tanks in the outer panels (prior to installation of center section twin pylons), to operate under the above conditions while using fuel from the wing tanks if the auxiliary fuel pump is switched "ON"; under such conditions, keep a close watch on fuel pressure and cylinder head temperature. Some attention should be paid to the fuel quantities in the wing tanks to keep the fuel consumption in the tanks, approximately equal in order to maintain the airplane in approximate lateral balance, keeping the quantity in the right tank somewhat greater than that in the left tank, since the air-

plane has a tendency toward left wing heaviness in the landing condition with power on. Since no quantity gages are provided for the wing tanks, the quantities of fuel consumed must be determined from the time of operation on each tank.

**b. WATER INJECTION, SYSTEM.**—A water injection system for WAR EMERGENCY POWER operation is provided on airplanes bearing serial numbers 55910 F4U-1 (which includes British JT-331 and subsequent), 13992 FG-1, 11208 F3A-1 and subsequent. These airplanes can be readily identified by the green warning light on the upper right hand side of the main instrument panel (see figure 6). For further details concerning the use of the water injection system in obtaining war emergency power, refer to paragraph 14. *b.* and Section I, paragraph 1. *b.*

(1) **OPERATION.**—The throttle operates the switch which controls the water injection equipment. Moving the throttle control full forward (breaking the safety-wire stop) turns the water injection equipment "ON." When the throttle control is in any other position, the water injection equipment is "OFF." The throttle operated switch opens the solenoid shut-off valve in the water lines and starts the electric water pump. Water pressure acts on diaphragms to shut off a jet in the carburetor ("deriching" the mixture) and to reset the auxiliary stage supercharger regulator, permitting higher carburetor inlet pressure. Water is metered by a water regulator, which operates in the same manner as the metering unit in the carburetor, and is mixed with metered fuel just ahead of the fuel spinner discharge nozzle which is located in the face of the main stage supercharger impeller. Refer to figure 29.

(2) **WATER SUPPLY.**—The water supply is carried in three tanks, one of 5.9 U.S. gallon (4.9 Imp. gallon) capacity, one of 2.3 U.S. gallon (1.9 Imp. gallon) capacity, and one of 2.1 U.S. gallon (1.7 Imp. gallon) capacity; these are connected to a common supply line without individual shut-offs. The filler cap can be reached through a door at the top front of the accessory compartment. When three minutes water supply remains, a green warning light on the instrument panel flashes and stays "ON" as long as the throttle remains in the "FULL OPEN" position. Any water satisfactory for drinking purposes may be used. Water-alcohol mixtures must normally be used to prevent freezing in the system. Use of approximately 40 per cent by volume of ethyl alcohol, 2 U.S. gallons (1.7 Imp. gallons) of alcohol to 3 U.S. gallons (2.5 Imp. gallons) of water, will prevent freezing at  $-18^{\circ}\text{C}$ . ( $0^{\circ}\text{F}$ .).

#### 4. OIL PRESSURES AND TEMPERATURES.

*a.* The proper oil pressures and temperatures for the various operating conditions are given on the Operating Limits Charts, Section III.

*b.* The oil temperature can best be kept from exceeding the limit by:

- (1) Opening the oil cooler flaps.
- (2) Reducing engine rpm.
- (3) Increasing the climbing air speed.

#### NOTE

It will be observed that the oil pressure decreases slightly with altitude and takes an additional drop when shifting from "NEUTRAL" to "LOW" or "HIGH." This drop is normal and is to be expected. Oil pressure may drop as low as 70 lbs. per sq. in. at 25,000 feet at rated rpm, full throttle. Check operation of the Kenyon check valve in the oil breather return if oil pressure is lower.

#### 5. OIL DILUTION PROCEDURE.

*a.* In the event of low temperature forecast, viz. below  $-5^{\circ}\text{C}$ . ( $+23^{\circ}\text{F}$ .), the oil in the warm-up circuit shall be diluted in the following manner:

(1) Open the manual shut-off valve in the oil dilution line. This valve is located in the engine accessory compartment, just aft of the carburetor. Refer to figure 28.

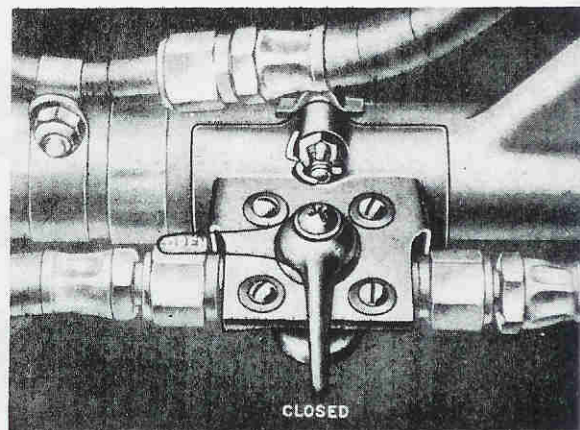

Fig. 28 — Oil Dilution Shut-off Valve

- (2) Start engine.
- (3) Engine oil inlet temperature between  $75^{\circ}\text{C}$ . ( $166^{\circ}\text{F}$ .) and  $85^{\circ}\text{C}$ . ( $185^{\circ}\text{F}$ .).

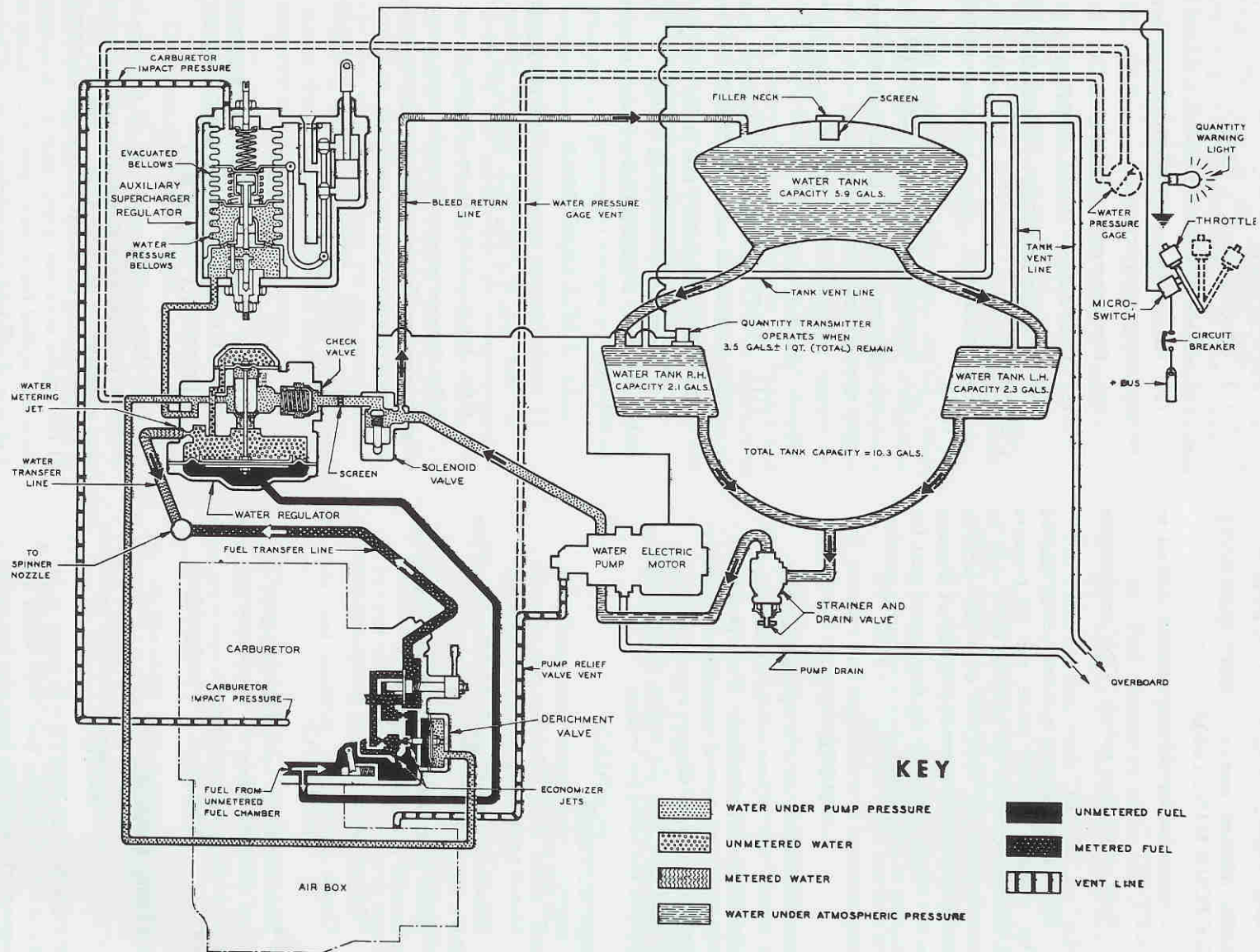

Fig. 29 — Water Injection System

(4) Engine speed constant — "1000 RPM."

(5) Oil dilution switch — "ON" (APPROXIMATELY FOUR MINUTES).

(6) Stop engine by moving mixture control to "IDLE CUT-OFF."

(7) Hold oil dilution switch "ON" until engine stops.

(8) When a cold engine is subsequently started and, after running a short while, the oil pressure starts to fluctuate or drop, the dilution valve shall be open intermittently for intervals of a few seconds over a period of about 15 seconds. If the oil pressure still does not steady out, stop the engine and wait for approximately five minutes before attempting another start.

### NOTE

When the dilution valve is opened (oil dilution switch "ON") there will be a sharp drop in indicated fuel pressure. Fuel pressure should return to normal immediately upon closing the valve (oil dilution switch "OFF"). If it does not, stop the engine immediately and check the valve for leakage.

#### b. PRECAUTIONS.

(1) Do not overdilute.

(2) Guard against fire.

(3) Dilute only when justified by forecast of low temperature, viz., below  $-5^{\circ}\text{C}$ . ( $+23^{\circ}\text{F}$ ).

(4) Allow adequate warm-up before taking off, except in cases of extreme emergency.

(5) Keep oil system free of sludge and water.

(6) Check position of dilution line shut-off valve.

(7) Since the oil in hydraulic propellers is not diluted, care must be taken to determine that the propeller pitch-changing mechanism is operating prior to take-off.

## 6. STARTING ENGINE.

### NOTE

FOR COMBAT FLIGHTS.—In order to fill water injection system line, hold water injection switch "ON" (by hand) for five to ten seconds, with the battery switch "ON," electric auxiliary fuel pump "OFF," before starting the engine.

#### a. PROCEDURE.

(1) Ignition switch — "OFF."

(2) Mixture control — "IDLE CUT-OFF."

(3) Rotate engine by hand — four or five revolutions in normal direction.

(4) Fuel selector — "RESERVE."

(5) Cowl flaps — "FULL OPEN."

(6) Propeller control — "TAKE-OFF RPM" ("DOWN").

(7) Carburetor air control — "DIRECT" ("IN").

(8) Supercharger control — "NEUTRAL."

(9) Starter — Insert cartridge, close breech, and lock; close access door and lock.

(10) Throttle — Set to red quadrant mark (approx. one inch open).

(11) Battery switch — "ON."

(12) Instrument switch — "ON."

(13) Electric auxiliary fuel pump — "ON."

(14) Electric primer switch — "ON" — five seconds (The time should be varied with temperature as indicated by service experience.)

(15) SIMULTANEOUSLY

Mixture control — "AUTO RICH."

Electric auxiliary fuel pump — "OFF."

(16) Ignition switch — on "BOTH."

(17) Starter switch — "ON." (Hold on until engine runs smoothly — booster coil or induction vibrator is connected to this switch.)

(18) Primer switch — "ON" intermittently until engine runs smoothly.

### CAUTION

DO NOT PUMP OR ABRUPTLY MOVE THE THROTTLE UNTIL THE ENGINE IS RUNNING SMOOTHLY.

(19) Idle — 1000 rpm — If oil pressure is not indicated in 30 seconds, stop engine and investigate.

#### b. FAILURE TO START ON FIRST ATTEMPT.

If the engine does not start, wait a few minutes to allow any spilled fuel to drain out of the intake ducts, and permit the cartridge starter to cool off before repeating the attempt. Inspection of the exhaust pipe outlets, especially those from the upper cylinders, should indicate whether the engine has been over or



under-primed. No trace of smoke indicates under-priming; excessive black smoke indicates over-priming. The use of the electric primer switch should be governed accordingly. If the engine is over-primed, clear the cylinders and induction system of the excess fuel as follows:

- (1) Mixture control — "IDLE CUT-OFF."
- (2) Electric auxiliary fuel pump — "OFF."
- (3) Ignition switch — "OFF."
- (4) Throttle — "FULL OPEN."
- (5) Rotate engine by hand — four or five revolutions in normal direction.

c. **GENERAL.**—Consistent starts will result from practice and experience. It is important, if backfires are to be prevented, that the procedure outlined above be used. It is strongly recommended that starting be practiced on an airplane from which the bottom accessory compartment cowl and carburetor air duct have been removed, to minimize the fire hazard and damage resulting from backfire. Do not attempt to adjust the idling of the engine when the carburetor air duct has been removed, since it will be affected by the changed air flow and temperature conditions.

### CAUTION

This airplane does not have a built-in CO<sub>2</sub> fire extinguisher. If the engine fails to start, leave the battery switch on for about 15 seconds so that indication of fire may be given by the carburetor air temperature warning light and extinguishing action can be taken before the rubber gasket on the carburetor air duct is damaged. If a fire is detected in the duct system, gain access to the fire with a CO<sub>2</sub> fire extinguisher, the nozzle of which should be pressed firmly against the air duct valve hole in the bottom accessory compartment cowl panel.

## 7. ENGINE WARM-UP AND ACCESSORY CHECK.

- a. Cowl flaps — "FULL OPEN."
- b. Oil cooler flaps — "CLOSED."
- c. Oil pressure — With cold oil, oil pressures may be above 200 lbs./sq. in. until oil-in temperature is approximately 40°C. (104°F.).
- d. Carburetor air control — "DIRECT" ("IN").
- e. Idle — 1000 rpm until oil temperature is 40°C.

(104°F.) and cylinder head temperature is 120°C. (248°F.).

f. Engine check — Open throttle to 2000 rpm, or at least 30 inches Hg.

- (1) Oil pressure 85-90 lbs./sq. in.
- (2) Fuel pressure 16-18 lbs./sq. in.
- (3) Magnetos — should not drop more than 100 rpm when shifting from "BOTH" to "RIGHT" or "LEFT."

g. Supercharger check run at 1200-1400 rpm (propeller control — take-off rpm).

- (1) Oil temperature 60°C. (140°F.) minimum.
- (2) Oil pressure 50 lbs./sq. in.
- (3) Shift to "HIGH." (A momentary drop in oil pressure and fluctuation of manifold pressure and rpm should accompany the shift.)
- (4) Open throttle to approximately 30 inches Hg.
- (5) Observe manifold pressure and oil pressure when rpm is stabilized.
- (6) Shift to "LOW." (Fluctuation of manifold and oil pressure should accompany the shift.)

### CAUTION

Backfiring may result from opening the throttle too suddenly from idling position (in flight or on the ground).

### CAUTION

Do not idle below 800 rpm any longer than is necessary, to avoid fouling plugs. Be sure to clear out engine and check both magnetos before take-off after protracted idling.

### CAUTION

Do not exceed 232°C. (450°F.) cylinder head temperatures before "TAKE-OFF."

## 8. EMERGENCY TAKE-OFF.

a. In the event that emergency take-off is necessary, the following sequence of operations must be performed before the engine can be properly warmed up:

- b. Propeller control — "MAX. RPM" ("DOWN").
- c. Manifold pressure — 35 to 40 inches Hg.
- d. Cooling flaps — "CLOSED."

## NOTE

In case of a short field or runway, lower flaps "FULL DOWN," make a normal take-off run, and take off with nose high.

## WARNING

THE ABOVE PROCEDURE IS VERY HARMFUL TO THE ENGINE. USE ONLY IF ABSOLUTELY NECESSARY.

## 9. TAXIING INSTRUCTIONS.

a. Use the S-turn procedure for adequate forward vision on taxi strips. However, let the airplane roll freely where possible, using the brakes as an aid in steering, stopping, and holding.

b. Use the tail wheel lock in extended cross-wind taxiing to relieve excessive braking action.

c. Use low power when taxiing. Don't rev-up the engine and then ride the brakes. Bear in mind that badly overheated brakes are not fully effective and can fuse the brake discs to the extent of leaving them frozen for landing.

## 10. STANDARD CHECK FOR ALL FLIGHTS.

### a. CHECK LIST:

- (1) Fuel quantity aboard.
- (2) Power plant ground test.
- (3) Generator output.
- (4) Radio operation.
- (5) Stick and rudder free.
- (6) Rudder, brake pedal, and seat height adjusted.
- (7) Shoulder harness — "LOCKED."
- (8) Wings — "SPREAD" and "LOCKED."

## NOTE

Check to see that wing fold control is in "SPREAD" position, that closure doors at wing joints are closed, and mechanical wing hinge pin locking handle is in the "LOCK" position.

- (9) Arresting hook control — "UP."
- (10) Fuel tank selector — "RESERVE."
- (11) Mixture — "AUTOMATIC RICH."
- (12) Supercharger control. — "NEUTRAL."
- (13) Propeller control — "MAX. RPM" ("DOWN").

(14) Cowl flaps — "2/3 OPEN."

(15) Intercooler flap — "CLOSED."

(16) Oil cooler flap — "OPEN" as required.

(17) Alternate air control — "DIRECT" ("IN").

(18) Rudder tab — "6° NOSE RIGHT."

(19) Aileron tab — "6° RIGHT WING DOWN."

(20) Elevator tab — "1° NOSE UP."

(21) Wing flaps — set as required. See paragraph c. below.

(22) Tail wheel — "LOCKED."

(23) Check that safety pins in cabin release handles (painted RED) are properly in place.

(24) Manifold pressure limit — 54.0 inches Hg.

(25) Check magnetos and cylinder head and oil temperatures.

(26) Open the throttle gradually and smoothly.

b. **TAB SETTINGS.** — Due to the high engine power and low propeller gear ratio, the proper tab settings must be used for take-off; otherwise, needless difficulty will be encountered. The rudder force required to maintain a straight run will be high unless the rudder tab has been set at approximately "6° NOSE RIGHT" prior to the start. Also, the left wing tends to be slightly heavy just as the airplane becomes airborne, due to high torque reaction. If the aileron tab is set approximately "6° RIGHT WING DOWN" before the start, and, if the airplane is not lifted off prematurely, this effect can be avoided. Use of the proper tab settings is particularly important when high flap settings and maximum power are used. Individual airplanes will require slightly different tab settings from those given above. It may be noticed that the tab control knobs rotate slightly when the stick and rudder controls are moved. However, the actual tab setting does not change.

c. **FLAP SETTINGS.** — For normal operation it is recommended that a setting of 20° be used for take-off. Actually, any flap setting from 0° to 50° may be used, the higher settings giving shorter ground distance. Take-offs with flaps up are easily accomplished with a small increase in run, dispensing with the inconvenience of retracting the flaps after take-off. In addition, the rate of climb immediately after take-off with flaps deflected is in-

ferior to that with flaps "UP." Take-offs at high flap settings and at full flap should be made only when it is necessary to obtain the shortest possible ground run, and after more experience with settings increased gradually from the recommended setting of 20°. When a high flap setting is used, the elevator tab should be set slightly more tail heavy (about 1°).

**NOTE**

It has been found that with the flaps down, the tail cannot be held on the ground, with the stick full back, at manifold pressures greater than 44 inches Hg. Also, when operating from a wooden platform, the wheels will start slipping on the deck at approximately the same manifold pressure. As a result, when making carrier take-off it is necessary to advance the throttle through the final portion of its travel as the airplane starts to roll. No difficulty should be encountered in this operation.

**11. ENGINE FAILURE DURING TAKE-OFF.**

a. In the event of engine failure during take-off, as many as possible of the operations listed below shall be performed in the order given:

- (1) Landing gear — "UP," unless sufficient runway is available STRAIGHT AHEAD for a landing in the normal (wheels down) landing condition.
- (2) Switches (battery, generator, ignition) — "OFF."
- (3) Flaps — "DOWN."
- (4) Fuel selector — "OFF."
- (5) Mixture control — "IDLE CUT-OFF."

**NOTE**

The battery switch turns off the electric auxiliary fuel pump.

**12. AFTER TAKE-OFF.**

a. CHECK-OFF LIST:

- (1) Reduce manifold pressure to not over 44.0 inches Hg.
- (2) Reduce rpm to not over 2550
- (3) Retract landing gear.
- (4) Retract wing flaps.

(5) Trim airplane for 125 knots indicated air speed for best climb.

(6) Adjust cowl flaps, if necessary.

(7) Adjust oil cooler flaps, if necessary.

(8) Set fuel tank selector to desired setting.

b. Unless a rapid rate of climb is desired, it is recommended that the manifold pressure and rpm be further reduced to 34 inches Hg. and 2300 rpm, and the air speed increased to 10 knots above the normal air speed for climb.

**CAUTION**

Do not retract the flaps too soon or too rapidly after take-off if the speed is very low; otherwise, the airplane may settle due to the loss in lift. It should be remembered that the higher the take-off speed, the better the control.

**13. CLIMB AND LEVEL FLIGHT.**

a. MILITARY POWER CLIMB AND LEVEL FLIGHT — 2700 RPM.—Operate according to the Specific Engine Flight Chart and the Operating Limits Charts in Section III. Table I gives the throttle and supercharger control settings for this condition.

**CAUTION**

Do not exceed 260° C. (500°F.) cylinder head temperature.

**TABLE I**

ALTITUDE	MAN. PRESS. IN. HG.	BLOWER
S.L.-1700 1700-5500	52.5* F.T. (SHIFT TO "LOW" WHEN MAN. PRESS. DROPS TO 45.0 IN.)	"NEUTRAL"
5500-16000 16000-18000	53.0 (F.T.) F.T. (SHIFT TO "HIGH" WHEN MAN. PRESS. DROPS TO 50.0 IN.)	"LOW"
18000-21000	53.0*	"HIGH"

\*The altitudes at which these manifold pressures can be obtained vary considerably with carburetor entrance conditions. The above values are for standard air and no ram (refer to definition of "ram" in Appendix II). At high speed the above manifold pressures will be reached at higher altitudes.

**CAUTION**

Reduce manifold pressure three to four inches Hg. to avoid power surge when shifting.

b. **RATED POWER CLIMB AND LEVEL FLIGHT** — 2550 RPM.—Operate according to the Specific Engine Flight Chart and the Operating Limits Charts in Section III. Table II gives the throttle and supercharger control settings for this condition.

### CAUTION

Do not exceed 260°C. (500°F.) cylinder head temperature.

**TABLE II**

ALTITUDE	MAN. PRESS. IN. HG.	BLOWER
S.L.-5500 5500-7000	44.0* F.T. (SHIFT TO "LOW" WHEN MAN. PRESS. DROPS TO 41.5 IN.)	"NEUTRAL"
7000-16500 16500-18000	49.5* F.T. (SHIFT TO "HIGH" WHEN MAN. PRESS. DROPS TO 47.0 IN.)	"LOW"
18000-22000	49.5*	"HIGH"

\*The altitudes at which these manifold pressures can be obtained may vary considerably with carburetor entrance conditions. The above values are for standard air and no ram (refer to definition of "ram" in Appendix II).

## 14. GENERAL FLYING CHARACTERISTICS.

a. Refer to the Specific Engine Flight Chart in Section III, the discussion on Gross Weight and Balance, this section, paragraph 1., and the discussion on Supercharger Control in Section 1, paragraph 3. a. (4).

b. **WAR EMERGENCY POWER** — 2700 RPM (FIVE MINUTES).

- (1) To obtain war emergency power:
  - (a) Mixture control — "AUTO RICH."
  - (b) Propeller control — "2700 RPM."
  - (c) Throttle — "FULL OPEN."

(2) War emergency ratings are based upon engine structural limitations, water injection being used to suppress detonation; **THESE RATINGS ARE FOR COMBAT USE ONLY.**

(3) When in "LOW" or "HIGH" blower the supercharger regulator resets to normal when the water supply is exhausted; "WHEN IN NEUTRAL BLOWER, BELOW 3000 FEET, THE THROTTLE MUST BE RETARDED TO PREVENT OVER-BOOSTING WHEN THE WATER SUPPLY IS EXHAUSTED."

### WARNING

**THE WATER INJECTION EQUIPMENT WILL BE OPERATED WHENEVER THE THROTTLE IS IN THE "FULL OPEN" POSITION. WHEN WATER INJECTION IS NOT DESIRED, THE LAST 3/8 INCH OF THROTTLE MOVEMENT MUST NOT BE USED.**

### NOTE

Holes for a safety-wire stop have been provided in the throttle quadrant to prevent inadvertent use of water injection. Since use of the water injection system necessitates breakage of the stop, a new safety-wire should be installed before next flight, making sure that the wire is installed correctly and is of the proper gage.

c. **CRUISING.**—The engine should be operated in "AUTO LEAN" for cruising power operation, as shown on the Operating Limits Charts, Section III. If a cylinder temperature of 232°C. (450°F.) is exceeded, the mixture should be enriched. The cruising manifold pressure-rpm relationships specified in the Operating Limits Charts should not be exceeded.

(1) **MAXIMUM.**—While cruising operations may be conducted at any engine power below normal rated power, if minimum fuel consumption is of importance and if it is tactically feasible to do so, cruising operation should be conducted in a range not to exceed 65 per cent of normal rated power.

(2) **RECOMMENDED.**—Most efficient cruising operation will be obtained at power considerably below maximum cruising.

### NOTE

Operation at approximately 150 knots indicated air speed at 1300 rpm, "NEUTRAL" blower, will result in near best range operation (approximately 42 gallons per hour).

### CAUTION

When operating below 1400 rpm, reduce electrical load as much as possible to prevent battery discharge.

(3) **VIBRATION.**—Operation is smooth except at 2200 rpm at 30 to 35 inches Hg., and between 1750 and 1950 rpm. Though operation in these ranges is not dangerous, it is objectionable and should be avoided, if possible.

### CAUTION

Avoid operation at high rpm with small throttle opening in either "LOW" or "HIGH" blower; power pulsations, surging, and excessive carburetor air temperature are likely to result.

#### d. MAXIMUM PERMISSIBLE INDICATED AIR SPEED AND ACCELERATIONS.

(1) The maximum permissible speeds and accelerations at various altitudes are shown on the graph below for a gross weight of 12,000 pounds. At other weights the permissible accelerations are such as to maintain a constant product of gross weight and acceleration except that 7.5g positive and 3.5g negative should not be exceeded. The limit of the actual

accelerations and speeds that can be withstood with safety is indicated by a general buffeting or shaking. It is dangerous to continue increasing acceleration or speed once the buffet begins because the shaking and vibration increase the loads in the tail structure and so may cause damage to the stabilizer and elevator; therefore, when buffeting is encountered, immediately reduce speed or acceleration or both. In general, this phenomenon occurs at lower indicated speeds at the higher altitudes as seen on the graph below.

### WARNING

Pilots should avoid steep dive angles because of the difficulty encountered in attempting to reduce speed and acceleration quickly if buffeting should occur.

### NOTE

This illustration will be furnished at a later date.

*Operating Flight Strength Diagram*

## 19. DIVING:

### a. CHECK-OFF LIST:

- (1) Cabin — "CLOSED."
- (2) Landing gear control — "UP."
- (3) Dive brake control — "OFF" or "ON" as desired.
- (4) Wing flaps — "UP."
- (5) Propeller control — Set at 2400 rpm or lower.
- (6) Mixture — "AUTOMATIC RICH."
- (7) Throttle — "SLIGHTLY OPEN"
- (8) Supercharger — "NEUTRAL"
- (9) Fuel tank selector — "RESERVE."
- (10) Cowl flaps — "CLOSED."
- (11) Oil cooler flaps — "CLOSED."
- (12) Intercooler flaps — "CLOSED."
- (13) MAXIMUM RPM LIMIT — 3060 RPM (NOT OVER 30 SECOND DURATION). ALL DIVING SHALL BE DONE IN "NEUTRAL" BLOWER.

b. COCKPIT CABIN. — The cockpit cabin sliding section must be closed before entering high speed dives, as it is not designed for such speeds in the open position. In the open position, speeds up to 300 knots indicated are allowable.

c. DIVE BRAKE CONTROL. — The dive brake will not extend and lock down at speeds greater than 260 knots and should not be retracted at speeds in excess of 350 knots.

### d. SPEED AND ACCELERATION LIMITS.

(1) GENERAL. — The speed and acceleration limits of the airplane have been defined in paragraph 14. d. (1) of this section.

### WARNING

TESTS TO DATE INDICATE THAT THE AIRPLANE, IF PERMITTED, WILL ATTAIN MUCH HIGHER THAN THE LIMIT SPEEDS. PILOTS SHOULD GAIN FAMILIARITY WITH THE DIVING CHARACTERISTICS OF THE AIRPLANE GRADUALLY, WHILE MAINTAINING ABSOLUTE CONTROL OVER THE DIVING SPEED. THE SPEED LIMITS SHOULD BE FIRST AP-

PROACHED ONLY AFTER SUCH FAMILIARIZATION, AND IN DIVES AT MODERATE ANGLES. FAMILIARITY WITH THE LIMITATIONS IMPOSED BY THE SHAKE DISTURBANCE ON PULL-OUT SHOULD ALSO BE GRADUALLY ACQUIRED.

(2) CENTERLINE DROP TANK. — Because of the limited strength of the centerline drop tank the following restrictions shall not be exceeded when the full tank is carried:

Positive acceleration — 5g.

Negative acceleration — same as airplane with appropriate gross weight.

Maximum speed — 375 knots.

(3) CENTERLINE 1000 POUND BOMB. — When carrying a 1000 pound bomb on the centerline the normal airplane restrictions apply except that 5g positive shall not be exceeded.

(4) TWIN PYLON BOMBS AND DROP TANKS. — When carrying bombs or drop tanks on the twin pylons, the normal airplane restrictions apply.

## 20. APPROACH AND LANDING.

### a. CHECK-OFF LIST.

- (1) Shoulder harness — "LOCKED."
- (2) Tail wheel — "LOCKED" (for field).  
"FREE" (for carrier).
- (3) Fuel tank selector — "RESERVE."
- (4) Mixture — "AUTOMATIC RICH."
- (5) Supercharger control — "NEUTRAL."
- (6) Propeller control — 2300 rpm to 2400 rpm.
- (7) Cowl flaps — "CLOSED."
- (8) Alternate air control — "DIRECT" ("IN").
- (9) Landing gear — "DOWN."
- (10) Wing flaps — Set 30°, or as required, for field landing.  
50° for carrier.
- (11) Arresting hook — "UP" for field.  
"DOWN" for carrier.
- (12) Gun switches — "OFF."
- (13) Gun charging knobs — "SAFE" (push in).

b. **LANDING LIGHT.**—The landing light switch is located on the right hand panel in the cockpit.

#### **NOTE**

No landing lights are installed on airplanes bearing serial numbers 17930 F4U-1 (which includes British JT-331 and subsequent), 13261 FG-1, 04592 F3A-1 and subsequent.

c. **RECOMMENDED SEQUENCE.**

- (1) Extend landing gear at a speed less than 200 knots.
- (2) Open cabin.
- (3) Lower flaps to desired setting.
- (4) Observe items on check-off list.
- (5) Air speed in approach — 90 to 95 knots.

#### **WARNING**

Pilots should avoid flat approaches. Immediately after flaring out, no difficulty should be experienced in executing a normal three-point attitude landing.

d. **FLAP SETTING.**—For field landings, it is recommended that a setting of 30° be used until the pilot is familiar with the airplane. Lesser flap settings will result in increased ground run. Flaps “FULL DOWN” shall be used for carrier landings. Flaps “FULL DOWN” may be used for field landings, when a short run is desired, after experience with the airplane has been obtained.

e. **FORCED LANDING.**—In the event of a forced landing with no power, it will be found, in general, that hitting a given spot will be easier if the airplane is glided in the initial approach, with reduced flap settings and at a slightly higher speed than that used for a normal approach. This will insure a better gliding ratio and better stability and control. Due to the fact that the airplane is heavily flapped, it will be found that by lowering the flaps to “FULL DOWN” the glide path can be considerably steepened without picking up excessive speed, and that the airplane will decelerate rapidly to minimum flying speed after flaring out. This is a considerable advantage in making forced landings, since the approach can be made high and with ample speed. Once the pilot is certain of reaching the intended landing area, application of full flap permits a steepened glide path, thereby increasing the accuracy of the approach. In the event of power failure, the pilot should check hydraulic accumulator pressure while descending

(turning the manual check valve to “GROUND” and bringing the pressure up with the hand pump, if necessary, so that ample pressure will be available to lower the flaps rapidly).

#### **NOTE**

The best gliding speed to obtain maximum range, power off, clean condition, is 140 knots indicated. In the event of engine failure, it is important that the airplane be glided at this speed, particularly if there is the least doubt that sufficient altitude is available to reach the point of intended landing.

#### **NOTE**

**THE LANDING GEAR SHALL BE “UP” FOR ALL FORCED LANDINGS.** Refer to Section IV, paragraph 4.

f. **CROSS-WIND LANDINGS.**—Cross-wind landings can best be made by landing slightly wheels first with generally less than normal flap angle, all other conditions mentioned above remaining the same, except that some rudder should be used just prior to contact to head the airplane in the direction of motion over the ground (“down-wind rudder”).

#### **WARNING**

Use brakes with caution until the tail wheel is on the runway.

### **21. TAKE-OFF IF LANDING IS NOT COMPLETED.**

a. In the event that landing is not completed, the throttle should be advanced smoothly, followed by the propeller control, if necessary. Landing gear retraction should then be started, followed immediately by opening of the cowl and oil cooler flaps. The wing flaps should then be retracted. This procedure should be followed to avoid overheating the power plant, which would result if protracted operation were undertaken in the landing condition.

#### **NOTE**

It is recommended that, unless compelling reasons exist for not doing so, time be taken to go through the above procedure, followed by the usual landing sequence.

### **22. AFTER LANDING.**

- a. **CHECK-OFF LIST:**
- (1) Open cowl flaps.

- (2) Retract arresting hook (carrier).
- (3) Retract wing flaps.
- (4) Unlock tail wheel (field).
- (5) Taxi with smallest possible throttle opening, to avoid excessive use of brakes.
- (6) In the event of prevailing low temperature or low temperature forecast, viz., below  $-5^{\circ}\text{C}$ . ( $+20^{\circ}\text{F}$ .), operate the oil dilution system before stopping the engine, in accordance with paragraph 5. *a*. In addition, observe the precautions in diluting listed in paragraph 5. *b*.

### 23. STOPPING.

#### *a*. CHECK-OFF LIST:

- (1) Cowl flaps — “FULL OPEN” while idling and for at least 10 minutes after stopping.
- (2) Intercooler flap — “OPEN” to cool accessory compartment.
- (3) Oil cooler flaps — “OPEN.”
- (4) Propeller control — “TAKE-OFF RPM” (“DOWN”).
- (5) Carburetor air control — “DIRECT” (“IN”).
- (6) Throttle — Set for 800-1000 rpm to cool engine (cylinder temperatures below  $200^{\circ}\text{C}$ . —  $392^{\circ}\text{F}$ .).
- (7) Mixture control — “IDLE CUT-OFF.”
- (8) Ignition switch — “OFF” when propeller stops rotating.

### WARNING

Do not turn the ignition switch violently at any time, since it is possible to break the stops, thus leaving both magnetos “ON.” Check for proper positioning of the switch pointer.

- (9) Battery switch — “OFF.”

### 24. BEFORE LEAVING THE PILOT'S COMPARTMENT.

*a*. Install the surface control lock. The surface control lock is installed by hooking the extension bar into the left rudder pedal, inserting the left and right hand pins into recesses in the foot troughs, and securing the clamp around the stick. The lock is not normally carried in the airplane.

### NOTE

Make sure that the surface controls are “LOCKED” whenever the airplane is parked; otherwise, damage to the rudders, elevators, or ailerons may result.

### 25. TIEING DOWN.

*a*. If the weather conditions are unfavorable or if the airplane is to remain parked for an appreciable length of time, make certain that the airplane is tied down securely. Tie-down links are provided in the outer panels and on the tail wheel mechanism. Additional tie-down points are the towing links on the landing gear and the base of the landing gear drag links.

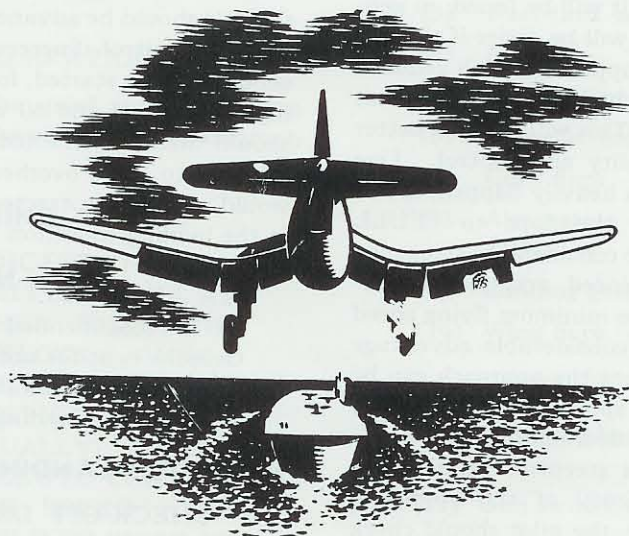



## Section III

### FLIGHT OPERATING DATA

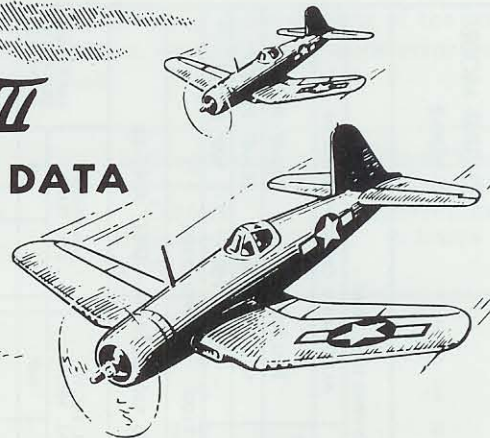
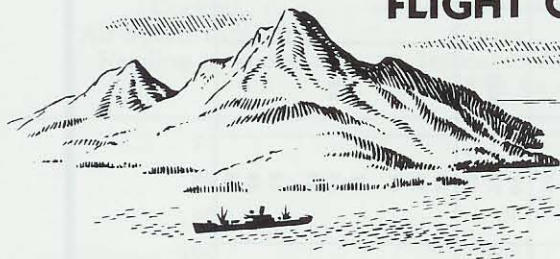

#### 1. SPECIFIC ENGINE FLIGHT CHART.

a. The specific engine flight chart summarizes the operating limits of the engine. It gives the supercharger setting, manifold pressure, rpm, altitude range and BHP for several different operating conditions. Other conditions affecting the operation of the power plant, such as oil pressures and temperatures, are also specified. The rpm's and manifold pressures at a given supercharger control setting for take-off, military, and war emergency operation must never be exceeded; the five-minute time limit for each of these conditions should not be exceeded. The altitudes corresponding to the supercharger control settings show the approximate altitude range for operation at that setting. Operation below the lower altitude shown for a given supercharger control setting should

not be undertaken as less power will be obtained, carburetor air temperatures will be dangerously high, and fuel economy will suffer. When changing power conditions, the controls should be adjusted to the settings appropriate to the new condition in the sequence which follows, in order to avoid excessive pressures within the cylinders:

- (1) Increasing power — Mixture, rpm, manifold pressure.
- (2) Decreasing power — Manifold pressure, rpm, mixture.

b. In order to obtain the maximum in performance and reliability from the engine, when urgently needed under combat conditions, it is recommended that the pilot operate it at its power limits no more often than is necessary for proper familiarity and training.

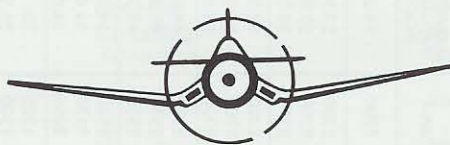

AIRPLANE MODELS  
F4U-1, FG-1, F3A-1

**SPECIFIC ENGINE  
FLIGHT CHART**

ENGINE MODEL  
R-2800-8

CONDITION	FUEL PRESSURE (LB. SQ. IN.)	OIL PRESSURE (LB. SQ. IN.)	OIL TEMP.					MAX. PERMISSIBLE DIVING RPM: 3060	
			°C	°F				CONDITION	ALLOWABLE OIL CONSUMPTION
DESIRED	17	60-90	60-80	140-194				NORMAL RATED (MAX. CONT.)	32 U.S. QT/HR    53 IMP. PT/HR
MAXIMUM	18	100	100	212				MAX. CRUISE	16 U.S. QT/HR    26 IMP. PT/HR
MINIMUM	16	50	40	104				MIN. SPECIFIC	— U.S. QT/HR    — IMP. PT/HR
IDLING	7	25						OIL GRADE: (S) 1100    (W) 1100	

SUPERCHARGER TYPE: TWO STAGE, TWO SPEED.

FUEL GRADE: 100 130 OCTANE — SPEC. AN-F-28.

OPERATING CONDITION	RPM	MANIFOLD PRESSURE (BOOST)	HORSE- POWER	CRITICAL ALTITUDE		BLOWER	USE LOW BLOWER BELOW:	USE NEUTRAL BLOWER BELOW:	MIXTURE CONTROL POSITION	FUEL FLOW (GAL. HR.)		MAXIMUM CYL. TEMP.		MAXIMUM DURATION (MINUTES)
				WITH RAM	NO RAM					U.S.	IMP.	°C	°F	
				TAKE-OFF	2700					54.0	2000	S.L.	S.L.	
WAR EMERGENCY	2700	57.5	2250	S.L.	S.L.	N	17000	8000	AUTO RICH	245	205	—	—	5
	2700	59.0	2135	15000	12500	L								
	2700	59.5	1975	20000	17000	H								
MILITARY	2700	52.5	2000	2500	2000	N	20000	6000	AUTO RICH	290	240	260	500	5
	2700	53.0	1800	18500	16000	L								
	2700	53.0	1650	23000	21000	H								
NORMAL RATED (MAX. CONT.)	2550	44.0	1675	7000	5500	N	21000	10000	AUTO RICH	220	185	260	500	—
	2550	49.5	1625	19000	16500	L								
	2550	49.5	1550	24000	22000	H								
MAXIMUM CRUISE	2150	34.0	1070	10000	10000	N	22000	13000	AUTO LEAN	83	69	232	450	
	2150	34.0	970	20500	20500	L								
	2050	34.0	950	26000	26000	H								
MINIMUM FUEL CONSUMPTION	1300	30	570	5000	5000	N	22000	15500	AUTO LEAN	42	35	232	450	
	1500	26.5	570	10000	10000									
	1800	23.5	600	15500	15500									
	1550	28	600	15500	15500	L								
	1700	26	595	20000	20000									
	1800	25	610	22000	22000									
	1700	28	660	22000	22000	H								
	1750	25.5	600	25000	25000									
	2000	25.5	650	30000	30000									

REMARKS:

(1) RED FIGURES HAVE NOT BEEN FLIGHT CHECKED.

## 2. AIR SPEED CORRECTION TABLE.

The calibration below represents the air speed head (pitot tube) position error and gives the corrected

indicated air speed for a given reading of the cockpit air speed indicator assuming zero scale error for the instrument itself.

Cockpit Air Speed Indicator Reading in knots	Clean Condition — Flaps Up		Landing Condition — Flaps Down	
	Correct Indicated Air Speed in knots	Correction in knots	Correct Indicated Air Speed in knots	Correction in knots
70	—	—	67	-3
80	—	—	78	-2
90	88	-2	89	-1
100	99	-1	100	0
110	110	0	111	+1
120	122	+2		
130	132	+2		
140	143	+3		
150	153	+3		
160	163	+3		
170	174	+4		
180	184	+4		
190	194	+4		
200	205	+5		
220	225	+5		
240	246	+6		
260	266	+6		
280	287	+7		
300	308	+8		
350	—			
400	—			

## 3. AIR SPEED LIMITATIONS.

ITEM	OPERATION	RESTRICTION
Airplane	Max. Diving Speed	Dependent on Altitude (See Section II, paragraph 14.d.)
Landing Gear	Lowering	200 knots
Dive Brake	Extending	260 knots
	Retracting	350 knots
Wing Flaps		
“Blow-up” Operating (0° to 50°)	Max. Speed	200 knots
“Blow-up” Inoperative (0° to 20°)	Max. Speed	200 knots
(50°)	Max. Speed	130 knots
Cabin	Open	300 knots
Ailerons	Full Throw	300 knots
Cooling Flaps (cowl, intercooler, oil cooler)	Open	No Restriction (protected by relief system)
Center Drop Tank	Diving	375 knots
Twin Pylon Drop Tank	Diving	Dependent on Altitude (See Section II, paragraph 14.d.)



## 1. ENGINE FAILURE DURING FLIGHT.

a. Engine failure is noticeable in either of the following conditions:

- (1) Freezing of engine.
- (2) Drop in altitude and loss of speed.

### NOTE

If the engine fails but does not freeze, no absence of engine noise is apparent since the windmilling propeller simulates normal engine operation. Also, in this condition manifold pressure can be increased and decreased normally, and the propeller blade angle can be changed within certain limits. While the propeller is windmilling, the hydraulic system can be operated normally. However, if the engine should freeze or rough operation should necessitate stopping the engine by placing the propeller governor control in high pitch (minimum rpm) position, the hydraulically controlled units must be operated by the hand pump, with the exception of the landing gear which must be lowered by means of the emergency CO<sub>2</sub> extension mechanism.

b. If altitude permits, attempt to find the cause of engine failure by the following procedure:

- (1) Electric auxiliary fuel pump — "ON."
- (2) Check fuel pressure. If fuel pressure has dropped, pull the throttle aft to reduce manifold pressure to approximately 20 inches Hg. and turn the fuel selector valve to "RESERVE."

### NOTE

Leave the electric auxiliary fuel pump "ON" and the selector valve on "RESERVE" since it takes some time for the air and vapor to get out of the fuel lines.

c. If it is apparent that the fault does not lie in fuel system operation, and altitude still permits, check the following:

- (1) Move the mixture control forward to "EMERGENCY RICH" position.
- (2) Test the magnetos individually.

d. If, after completing the above operations, the engine does not start, prepare for an emergency landing, following the procedure given in paragraph 4, and in Section II, paragraph 20. e.

### NOTE

The gliding ratio of these airplanes in the clean condition at 140 knots indicated air speed (best gliding air speed) is 13:1.

## 2. CABIN EMERGENCY RELEASE.

a. The entire cabin section can be released in flight in case of emergency. The two release handles, one on either side of the cabin structure, are plainly marked "CABIN EMERGENCY RELEASE." These two handles are safety-pinned to prevent inadvertent release of the cabin and to permit using the handles for pushing the cabin fully closed. The safety pins (painted RED) are attached to wire loops adjacent to the release handles and must be pulled free (aft) before the release handles can be moved. The release handles disengage the front rollers from the cabin. As the cabin is pushed upward, the rear rollers are disengaged and the cabin is freed of the airplane, to be carried away by the slipstream.

b. To release the cabin in an emergency in flight:

- (1) Pull the safety pin loops.
- (2) Pull both cabin release handles inboard and push them forward.
- (3) Break cabin free with upward push on the release handles.

## NOTE

On airplanes without "Raised Cockpits" the cabin must be partially opened before lifting upward on the release handles.

### 3. EMERGENCY LANDING GEAR OPERATION.

a. The landing gear can be extended even if there is complete failure of the hydraulic system, that is, even if no action is obtained on operation of the hand pump. The emergency landing gear operation is actuated by a CO<sub>2</sub> system on the main gear and a spring system on the tail wheel. Before resorting to the emergency landing gear release, the pilot should definitely ascertain that the hydraulic pressure is not up and will not come up after actuation of the hand pump. Considerable pumping is necessary in order to build up accumulator pressure if no check valve is installed, as is the case on early Model F4U-1 airplanes, and if, during the early stages, little resistance is felt at the pump handle. Once the accumulator pressure is built up, however, more pressure can be exerted on the landing gear extension mechanisms by means of the hand pump than by means of the CO<sub>2</sub> system.

b. The following procedure is used for emergency extension of the landing gear in case of actual failure of the hydraulic system:

(1) Close throttle and reduce speed to about

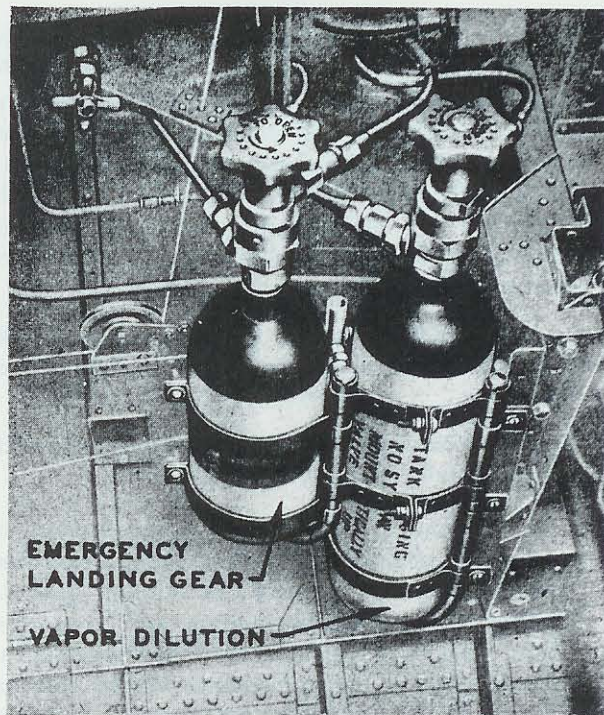

Fig. 30 — CO<sub>2</sub> Bottles — Emergency Landing Gear and Vapor Dilution

110 knots.

(2) Move landing gear control to "DOWN."



(3) Turn emergency landing gear release valve, located on left side of cockpit. Early Model F4U-1 airplanes are equipped with a pull handle for operating the valve. On all airplanes equipped with a vapor dilution system, with the exception of airplanes provided with a pull handle release, a safety pin is installed on the landing gear emergency CO<sub>2</sub> release valve to prevent inadvertent lowering of the landing gear when wing tank purging is desired.

(4) Further reduce speed to about 90 knots (about five knots above stall) while the landing gear is extending.

(5) Check indicators that landing gear and tail wheel are fully locked "DOWN."

c. The emergency extension of the landing gear is started at a comparatively high speed so that the air-flow will assist in opening the landing gear doors. Turning the emergency landing gear release valve admits CO<sub>2</sub> to a sequence valve which actuates two unloader valves, the unloader valves by-passing the pressure at the bottom of the landing gear and tail wheel struts directly back to the hydraulic reservoir. The sequence valve in turns admits CO<sub>2</sub> pressure to the top of the landing gear struts, thereby extending the gear. The early models incorporating a pull handle emergency release work on much the same principle. In this case, pulling the release first actuates the unloader valves and then operates a cutter valve which releases the CO<sub>2</sub> pressure to the landing gear struts (see figures 30 and 32). For hydraulic operation refer to Section I, paragraph 7. b. (3).

#### 4. BELLY LANDINGS.

a. Preparation for belly landing:

- (1) Landing gear — "UP."
- (2) Landing flaps — "DOWN."
- (3) Shoulder harness — "LOCKED."
- (4) Release cockpit cabin sliding section.
- (5) Prior to contact with ground:

(a) Switches (battery, generator, ignition) — "OFF."

(b) Fuel selector — "OFF."

#### 5. WATER LANDINGS (DITCHING).

a. The same procedure as that outlined above for belly landings is applicable to ditching.

#### NOTE

THESE AIRPLANES HAVE EXCELLENT WATER LANDING CHARACTERISTICS DUE TO THE INVERTED GULL WING WHICH CAUSES THEM TO PLANE ON CONTACT WITH THE WATER. BECAUSE OF THE PLANING FEATURE A COMPLETE FULL-STALL LANDING IS NOT NECESSARY.

#### 6. LIFE RAFT.

a. The one-man, parachute-type life rafts are used by pilots operating these airplanes. No flotation gear is provided.

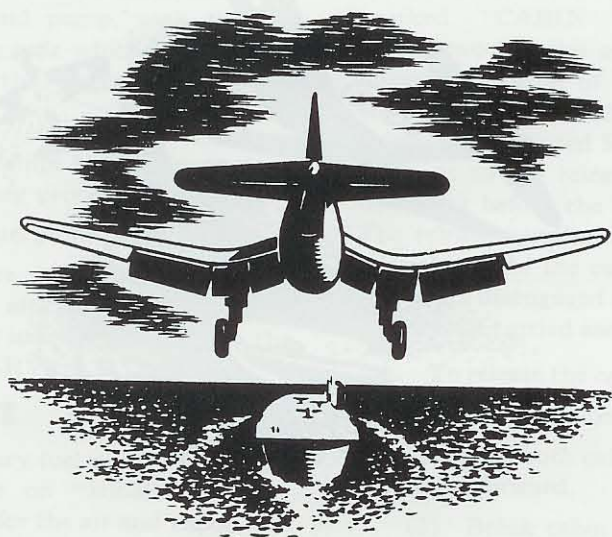

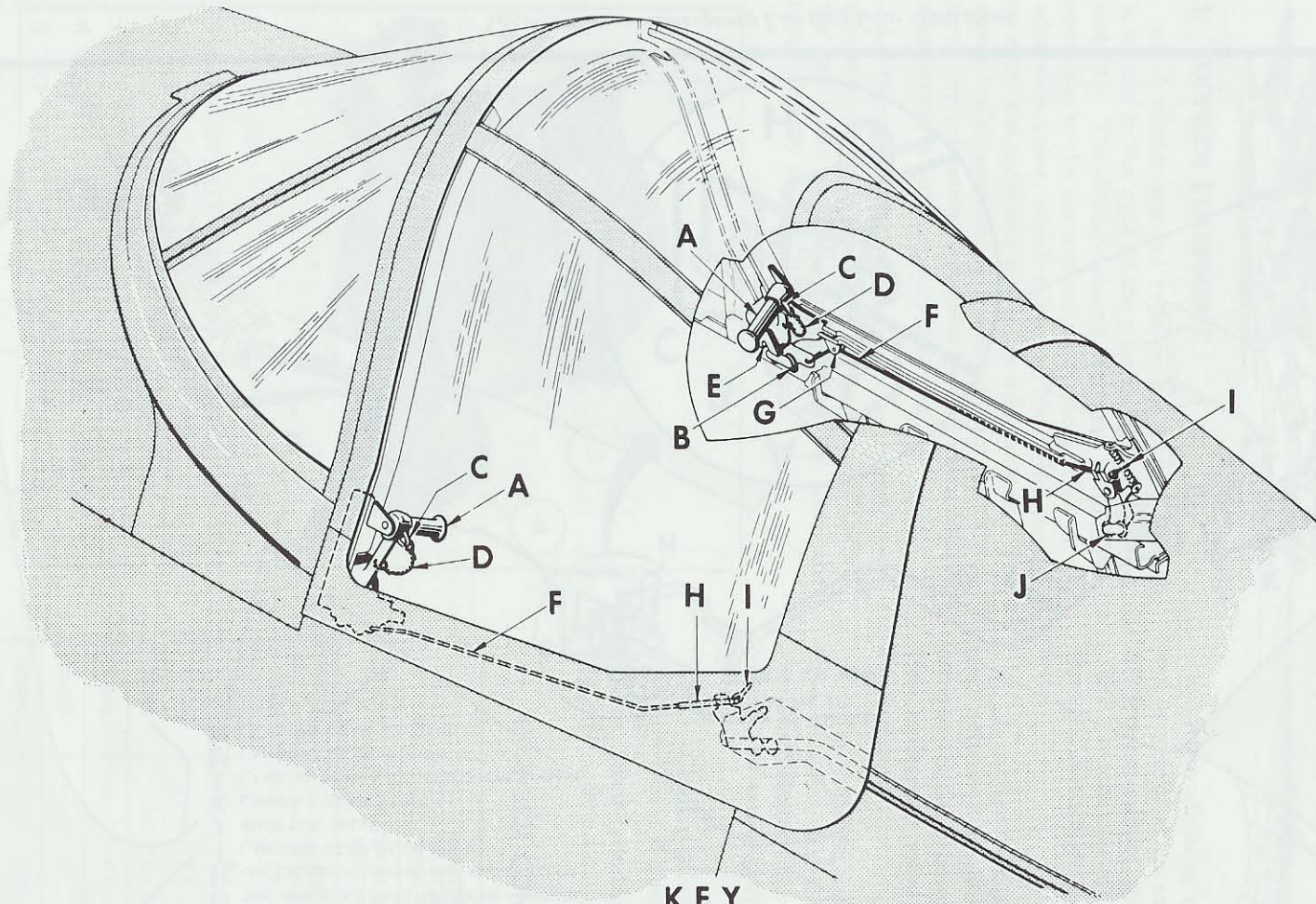

**KEY**

- |  |                                     |
|--|-------------------------------------|
| <b>A</b> CABIN EMERGENCY<br>RELEASE HANDLE (PAINTED RED) | <b>F</b> CABLE (TO AFT RELEASE PIN) |
| <b>B</b> FRONT ROLLERS                                   | <b>G</b> CABLE ROLLER               |
| <b>C</b> SAFETY PIN (PAINTED RED)                        | <b>H</b> AFT RELEASE PIN            |
| <b>D</b> WIRE LOOP (PAINTED RED)                         | <b>I</b> LOCK WIRE                  |
| <b>E</b> FORWARD RELEASE PIN                             | <b>J</b> REAR ROLLERS               |

*Fig. 31 — Cabin Emergency Release*

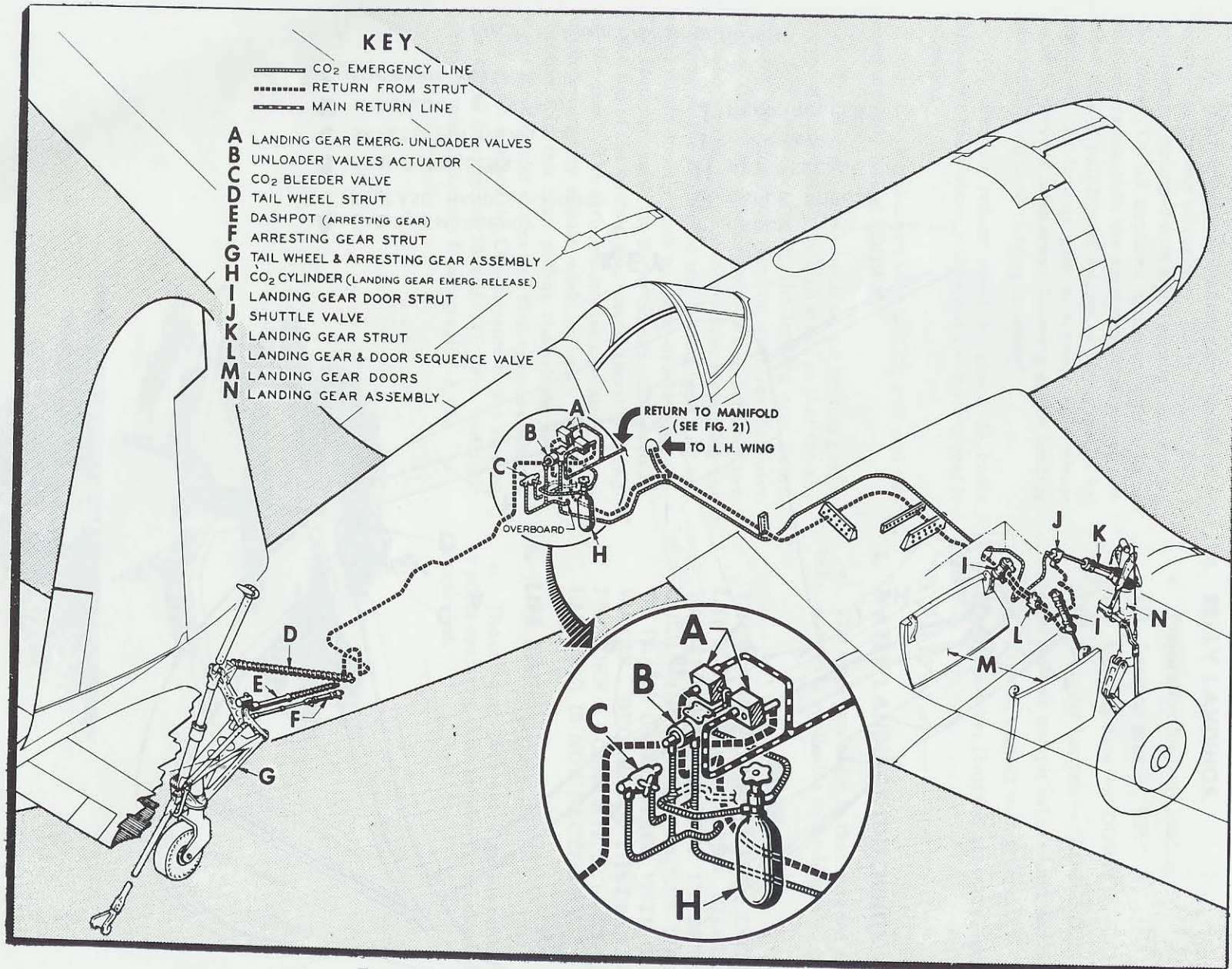
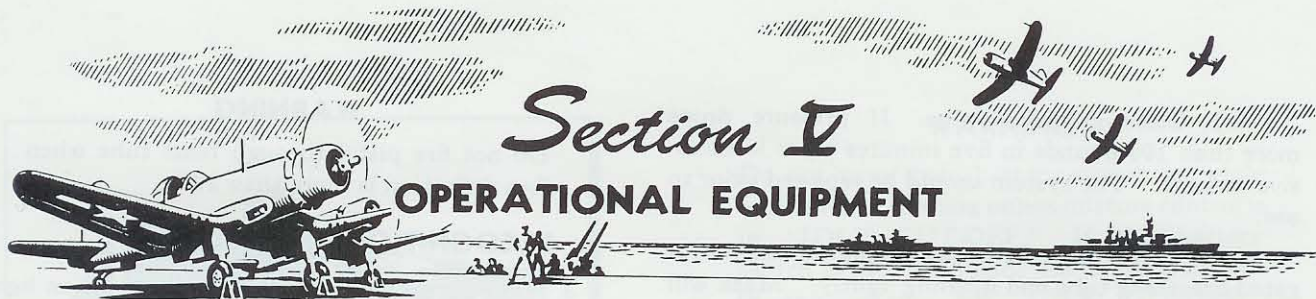

Fig. 32 — CO<sub>2</sub> System — Emergency Landing Gear Operation





**1. OXYGEN EQUIPMENT.**

a. A diluter-demand type oxygen supply system is located to the right of the pilot's seat (see figures 5 and 33). The diluter-demand regulator is similar in operation to the demand regulator except that an air admission valve, which allows air from the outside to enter the breathing system is incorporated. The amount of air admitted is dependent upon the altitude up to approximately 30,000 feet beyond which 100 per cent oxygen is automatically delivered.

b. During normal operations the diluter lever should be turned to the "ON" position, thus obtaining the maximum economy and endurance from the oxygen supply aboard.

c. When climbing directly to altitudes of 30,000 feet or above, at an average rate of climb exceeding 500 feet per minute, the diluter valve shall be turned "OFF" before take-off and 100 per cent oxygen used throughout the flight until return to altitude of 10,000 feet.

d. It is intended that the emergency valve shall be used only in flight above 35,000 feet, or if diluter-demand regulator becomes inoperative. When used, open emergency valve slowly and obtain minimum flow required.

e. The following items shall be checked at regular intervals when the airplane is on the ground, and whenever possible before flights in which oxygen is to be used, to assure proper functioning of the oxygen system:

(1) Check regulator emergency by-pass valve to determine that it is closed.

(2) Open cylinder valve. Pressure gage should read  $1800 \pm 50$  p.s.i. if the cylinder is fully charged.

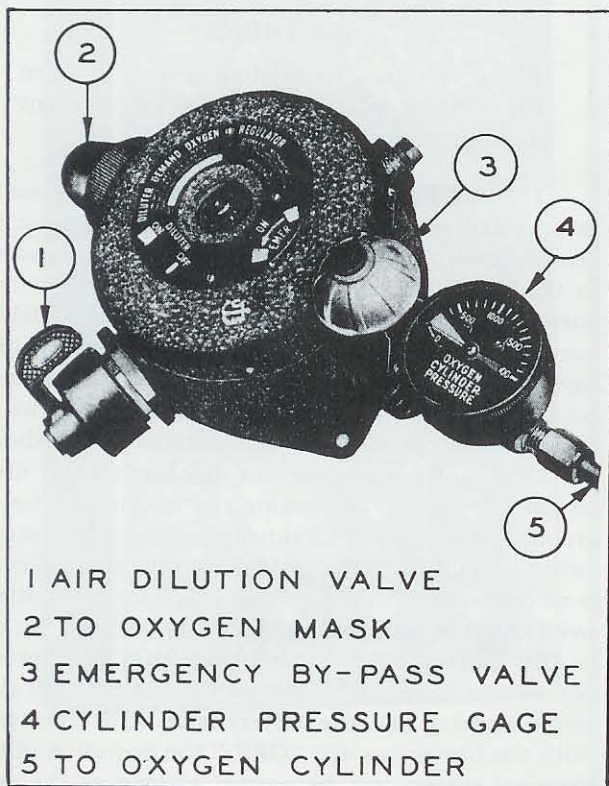

*Fig. 33 — Diluter-Demand Regulator*

**OXYGEN CONSUMPTION TABLE**

ALTI-TUDE IN FEET	DILUTER-DEMAND REGULATOR WITH DILUTER "OFF"	DILUTER-DEMAND REGULATOR WITH DILUTER "ON"
	ENDURANCE HOURS	ENDURANCE HOURS
0	1.5	6.8
5000	1.8	8.1
10000	2.1	9.8
15000	2.6	10.6
20000	3.3	9.3
25000	4.1	5.8
30000	5.2	5.2
35000	6.5	6.5
40000	8.3	8.3

(3) Close cylinder valve. If pressure drops more than 100 pounds in five minutes there is excessive leakage. The system should be repaired prior to use.

(4) Check mask fit by squeezing off the corrugated breathing tube and inhaling lightly. Mask will collapse on face if there is no leakage. **DO NOT USE A MASK THAT LEAKS.** Never check mask fit, as outlined, with **EMERGENCY FLOW "ON."**

(5) Open cylinder valve. Breathe several times to determine that regulator is functioning properly. Check emergency by-pass valve by turning handle toward "ON" position until the oxygen flows into the mask. Close emergency valve.

(6) Upon completion of oxygen flight, close cylinder valve.

## 2. RADIO EQUIPMENT.

a. All airplanes delivered will have AN/ARR-2 equipment and AN/ARC-5 radio sets installed. In addition, mounting provisions are made for either AN/APX-1 or ABA recognition equipment. Controls for the radio apparatus are located on the right side of the cockpit. For complete information regarding the installation and operation of the radio equipment refer to the radio arrangement drawings and to the instruction books for the particular type of equipment being used.

## 3. SIGNAL PISTOL.

a. The AN-M8 pyrotechnic pistol is located to the right of the pilot's seat. The container, which holds six cartridges, is located just below the main instrument panel (see figures 3 and 34).

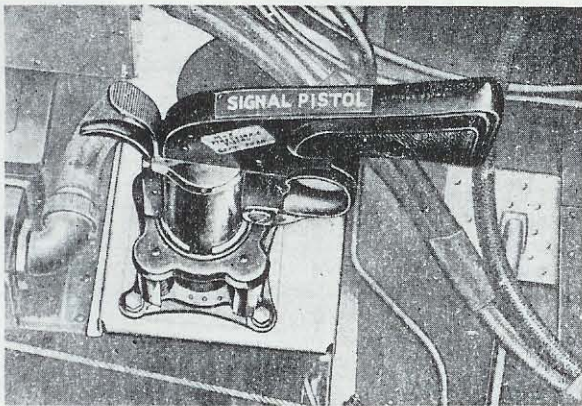

Fig. 34 — Signal Pistol

## WARNING

Do not fire pistol through blast tube when flap deflection is more than 20°

## 4. RECOGNITION LIGHTS.

a. The control switches for the recognition lights are located on the pilot's right hand panel. Refer to figures 5 and 35

## 5. ELECTRICAL SYSTEM.

a. **GENERAL.** — The electrical power for the airplane is supplied by a 24-volt system. A voltammeter located on the right auxiliary instrument panel indicates the generator output in amperes, which will vary according to the charge condition of the battery and to the amount of electrical equipment being used. A push button is incorporated to indicate voltage. With the engine stopped, or at any time the rpm is less than 1000, push the button in to indicate battery voltage. Under normal flight conditions push the button in to indicate generator voltage. The generator voltage should read between 27 and 29 volts.

## WARNING

If the voltammeter reading is over 29, turn the battery switch to "OFF" to prevent damage to the battery.

(1) **BATTERY SWITCH.** — A battery switch is provided which disconnects the battery from the remainder of the electrical system. With this switch in the "OFF" position, the generator cannot deliver current to the battery, nor can the battery deliver current to any external load except the recognition lights and the inertia switch. When the airplane is on the ground with engine off, the battery switch, recognition light switches, and inertia switch should be "OFF." This will prevent any inadvertent drain on the battery. For starting the engine and for all ground running and flight operation, the battery switch should be "ON." If, however, any difficulty is encountered with the voltage regulator, the battery switch may be switched to "OFF" to prevent damage to the battery. Smoke emitting from the battery box on the lower right side of the cockpit will give ample warning that the battery is being overcharged. With the battery switch "OFF," the operation of the electrical system will be normal as long as the generator is charging (engine turning more than approximately 1000 rpm), since the generator will feed current directly into the system.

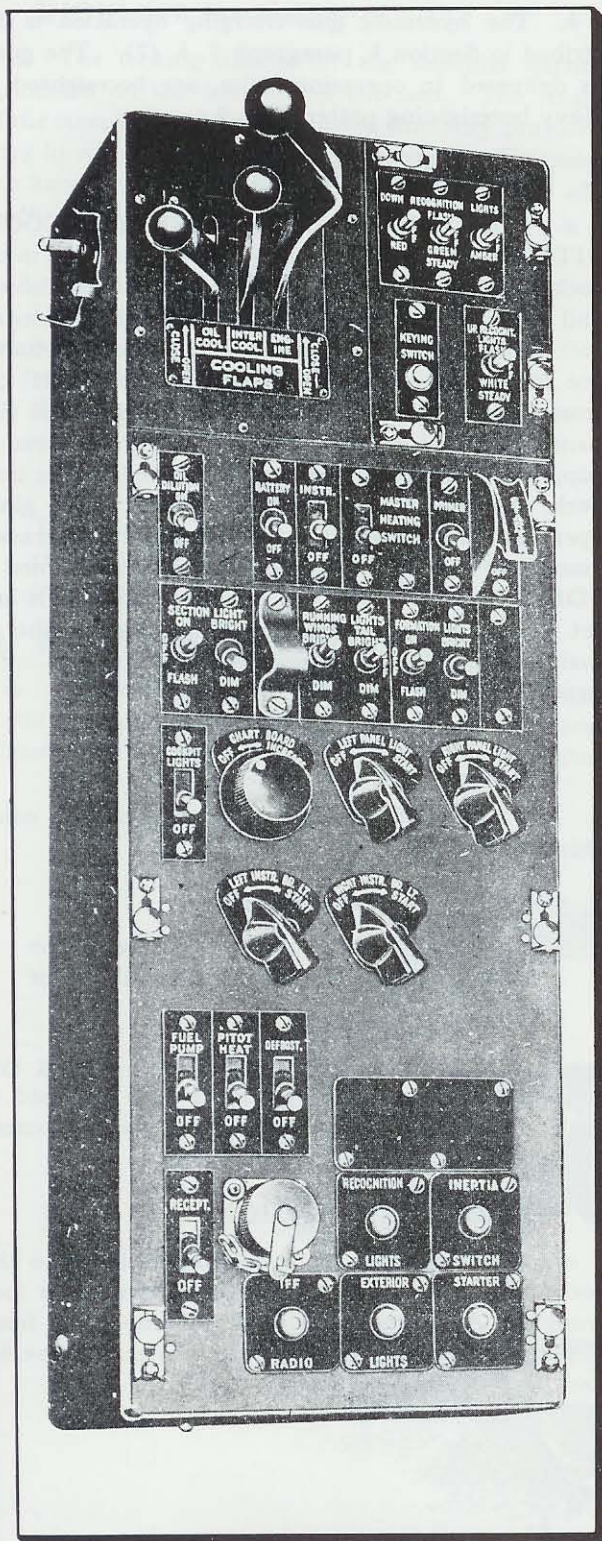

Fig. 35 — Pilot's Distribution Box

## WARNING

Do not turn main battery switch on while engine is not running unless mixture control is in "IDLE CUT-OFF." If the battery switch is turned on with the mixture control in any position but "IDLE CUT-OFF," and the fuel pump switch is on, the lower cylinders will be flooded with raw fuel, resulting in damage to the engine when it is subsequently started.

## CAUTION

Since the battery switch is designed for a normal current load not exceeding 50 amperes (75 amperes on airplanes with Bureau serial number 17932 F4U-1, 13342 FG-1, 04740 F3A-1 and subsequent), care should be taken not to impose any severe loads on the electrical system unless the generator is delivering current. With the generator delivering power, the current comes directly from the generator and, hence, cannot harm the battery switch.

(2) **INSTRUMENT SWITCH.** — A single switch for operating the electric fuel gage, electric oil temperature gage, carburetor air temperature warning light, stall warning light, and remote compass is located on the right hand side panel adjacent to the battery switch and is entitled "INSTRUMENT SWITCH." It is a circuit breaker type switch which will spring to "OFF" if a momentary short occurs in that part of the electrical system. This switch is to be used in conjunction with the battery switch and must be "ON" for all airplane and engine operation.

(3) **PITOT HEATER.** — Heat can be supplied to the air speed pitot head on the left wing tip to prevent its freezing. The pitot heater switch should be switched to "ON" at any time icing conditions are encountered.

(4) **CIRCUIT BREAKERS.** — Circuit breaker buttons for the recognition lights, starter, exterior lights, inertia switch, armament, individual guns, gun camera, gun sight, and bomb arming and release are installed on the right and left side panels in the cockpit. The circuit breakers replace the electric fuse system formerly required in airplanes. If an electrical circuit is broken due to a short (button sprung out), push the button corresponding to the proper circuit.

(a) The remainder of the electrical circuits (fuel pump, pitot head, instrument lights, etc.), have circuit breakers incorporated in the respective "ON"- "OFF" switches. When a short occurs in one of the circuits, the switch will be thrown automatically to "OFF." Return the switch to the "ON" position. If the circuit is definitely shorted, the button will pop out again or the switch will snap back to "OFF."

(5) **TWIN PYLON BOMB AND DROPPABLE FUEL TANK SWITCHES.** — A set of switches, located on the cowl deck above the instrument panel, have been provided for arming bombs and for selecting the bomb or droppable fuel tank to be released. A thumb switch, located on the pilot's control stick, has been provided for release of the bomb or droppable fuel tank. For information concerning manual release see Section I, paragraph 4. d. (2).

#### NOTE

Selection of the manner of release (manual or electrical) will depend on the type of bomb adapter installed on the particular airplane.

### 6. GUN INSTALLATION.

a. The master gun switch, the switches controlling the firing of the six guns, the gun sight switch, the gun sight rheostat, the gun heater switch, and the switch-type circuit breakers are located on the sub-panel, just below the wing flap control on the left side. On later airplanes ("Raised Cockpit" design), the switches and gun sight rheostat are located on the cowl deck above the instrument panel, the circuit breaker buttons being located on the left sub-panel, just below the wing flap control.

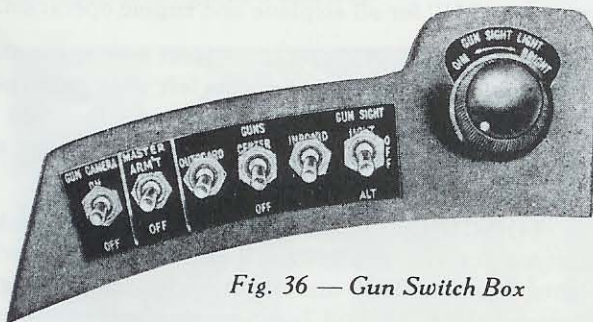

Fig. 36 — Gun Switch Box

b. The hydraulic gun charging operation is described in Section I, paragraph 7. b. (7). The guns, as delivered to operating units, are boresighted to Navy boresighting pattern No. 2.

### 7. HEATING EQUIPMENT.

a. **WINDSHIELD DEFROSTER AND COCKPIT HEATER.** — A combustion heater, located in the cockpit, supplies heat for defrosting the windshield and heating the cockpit. A master heat control switch, located on the right hand side panel, actuates the heating system as a whole. An individual defroster switch is also located on the right hand side panel, and must be moved to "ON" before heat can be supplied. The regulator control located on the cowl deck, just below the windshield bullet-proof glass, operates a butterfly valve for directing the necessary amount of heat flow to the windshield when turned to "DEFROST." When the regulator control is not set for maximum heating flow for defrosting, the remaining heat is by-passed into the cockpit. For heating:

- (1) Master heat control switch — "ON."
- (2) Defroster switch — "ON."
- (3) Regulate required amount of heat to windshield or cockpit.

#### CAUTION

Do not operate the cockpit heater while the airplane is on the ground or during take-off or landing.

b. **GUN HEATING.** — The gun heating system consists of electrically heated pads attached to each gun and a circuit breaker type switch located on the left hand panel in the cockpit.

### 8. COCKPIT VENTILATION.

a. The ventilator for supplying fresh air to the cockpit is located forward of and between the foot troughs. Adjustment, to vary the amount of fresh air, can be made by rotating the butterfly valve by foot.



## 9. SHOULDER HARNESS.

a. The locking handle for the shoulder harness is located on the left side of the seat. The length of the straps should be so adjusted that they provide a snug fit with the handle locked (forward). Releasing the handle will permit the pilot to lean forward and reach any desired controls.

### WARNING

Under no circumstances should the shoulder harness be omitted, using the seat belt only, since, without the shoulder straps connected, the belt release may bind on attempting to open it.

### NOTE

The harness should go around the upper crosstube of the seat support, not directly over the seat back.

## 10. RUDDER PEDAL ADJUSTMENT.

a. The position of the rudder pedals is adjustable to suit the comfort of the pilot by pressing forward and inboard with the heel on the lever located on the after

side of the pedal arm while the toe rests on the pedal. The pedals can then be shifted fore or aft as desired. A total adjustment of six inches is provided.

## 11. BRAKE PEDAL ADJUSTMENT.

a. A screw adjustment knob, located on the outboard side of each pedal, is provided for adjustment of the brake pedal fore-and-aft tilt angle, and should be adjusted by each pilot in order to obtain best braking action.

## 12. SEAT ADJUSTMENT.

a. The pilot's seat has a vertical adjustment of nine inches in one-inch increments, and is controlled by a handle on the right side of the seat.

## 13. NAVIGATION ANTENNA.

a. The control for extending and retracting this antenna is located on the right side of the cockpit, just below the cabin track. The antenna is extended by unlatching, pulling the handle aft, and latching. The antenna should be extended only when actually being used in flight, since it causes a certain definite, though small, loss in maximum speed (1 mph).

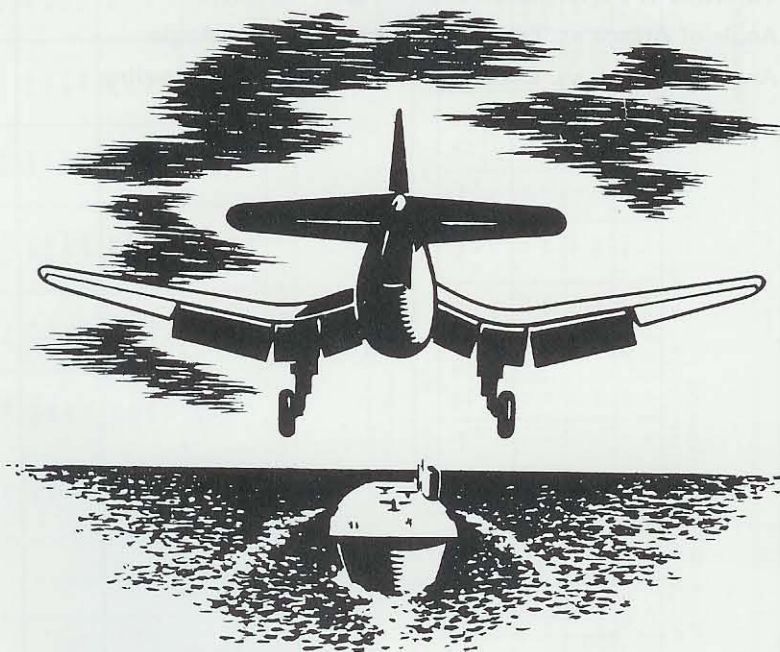

# Appendix I

## FLIGHT OPERATING CHARTS

The following charts are included:

Chart

Take-off, Climb and Landing Chart

Variation of Performance with Weight — Plate I

Variation of Performance with Weight — Plate II

Angle of Attack at Terminal Velocity vs. Dive Angle

Angle of Attack vs. Cockpit Air Speed Indicator Reading

AIRPLANE MODELS  
F4U-1, FG-1, F3A-1

# TAKE-OFF CLIMB AND LANDING CHART

ENGINE MODEL  
R-2800-8

## TAKE-OFF DISTANCE (IN FEET) FOR 30° FLAP SETTING

GROSS WEIGHT (IN LBS.)	HEAD WIND (KNOTS)	HARD SURFACE RUNWAY						SOD TURF RUNWAY						SOFT SURFACE RUNWAY					
		AT SEA LEVEL		AT 3000 FT		AT 6000 FT		AT SEA LEVEL		AT 3000 FT		AT 6000 FT		AT SEA LEVEL		AT 3000 FT		AT 6000 FT	
		GROUND RUN	TO CLEAR 50' OB	GROUND RUN	TO CLEAR 50' OB	GROUND RUN	TO CLEAR 50' OB	GROUND RUN	TO CLEAR 50' OB	GROUND RUN	TO CLEAR 50' OB	GROUND RUN	TO CLEAR 50' OB	GROUND RUN	TO CLEAR 50' OB	GROUND RUN	TO CLEAR 50' OB	GROUND RUN	TO CLEAR 50' OB
11700	0	680	1350	810	1690	1020	2090	710	1380	850	1650	1070	2150*	790	1460	960	1770	1250	2330
	15	450	980	550	1190	700	1560	470	1000	580	1210	740	1600	520	1050	650	1290	870	1720
	30	260	650	340	810	440	1070	270	660	350	890	460	1100	310	690	400	870	540	1180
	45	120	360	170	470	230	650	130	370	190	480	250	670	140	380	200	500	290	710
13100	0	910	1870	1080	2270	1370	3070	950	1910	1140	2330	1460	3160	1090	2090	1330	2520	1740	3440
	15	620	1380	750	1690	980	2340	650	1410	790	1740	1040	2400	750	1510	920	1860	1240	2600
	30	380	830	460	1160	620	1640	400	850	490	1190	660	1680	450	910	570	1270	790	1810
	45	190	550	260	780	360	1030	200	560	280	730	380	1050	230	590	320	780	450	1130
14200	0	1110	2380	1330	2970	1730	4250	1170	2440	1410	3050	1860	4380	1370	2640	1680	3310	2290	4810
	15	770	1780	940	2250	1240	3260	810	1830	1000	2300	1330	3360	950	1960	1180	2490	1640	3660
	30	480	1240	600	1580	810	2340	510	1260	640	1620	870	2400	590	1350	760	1740	1070	2600
	45	260	760	340	990	490	1530	280	780	370	1010	530	1560	320	890	430	1080	650	1680

NOTE: INCREASE DISTANCE 10% FOR EACH 10 C (20 F) ABOVE 0 C (32 F)

ENGINE LIMITS FOR TAKE OFF 2700 RPM AND 54" HG. AT SEA LEVEL

## CLIMB DATA

FOR COMBAT CLIMB: Use Military Power for 5 Min. Only  
— Then Normal Power

See Specific Engine Flight Chart for Operating Limits

FOR FERRY CLIMB: Use Maximum Cruising Power

GROSS WEIGHT (IN LBS.)	TYPE OF CLIMB	SEA LEVEL TO 5000 FT. ALT.				TO 10000 FT. ALT.				TO 15000 FT. ALT.				TO 20000 FT. ALT.				TO 25000 FT. ALT.				TO 30000 FT. ALT.									
		BEST I.A.S. (KNOTS)	FT. MIN. AT ALT.	TIME FROM SL	FUEL FROM SEA LEVEL		BEST I.A.S. (KNOTS)	FT. MIN. AT ALT.	TIME FROM SL	FUEL FROM SEA LEVEL		BEST I.A.S. (KNOTS)	FT. MIN. AT ALT.	TIME FROM SL	FUEL FROM SEA LEVEL		BEST I.A.S. (KNOTS)	FT. MIN. AT ALT.	TIME FROM SL	FUEL FROM SEA LEVEL		BEST I.A.S. (KNOTS)	FT. MIN. AT ALT.	TIME FROM SL	FUEL FROM SEA LEVEL						
					U.S.	IMP.				U.S.	IMP.				U.S.	IMP.				U.S.	IMP.				U.S.	IMP.					
11700	Combat	135	2700	2	18	15	135	2700	4	28	23	130	2600	6	36	29	130	1900	8	45	36	125	1500	11	55	44	120	500	19	79	64
	Ferry	130	1500	4	14	11	130	1400	7	19	15	130	1200	11	25	20	130	1000	16	31	25	125	700	22	39	31	—	—	—	—	
13100	Combat	135	2100	2	20	16	135	2100	5	33	27	130	1600	8	45	36	130	1400	11	58	47	125	1000	15	71	57	—	—	—	—	
	Ferry	130	1100	5	16	13	130	1000	10	23	19	130	800	16	32	26	130	600	23	42	34	125	300	34	56	45	—	—	—	—	
14200	Combat	135	1800	3	22	18	135	1800	5	37	30	130	1300	9	52	42	130	1100	13	66	53	125	700	19	86	69	—	—	—	—	
	Ferry	125	800	6	18	15	125	700	12	27	22	125	500	21	39	31	125	400	32	54	43	—	—	—	—	—	—	—	—		

NOTE: INCREASE ELAPSED CLIMBING TIME 6% FOR EACH 10 C (20 F) ABOVE 0 C (32 F) FREE AIR TEMPERATURE

FUEL INCLUDES WARM-UP AND TAKE OFF ALLOWANCE (10 U.S. GALS. 8 IMP. GAL.)

## LANDING DISTANCE (IN FEET) FOR 50° FLAP SETTING

GROSS WEIGHT (IN LBS.)	BEST I.A.S. APPROACH (KNOTS)	HARD DRY SURFACE						FIRM DRY SOD						WET OR SLIPPERY					
		AT SEA LEVEL		AT 3000 FT		AT 6000 FT		AT SEA LEVEL		AT 3000 FT		AT 6000 FT		AT SEA LEVEL		AT 3000 FT		AT 6000 FT	
		TO CLEAR 50' OB	GROUND ROLL	TO CLEAR 50' OB	GROUND ROLL	TO CLEAR 50' OB	GROUND ROLL	TO CLEAR 50' OB	GROUND ROLL	TO CLEAR 50' OB	GROUND ROLL	TO CLEAR 50' OB	GROUND ROLL	TO CLEAR 50' OB	GROUND ROLL	TO CLEAR 50' OB	GROUND ROLL	TO CLEAR 50' OB	GROUND ROLL
10000	90	1920	910	2080	990	2250	1090	2000	990	2180	1090	2360	1200	3110	1100	3380	9990	3670	3510
11000	95	2080	970	2280	1090	2480	1210	2140	1030	2390	1200	2610	1330	3520	1410	3710	9530	4030	3760

NOTE: FOR GROUND TEMPERATURES ABOVE 15 C (59 F) INCREASE APPROACH I.A.S. 10% AND ALLOW 20% INCREASE IN GROUND ROLL

### LEGEND Red figures have not been flight checked

I.A.S. Indicated air speed  
S.L. Sea level  
U.S. U.S. gallons  
Imp. Imperial gallons

REMARKS: Take-off and climb data include the effect of the drag increment of 1000 and 150 U.S. gal. (128 Imp. gal.) drop tank or 1000 lb. tank in the 14200 lb. condition. For the 14200 lb. condition, the effect of the drag increment for any combination of two units (bombs, tanks, fuel, and tank) is included.

Above performance is for 6501 A 0.13 foot 1-inch propeller

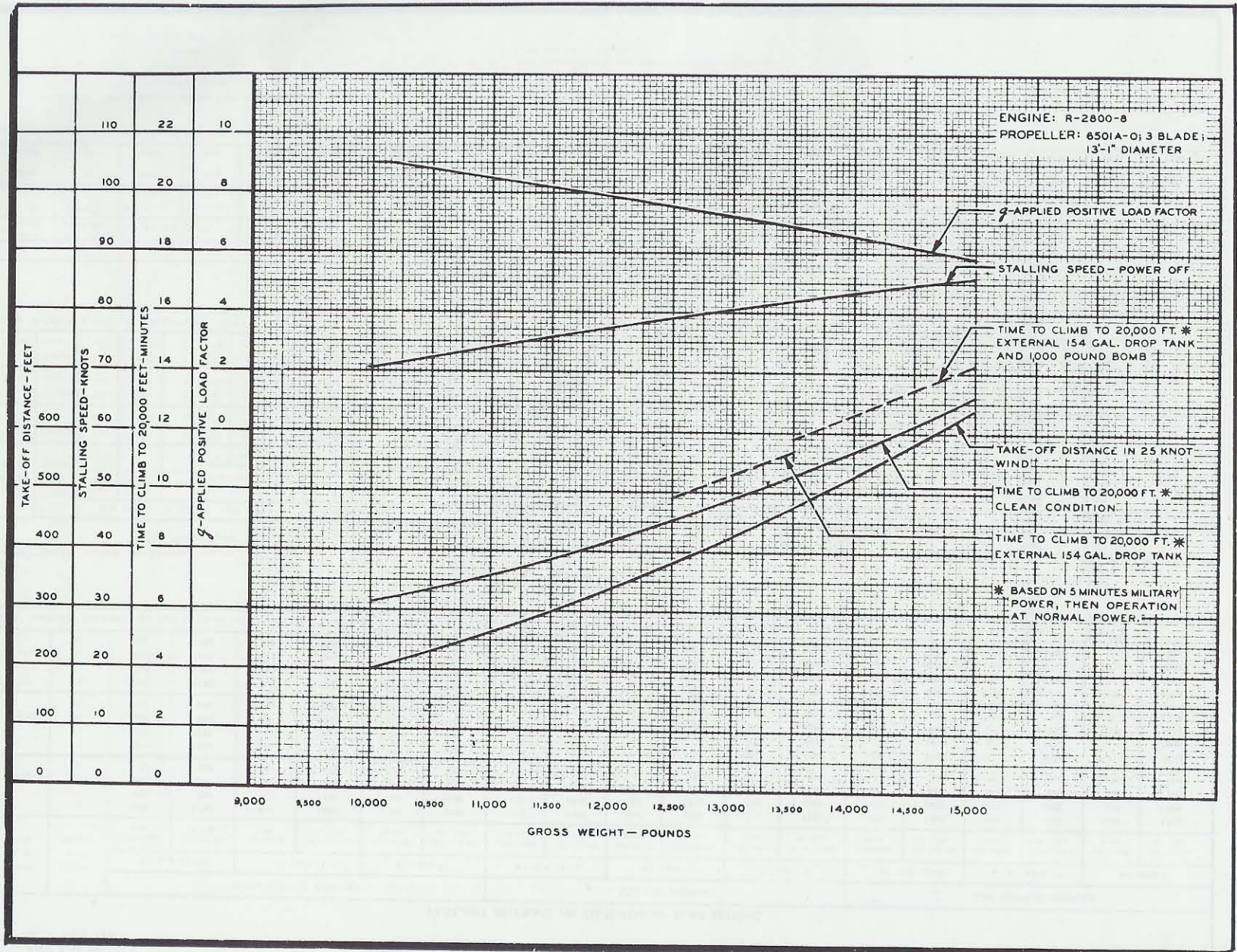

Variation of Performance with Weight — Plate I



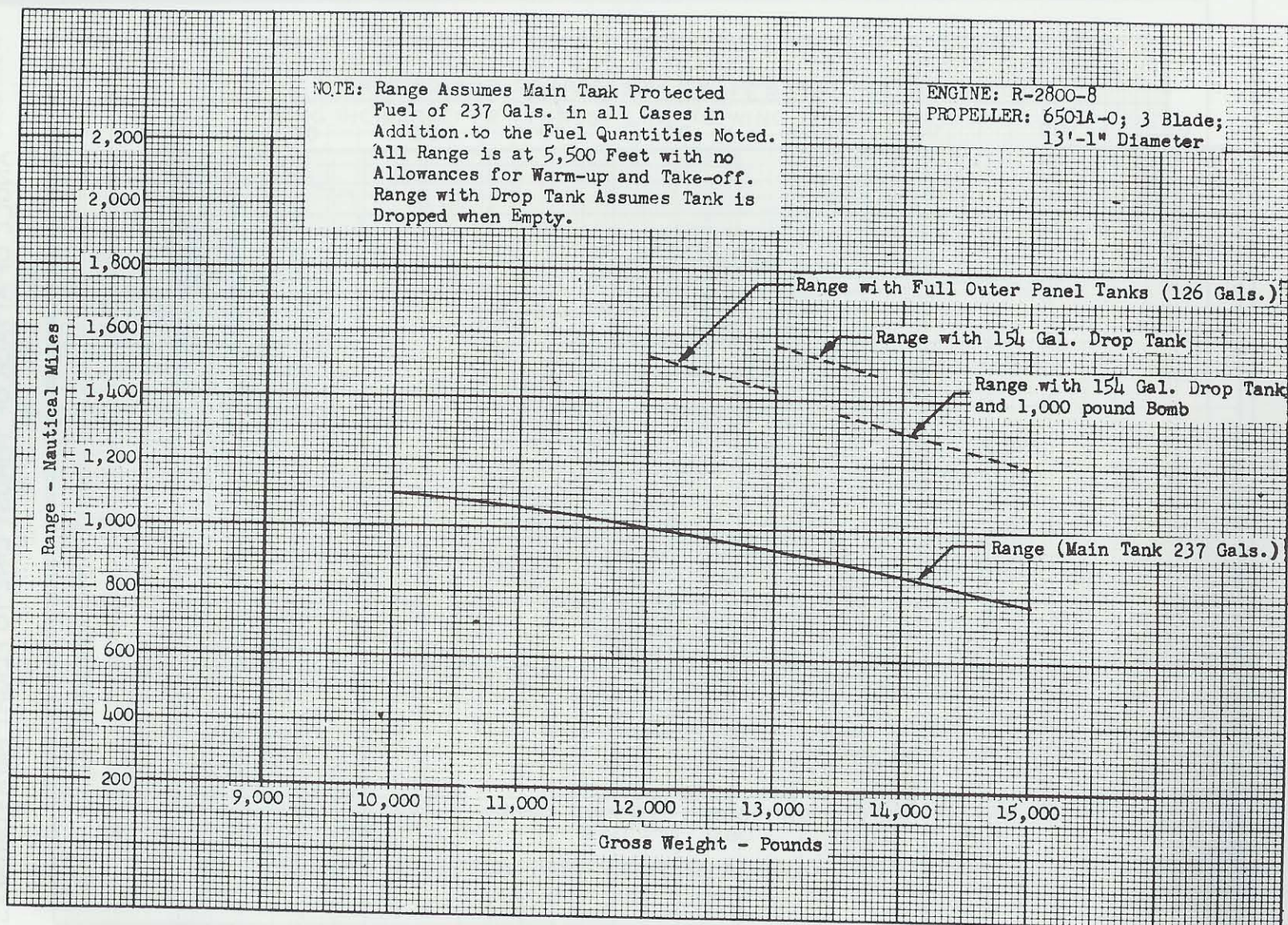

Variation of Performance with Weight — Plate II

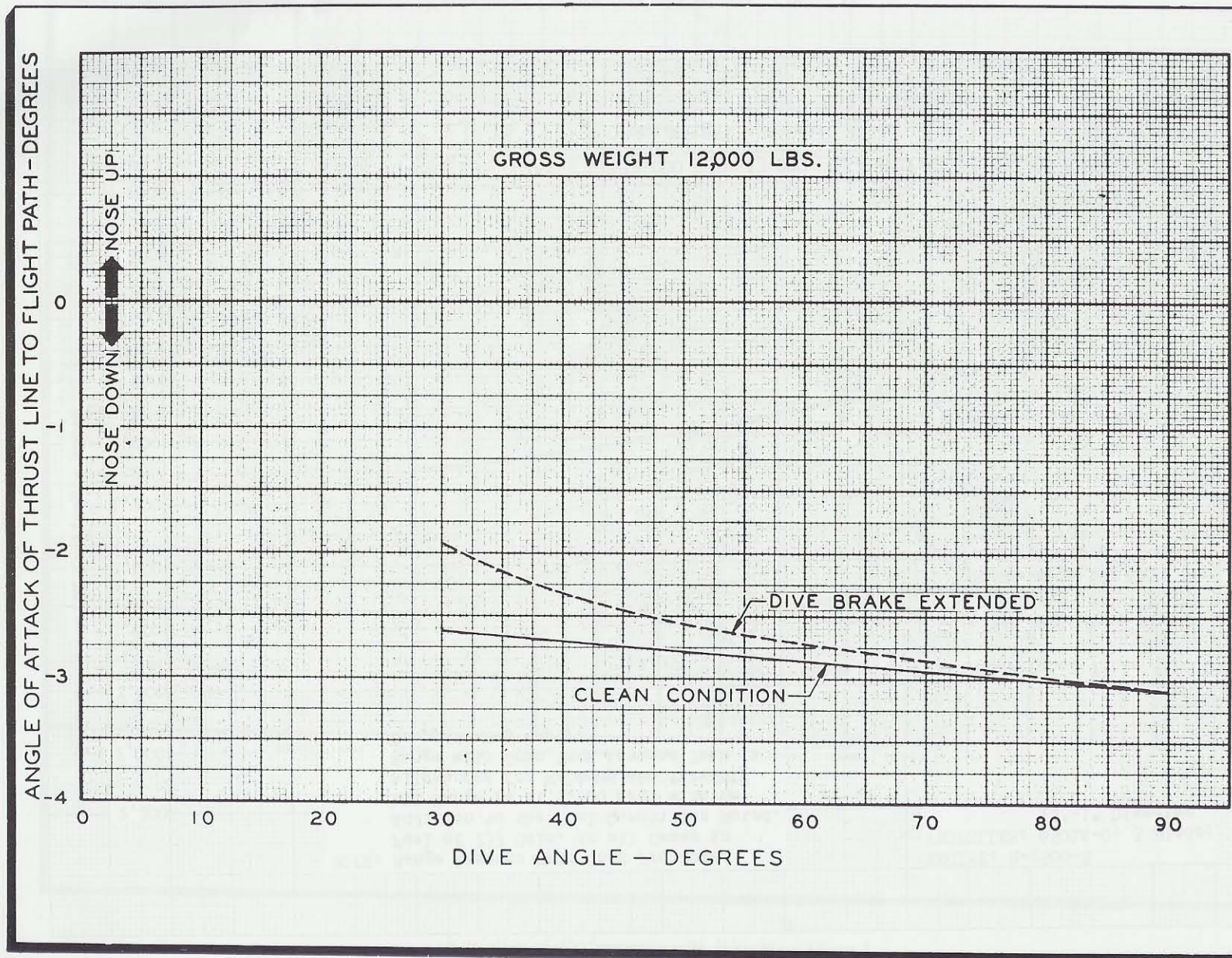

*Angle of Attack at Terminal Velocity vs. Dive Angle*

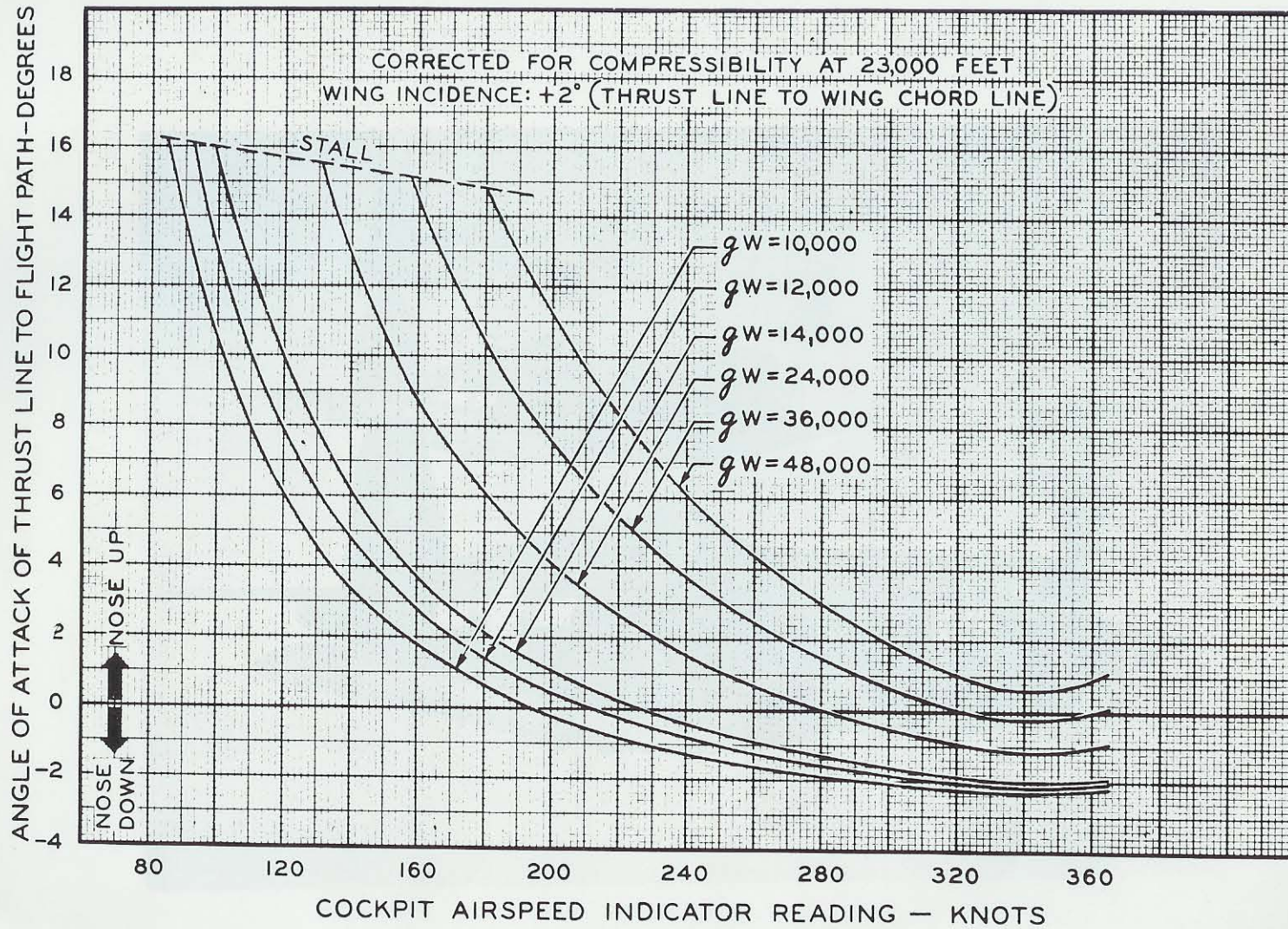

Angle of Attack vs. Cockpit Air Speed Indicator Reading

