

# FLIGHT HANDBOOK

USAF SERIES

# T-6G

AIRCRAFT

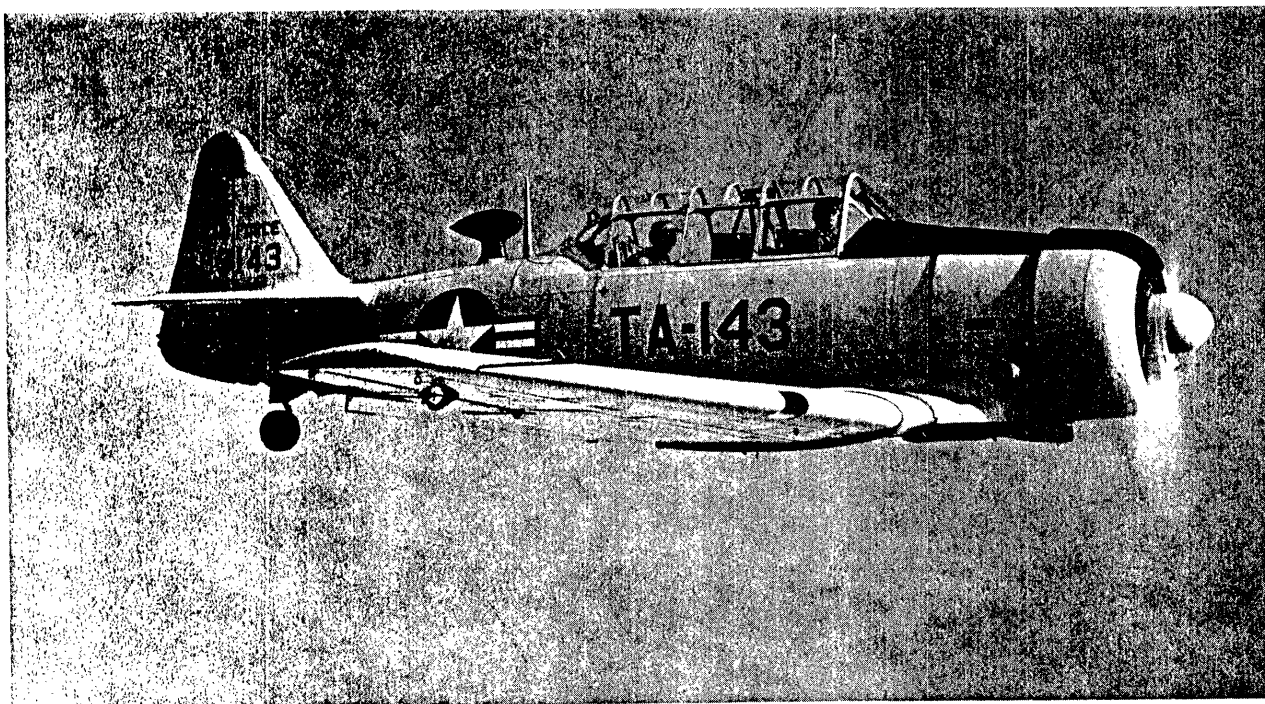

---

## REVISION NOTICE

**LATEST REVISED PAGES SUPERSEDE  
THE SAME PAGES OF PREVIOUS DATE**

Insert revised pages into basic  
publication. Destroy superseded pages.

---

PUBLISHED UNDER AUTHORITY OF THE SECRETARY OF THE  
AIR FORCE AND THE CHIEF OF THE BUREAU OF AERONAUTICS

**30 JUNE 1952**  
REVISED 25 AUGUST 1953

Reproduction for non-military use of the information or illustrations contained in this publication is not permitted without specific approval of the issuing service (BuAer or USAF). The policy for use of Classified Publications is established for the Air Force in AFR 205-1 and for the Navy in Navy Regulations, Article 1509.

**LIST OF REVISED PAGES ISSUED**

**INSERT LATEST REVISED PAGES. DESTROY SUPERSEDED PAGES.**

NOTE: The portion of the text affected by the current revision is indicated by a vertical line in the outer margins of the page.

| Page No. | Date of Latest Revision |
|----------|-------------------------|
| *Title   | 25 August 1953          |
| ii       | 30 June 1953            |
| 3        | 30 June 1953            |
| 8        | 30 June 1953            |
| 11       | 30 June 1953            |
| 12       | 30 June 1953            |
| 13       | 30 June 1953            |
| 15       | 30 June 1953            |
| 18       | 30 June 1953            |
| 21       | 30 June 1953            |
| 25       | 30 June 1953            |
| 33       | 30 January 1953         |
| 35       | 30 January 1953         |
| 36       | 30 January 1953         |
| 43       | 30 January 1953         |
| 45       | 30 January 1953         |
| 47       | 30 June 1953            |
| 48       | 30 June 1953            |
| 49       | 30 June 1953            |
| 50       | 30 June 1953            |
| 52       | 30 June 1953            |
| 53       | 30 June 1953            |
| 54       | 30 June 1953            |
| 56       | 30 June 1953            |
| 57       | 30 June 1953            |
| 63       | 30 June 1953            |
| 67       | 30 January 1953         |
| 68       | 30 January 1953         |
| 76       | 30 January 1953         |

\* The asterisk indicates pages revised, added or deleted by the current revision.

**ADDITIONAL COPIES OF THIS PUBLICATION MAY BE OBTAINED AS FOLLOWS:**

USAF ACTIVITIES.—In accordance with Technical Order No. 00-5-2.

NAVY ACTIVITIES.—Submit request to nearest supply point listed below, using form NavAer-140; NASD, Philadelphia, Pa.; NAS, Alameda, Calif.; NAS, Jacksonville, Fla.; NAS, Norfolk, Va.; NAS, San Diego, Calif.; NAS, Seattle, Wash.; ASD, NSC, Guam.

For listing of available material and details of distribution see Naval Aeronautics Publications Index NavAer 00-500.

Revised 25 August 1953

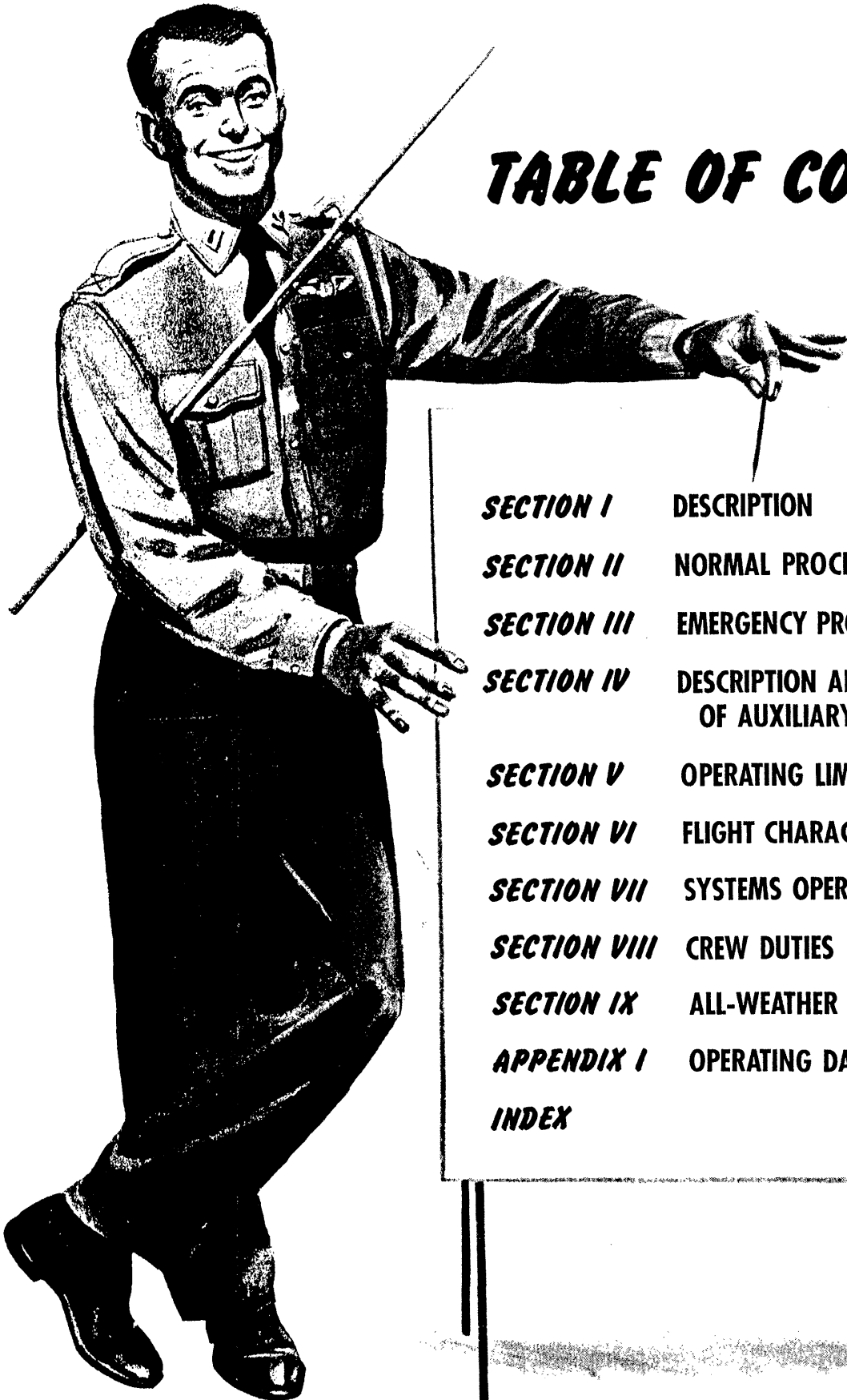

# TABLE OF CONTENTS

|                     |   |           |
|---------------------|---|-----------|
| <b>SECTION I</b>    | <b>DESCRIPTION</b>  | <b>1</b>  |
| <b>SECTION II</b>   | <b>NORMAL PROCEDURES</b>                                    | <b>27</b> |
| <b>SECTION III</b>  | <b>EMERGENCY PROCEDURES</b>                                 | <b>39</b> |
| <b>SECTION IV</b>   | <b>DESCRIPTION AND OPERATION<br/>OF AUXILIARY EQUIPMENT</b> | <b>47</b> |
| <b>SECTION V</b>    | <b>OPERATING LIMITATIONS</b>                                | <b>59</b> |
| <b>SECTION VI</b>   | <b>FLIGHT CHARACTERISTICS</b>                               | <b>65</b> |
| <b>SECTION VII</b>  | <b>SYSTEMS OPERATION</b>                                    | <b>71</b> |
| <b>SECTION VIII</b> | <b>CREW DUTIES</b> <i>(Not Applicable)</i>                  |           |
| <b>SECTION IX</b>   | <b>ALL-WEATHER OPERATION</b>                                | <b>75</b> |
| <b>APPENDIX I</b>   | <b>OPERATING DATA CHARTS</b>                                | <b>83</b> |
| <b>INDEX</b>        |   | <b>95</b> |

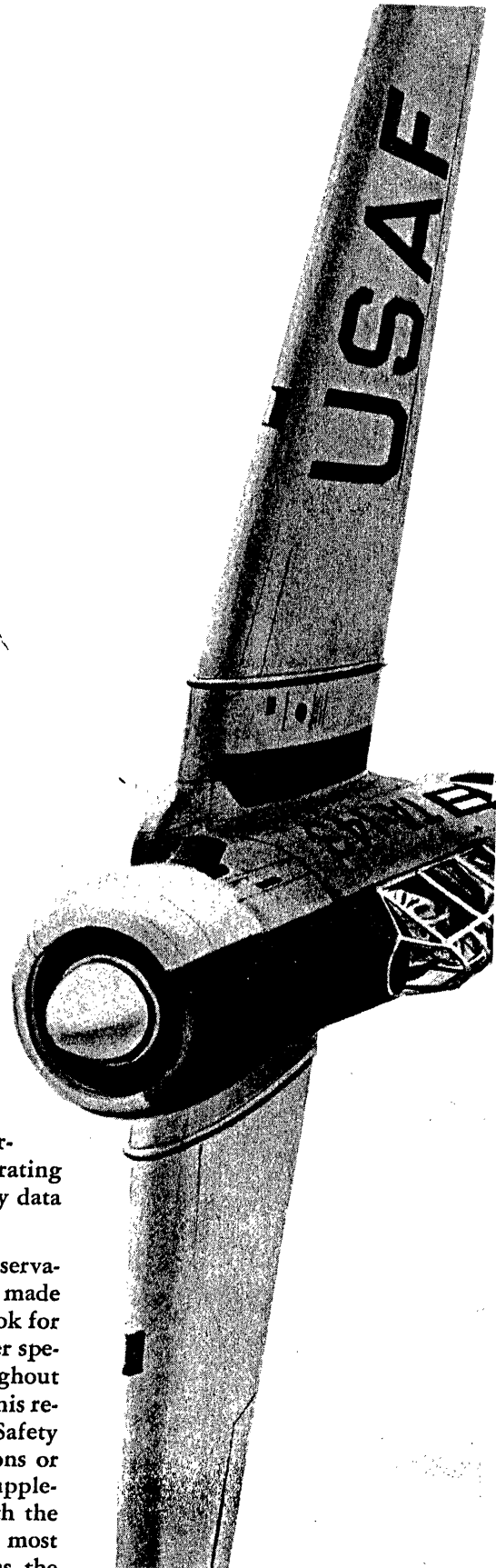
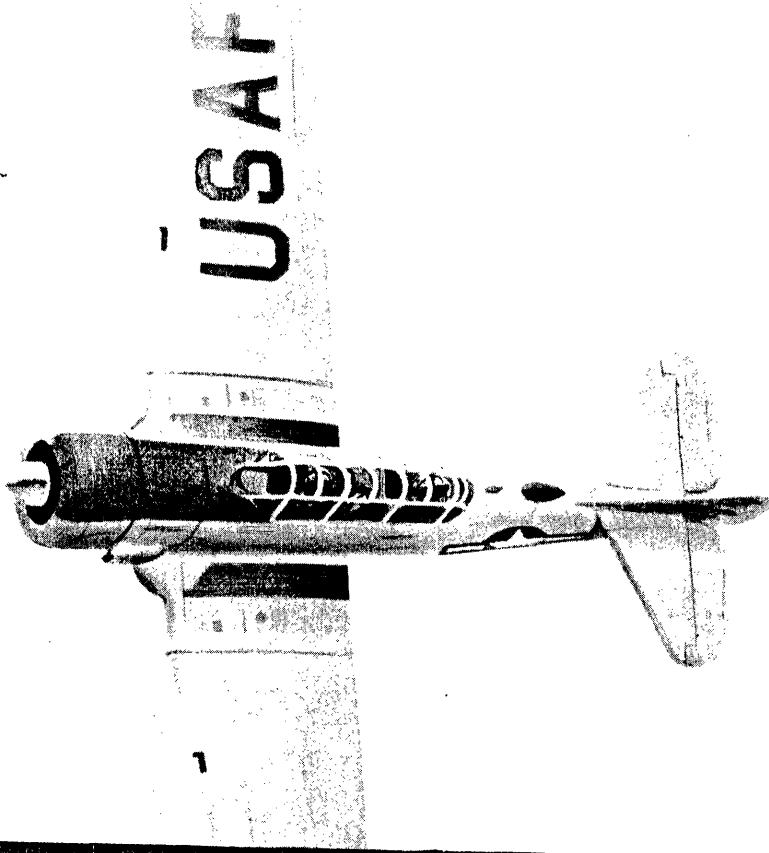

## IMPORTANT

*In order to gain the maximum benefits from this handbook, it is imperative that you read this page carefully.*

This handbook contains all information necessary for safe and efficient operation of the T-6G Airplane. These instructions are not intended to teach the basic principles of flight, but are designed to provide you with a general knowledge of the airplane, its flight characteristics, and specific normal and emergency procedures to be used in operating the airplane and its related equipment. Your comments concerning any data to be added or suggested changes are invited.

These instructions are based on engineering reports and on flight observations by Air Force and manufacturer's test pilots. Every effort has been made to make the handbook easy to read and assimilate. Read the complete book for an over-all picture of the airplane; use it as a reference manual to answer specific questions. The information in this handbook is kept current throughout the life of the airplane by frequent revisions. Since the incorporation of this revision material takes time, it is imperative that you stay abreast of the Safety of Flight Supplements, which frequently cover critical flight restrictions or new operating techniques not yet incorporated in the handbook. These supplements use the same publication number assigned to the handbook, with the addition of a letter such as "C," "D," etc. This system provides the most expeditious method of getting information to you until such time as the handbook is revised.



The handbook is divided into nine sections and an appendix as follows:

- Section I, DESCRIPTION—a detailed picture of the airplane, its equipment, systems, and all controls that are essential to flight. Also included is a description of all emergency equipment that is not part of the auxiliary equipment.
- Section II, NORMAL PROCEDURES—operating instructions arranged in proper sequence from the time the airplane is approached by the pilot until it is left parked on the ramp after completion of a routine flight.
- Section III, EMERGENCY PROCEDURES—concise instructions to be followed in meeting any emergency (except those in connection with auxiliary equipment) that could reasonably be expected.
- Section IV, DESCRIPTION AND OPERATION OF AUXILIARY EQUIPMENT—description of, and normal and emergency operating instructions for, all equipment not essential for flying the airplane, such as heating, ventilating, communications, lighting, and armament.
- Section V, OPERATING LIMITATIONS—covers all important limitations that must be observed during normal operation. Some limitations that are covered along with specialized phases of operation are not included in this section.
- Section VI, FLIGHT CHARACTERISTICS—advantageous as well as any dangerous flight characteristics are summarized. Complete descriptions of stalls, spins, dives, and recovery techniques are emphasized to cover all phases of basic maneuvers.
- Section VII, SYSTEMS OPERATION—a discussion of the operation and characteristics of the various systems of the airplane as they are affected by normal flight conditions such as varying altitude and air temperature. Emphasis has been given to those special problems which must be considered in the operation of a system.
- Section VIII, CREW DUTIES—omitted as not applicable to this airplane.
- Section IX, ALL-WEATHER OPERATION—proper technique and procedure to follow under various weather conditions. This section is designed to serve as a supplement to normal operating procedures and provides all necessary instructions to be followed, in conjunction with the procedures contained in Section II, for satisfactory all-weather operation.
- Appendix I, OPERATING DATA CHARTS—all operating data charts for efficient preflight and in-flight mission planning. Complete data is supplied for obtaining best climb speeds, necessary cruise control information, and take-off and landing distances at various field altitudes.

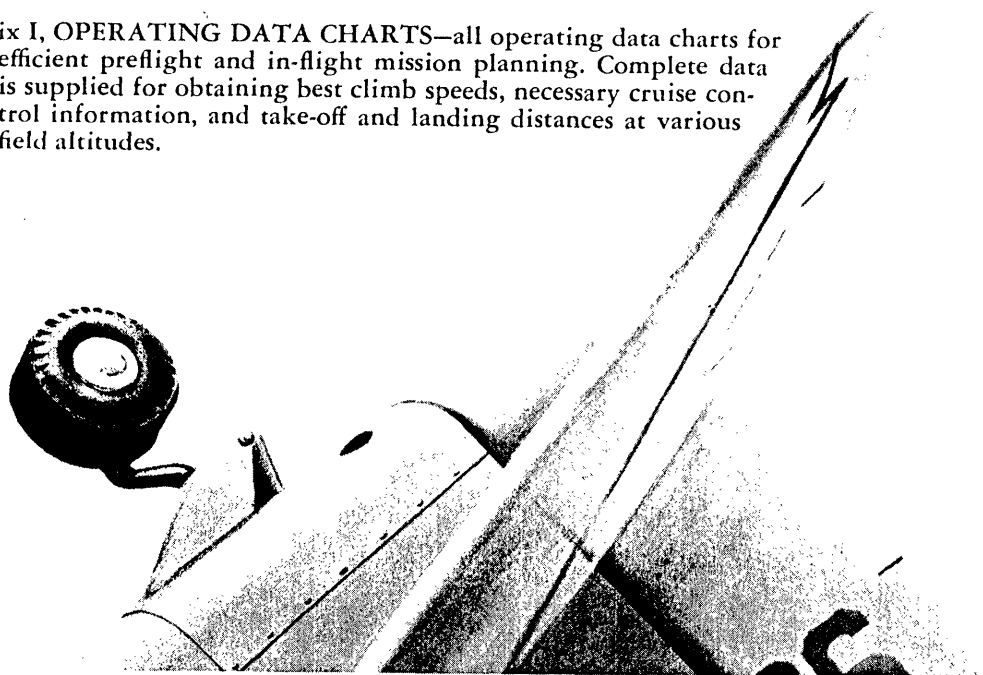
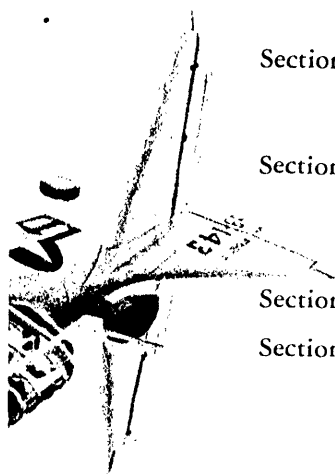

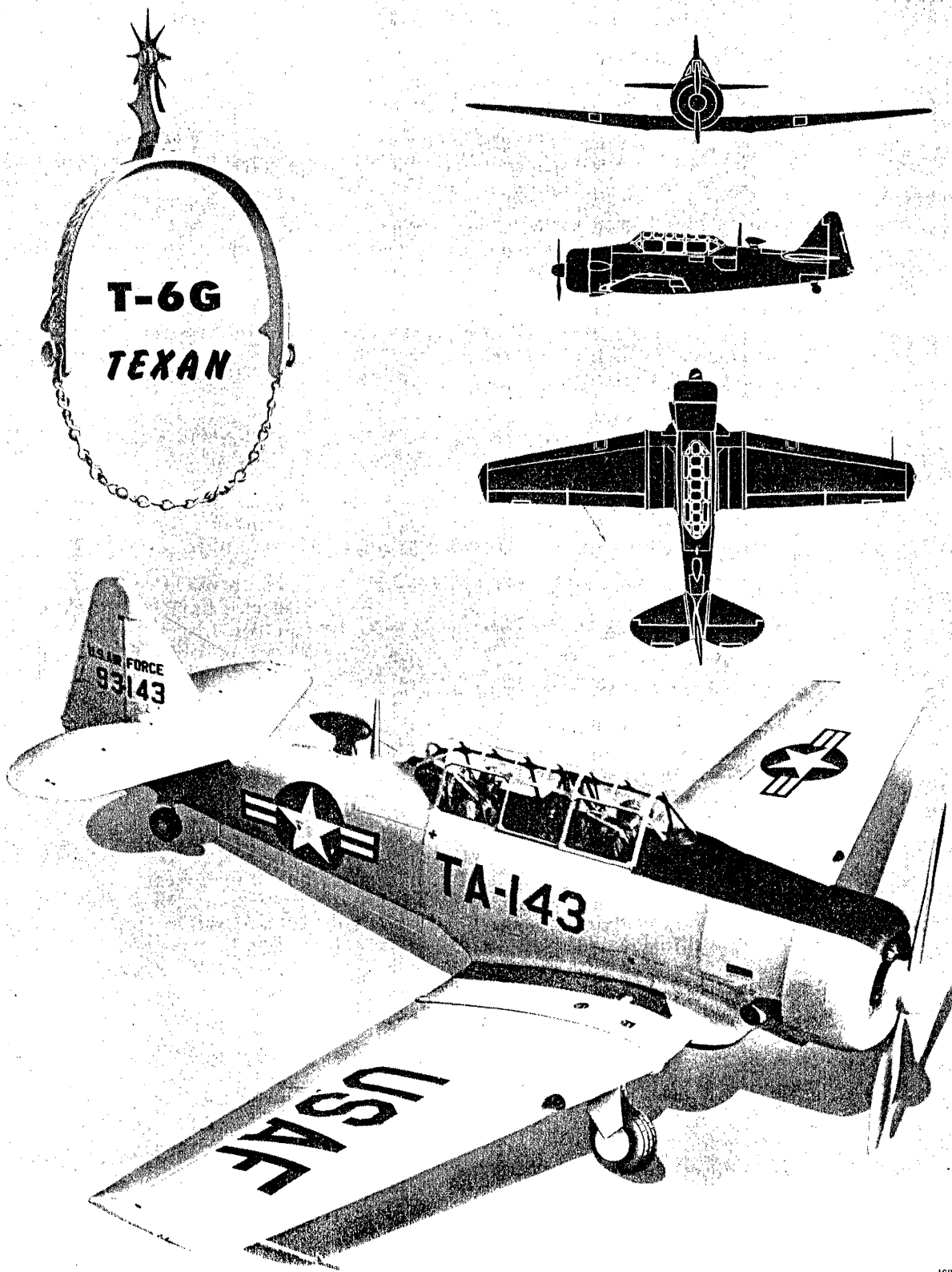

168-00-1074A

Figure 1-1

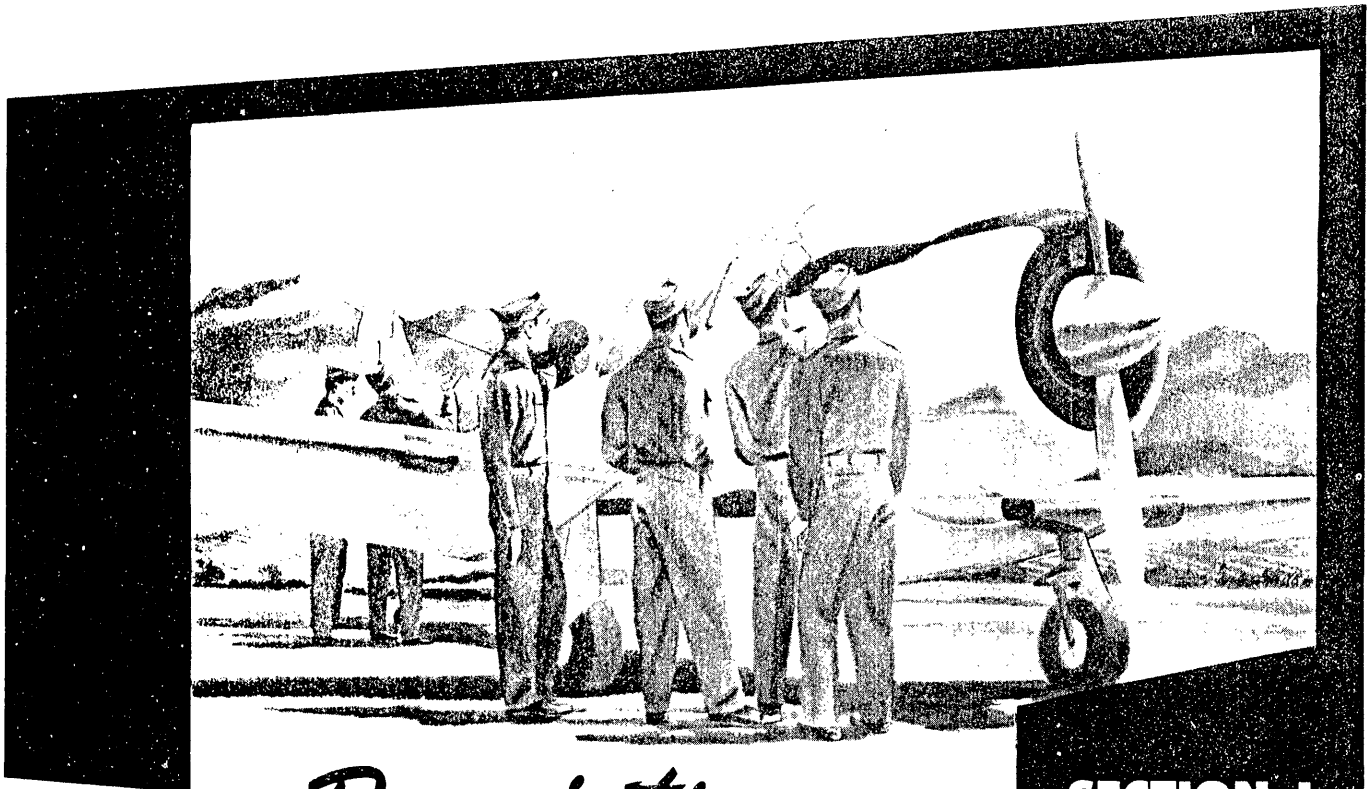

## Description

### SECTION I

#### AIRPLANE.

Few airplanes in this country are more familiar to military pilots than the T-6. In addition to training our own Air Force, Navy, and Marine pilots in precision flying, the T-6 is used in the air forces of a majority of the United Nations. More than 15,000 of the T-6 Series Airplanes have been built, and most of them are still in active service.

The T-6 (formerly the AT-6), which is designated the SNJ by the Navy and is known by a host of other names in the air forces of the world, is an outgrowth of the NA-16, the prototype of the entire series of famed training planes. The NA-16 was the first airplane designed and built by North American Aviation. It took off from Logan Field at Dundalk, Maryland, in 1934, after being designed and built in less than 9 weeks.

The T-6G, the seventh in the T-6 series, is essentially the same airplane as the original T-6. Its career began in 1940 when the first model rolled off the North American assembly lines. Known as the "Texan," it helped teach thousands of American and Allied pilots their flying ABC's during World War II. Today, the T-6 is still in the forefront in the training of pilots to defend America. Its flying, maintenance, and training qualities have proved so impressive that, even these many years after it was first built, the T-6 is still teaching men throughout the world to fly a military airplane. The airplane

is a two-place, dual-controlled, single-engine trainer. (See figure 1-2.) Solo flight is permitted only from the front cockpit because of restricted visibility from the rear seat and inadequate controls in the rear cockpit. On training flights, the student uses the front cockpit while the instructor occupies the rear, except for instrument training when the student occupies the rear seat. The airplane incorporates a steerable tail wheel.

#### AIRPLANE DIMENSIONS.

Approximate over-all dimensions of the airplane are:

|   |           |
|---|-----------|
| Length .....                                | 29.0 feet |
| Wing span .....                             | 42.0 feet |
| Height .....                                | 12.0 feet |
| (to top of rudder in level flight attitude) |           |

#### ENGINE.

The airplane is powered by a 600-horsepower (Take-off Power), nine-cylinder Pratt & Whitney radial engine, Model R-1340-AN-1. The engine is equipped with an updraft float-type carburetor and a combination inertia, direct-cranking starter.

#### ENGINE CONTROLS.

Throttle and mixture controls are located on the throttle quadrant on the left side of each cockpit. A friction lock (8, figure 1-17), on the inboard face of the quadrant in the front cockpit only, is rotated to increase friction of the throttle, mixture, and propeller controls. Carburetor

# GENERAL ARRANGEMENT

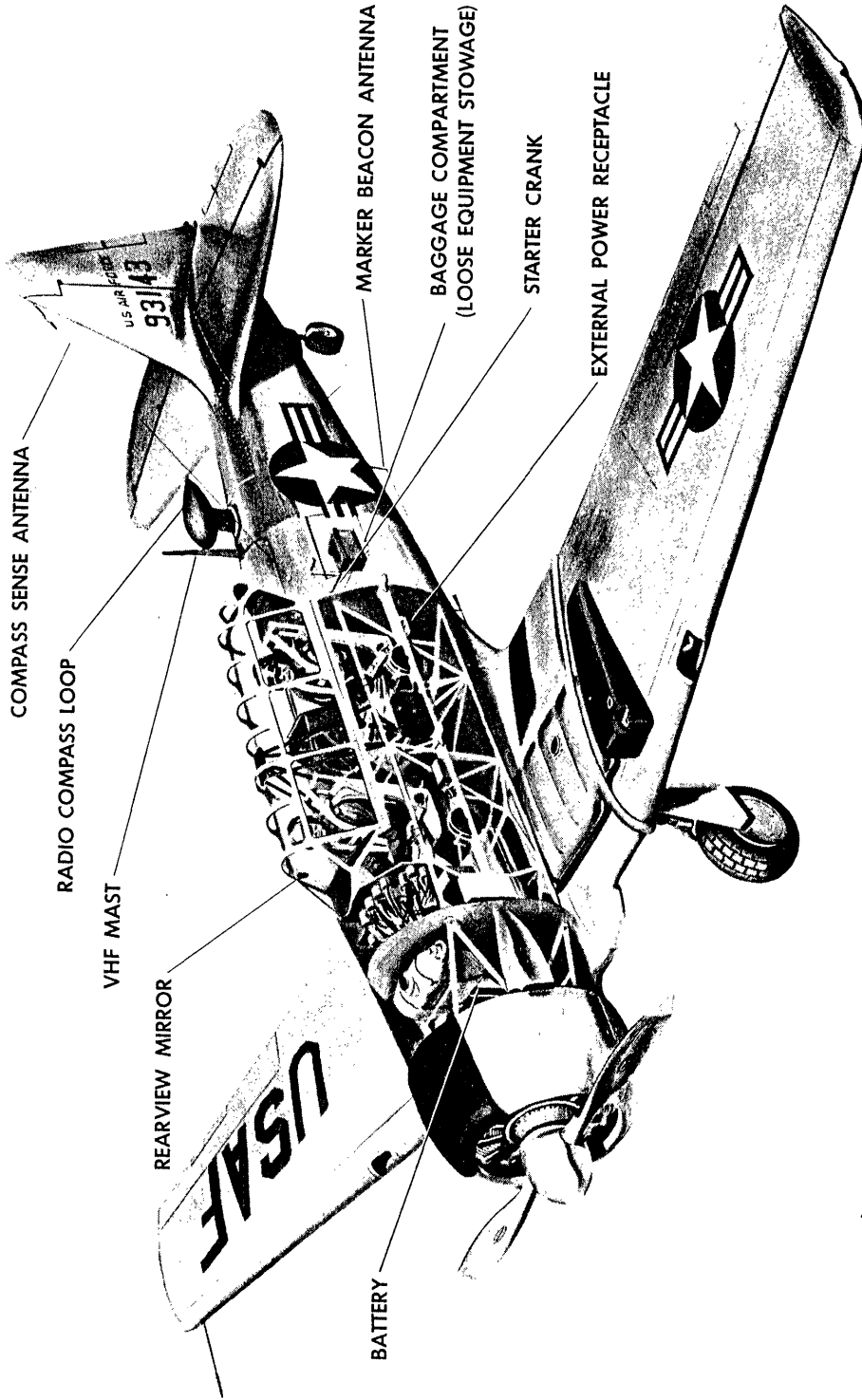

168-00-1075

Figure 1-2

mixture temperature is controlled by a carburetor air control in the front cockpit.

**THROTTLE.** A throttle (12, figure 1-17; 12, figure 1-23) is located on the quadrant on the left side of each cockpit. A take-off stop is provided in the quadrant so that the pilot can feel when he has reached Take-off Power at sea level. (See figure 1-4.) The throttle in the front cockpit can be pushed through the stop to obtain full throttle travel when additional power is needed at altitudes above sea level. When the throttle is retarded, the landing gear warning horn will blow if the landing gear is not locked in the down position. Incorporated in the throttle grip is a radio transmitter microphone control button (14, figure 1-17; 13, figure 1-23).

**MIXTURE CONTROL.** The mixture control (10, figure 1-17; 9, figure 1-23) on the throttle quadrant in each

cockpit enables the pilot to control the fuel-air mixture to the engine to obtain efficient engine operation and maximum fuel economy. Positions on the quadrant are RICH (full forward), LEAN (aft), and IDLE CUT-OFF (full aft). Any position between RICH and LEAN is in the manual leaning range. (See figure 1-4.) The front cockpit mixture control is equipped with a spring-loaded lock and ratchet. When the mixture control in either cockpit is moved forward, the lock is automatically released. However, before the mixture control can be moved aft toward LEAN, the lock must be released by pressing forward on the lock lever. The IDLE CUT-OFF position shuts off all fuel flow at the carburetor to stop the engine.

**CARBURETOR AIR CONTROL.** The carburetor air control handle (17, figure 1-17) is located on the left console of the front cockpit. When the control is at COLD, ram air is admitted to the carburetor through the ram-air (filtered) inlet on the left side of the engine cowl. As the control is moved toward the HOT position, it gradually closes the ram-air inlet while opening a duct that allows warm air from inside a muff surrounding the exhaust collector ring to mix with the cold ram air before being delivered to the carburetor. When the control is at the full HOT position, the ram-air inlet is fully closed and hot air only is drawn into the carburetor. (See figure 1-5.) A carburetor mixture temperature gage (11, figure 1-15; 17, figure 1-21), mounted on the instrument panel in the front and rear cockpits, indicates the temperature of the fuel-air mixture as it enters the engine.

WITH BOTH PILOTS AND FULL FUEL TANKS



**NORMAL GROSS**

**5625 lb**

|                                 | <b>T-6G</b>   | <b>T-6D</b>   |
|---------------------------------|---|---|
| <b>FUEL CAPACITY</b>            | 140 US. GALLONS (NO PROVISIONS FOR RESERVE FUEL SUPPLY)   | 110 US. GALLONS (FUEL TANK STANDPIPE PROVIDED FOR RESERVE FUEL SUPPLY)                                  |
| <b>ELECTRONICS</b>              | SCR-522A, CONTRACTOR-DESIGNED INTERPHONE (PART OF SCR-522A)<br>COMPLETE PROVISIONS FOR AN/ARN-5A AND RC-103A<br>AN/ARC-3 VHF COMMAND RADIO*<br>AN/ARN-6 RADIO COMPASS†<br>USAF COMBAT INTERPHONE†<br>AN/ARN-12 MARKER BEACON†<br>PROVISIONS FOR AN/ARA-26 EMERGENCY KEYS† | AN/ARC-3, AN/AIC-2, AN/ARN-7, RC-193A.  |
| <b>REAR COCKPIT INSTRUMENTS</b> | FULL COMPLEMENT OF INSTRUMENTS IDENTICAL TO THOSE IN FRONT COCKPIT, EXCEPT HYDRAULIC PRESSURE GAGE.   | FLIGHT INSTRUMENTS ONLY ARE IDENTICAL TO THOSE IN FRONT COCKPIT.  |
| <b>ARMAMENT</b>                 | NONE  | TWO FIXED FORWARD-FIRING .30-CALIBER GUNS, BOMBING EQUIPMENT, ONE FLEXIBLE .30-CALIBER GUN (PROVISIONS) |
| <b>HYDRAULIC SYSTEM</b>         | ACTUATED AUTOMATICALLY BY GEAR OR FLAP CONTROL HANDLE   | ACTUATED BY POWER CONTROL LEVER IN EITHER COCKPIT   |
|                                 | *AIRPLANES AF51-14314 THROUGH -14358, -14684 THROUGH -15137, AND -17354 AND SUBSEQUENT  |   |
|                                 | †AIRPLANES AF51-14314 THROUGH -15137 AND -17354 AND SUBSEQUENT  | 168-00-1140A  |

Figure 1-3. Main Differences Table

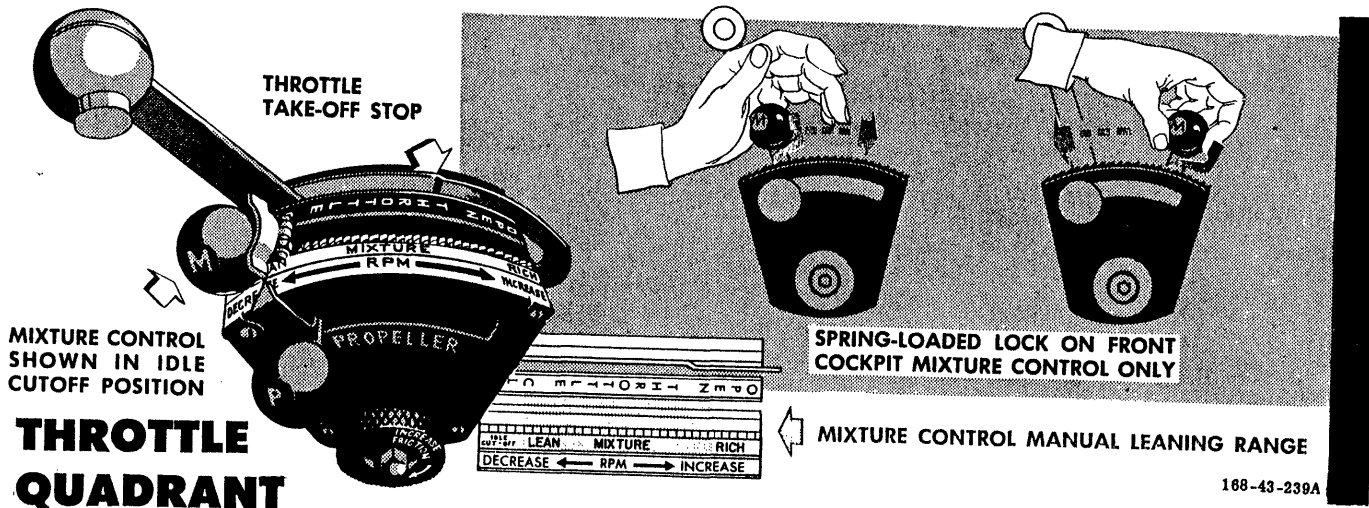

# THROTTLE QUADRANT

Figure 1-4

168-43-239A

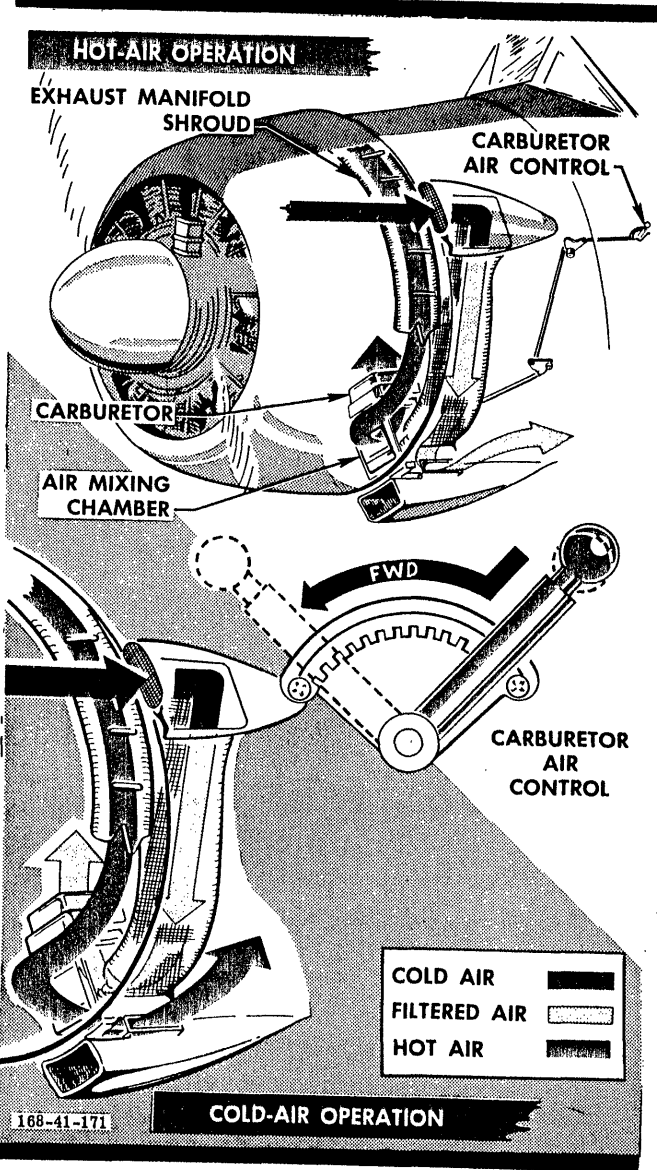

168-41-171

Figure 1-5. Air Induction System

**IGNITION SWITCH.** A standard ignition switch (26, figure 1-15; 28, figure 1-21), is located on the left side of the instrument panel in each cockpit. Switch positions are OFF, L, R, and BOTH. The L and R positions are provided to check engine operation on the left or right magneto individually.

**STARTER SWITCH PEDAL.** A starter switch pedal (5, figure 1-20), located between the rudder pedals in the front cockpit, provides control of the starter. Originally the airplane was delivered with the starter wired to be energized by the heel of the pedal (marked "PUSH TO ENERGIZE") and engaged (after coming up to speed) by the toe of the pedal (marked "PUSH TO ENGAGE"). However, the starter has been wired for direct cranking, so that pressing either the heel or the toe of the pedal will both energize and engage the starter to the engine. Power for energizing the starter can be derived from the airplane battery, although an external power source should be connected for this purpose, whenever possible, to conserve battery life.

**ENGINE PRIMER.** The engine priming system is controlled by a push-pull hand primer (3, figure 1-20), located below the instrument panel in the front cockpit. The primer pumps fuel from an outlet in the hand fuel pump directly into the five top cylinders to aid in starting. When not in use, the pump should be pushed in and turned to the right to the locked-closed position.

**ENGINE CRANK.** An engine crank, stowed in the baggage compartment, is provided for emergency use to hand-crank the starter when electrical power is not available.

### ENGINE INDICATORS.

A complete set of engine instruments is mounted in the front and rear cockpits. The oil pressure, fuel pressure, and manifold pressure gages indicate pressure directly from the engine. When the engine is inoperative, the manifold pressure gage reading should correspond to

barometric pressure. The tachometer and cylinder head temperature gage readings are self-generated and therefore do not require power from the electrical system of the airplane. Oil temperature and carburetor mixture temperature gages, however, depend upon the 28-volt d-c system.

#### MANIFOLD PRESSURE GAGE DRAIN VALVE.

A manifold pressure gage drain valve is provided to clear the manifold pressure instrument lines of moisture and vapors so that accurate indications can be obtained on the gage. The drain valve is opened by turning a handle (15, figure 1-17), located forward of the front cockpit throttle. The differential between atmospheric pressure and manifold pressure enables flow through the instrument lines to clear them of vapors when the drain valve is opened. The valve should be opened only when the engine is operating below 30 in. Hg manifold pressure so that the vapors will be carried into the engine instead of toward the gage. Remember that the greatest differential between atmospheric and manifold pressures exists at low power.

#### PROPELLER.

The engine drives a two-bladed, constant-speed, all-metal propeller. A propeller control is provided to select the engine rpm to be held constant. Either square-tip or round-tip blades are utilized on this airplane. For information concerning propeller operation, refer to Section VII and see figure 7-1. A spinner is installed to the propeller hub.

#### PROPELLER CONTROL.

Engine rpm is determined by the setting of a propeller control (9, figure 1-17; 11, figure 1-23), located on the throttle quadrant in each cockpit. Positioning of the propeller control mechanically adjusts the setting of a propeller governor mounted on the nose section of the

engine. The propeller governor maintains the selected rpm, regardless of varying air loads or flight attitudes. The propeller control may be placed at any intermediate position between DECREASE and INCREASE rpm, depending upon the engine rpm desired. To enable maximum rated horsepower to be obtained for take-off, the propeller control is positioned to full INCREASE rpm. During a landing, the propeller control is set to obtain 2000 rpm to ensure immediate availability of power in case a go-around becomes necessary.

#### OIL SYSTEM.

Oil for engine lubrication is supplied from a 10.2-gallon tank. See figure 1-27 for oil specification and grade. Lubrication is accomplished by a pressure system with a dry sump and scavenge pump return. Oil flows from the tank to the engine pressure pump, which forces it through the engine, and is pumped back to the tank by the scavenge pump either directly or through the oil cooler, depending upon the temperature of the oil. A thermostatic valve in the oil cooler regulates the oil temperature by automatically controlling the flow of oil through the cooler. A surge valve is also provided in the by-pass line to enable oil to by-pass the cooler and prevent flow stoppage in case the oil congeals in the cooler.

#### OIL DILUTION SWITCH.

An oil dilution system is provided for diluting the oil with gasoline before engine shutdown whenever a cold-weather start is anticipated. The oil dilution switch (8, figure 1-18; 4, figure 1-19), located on the right console in the front cockpit, is spring-loaded to the OFF position and must be held ON to dilute the oil. When the switch is held in the ON position, fuel from the carburetor (under pressure) is allowed to enter the oil line to the engine to lower the viscosity of the oil.

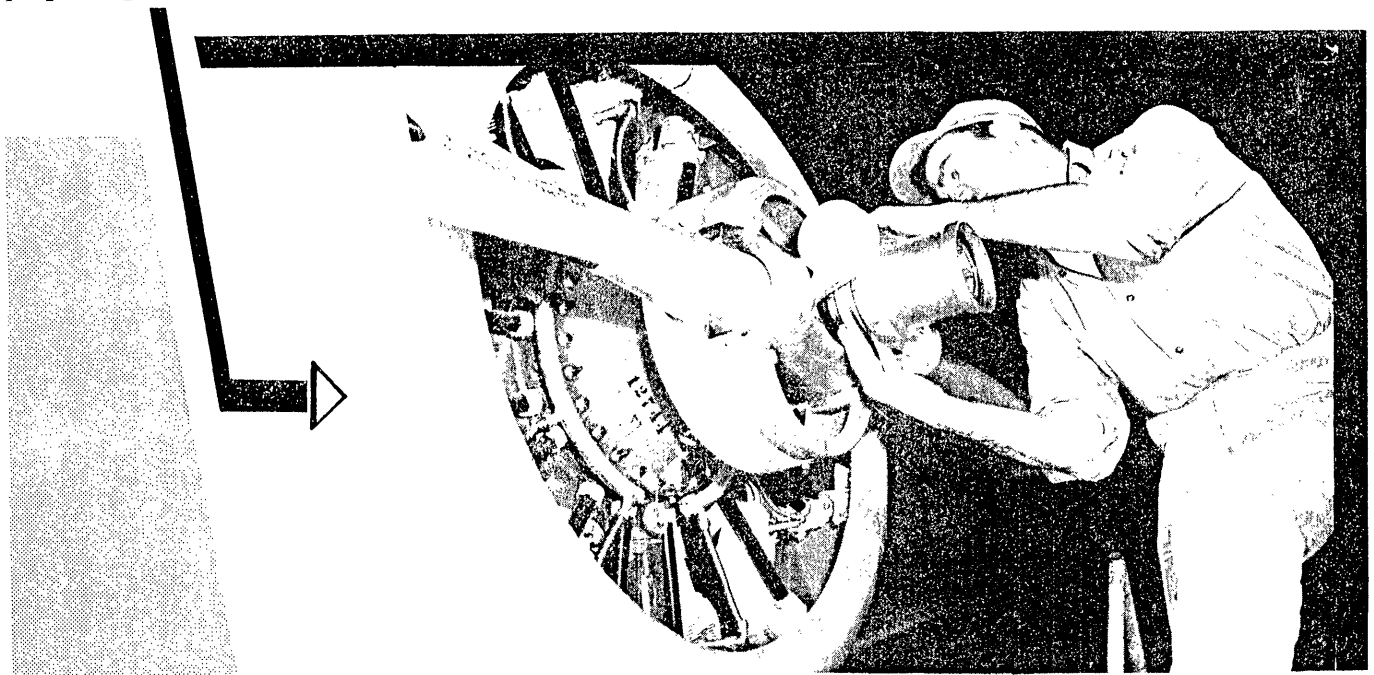



# FUEL SYSTEM CONTROLS

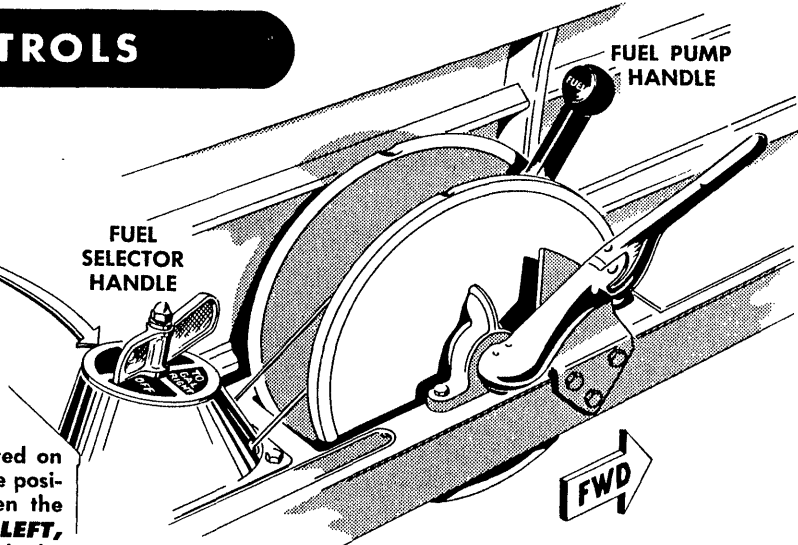

Both interconnected fuel selector handles are located on the left console of each cockpit. Each selector handle position has a detent to provide a distinct stop. When the selector is at either **70 GAL RIGHT** or **70 GAL LEFT**, all the fuel in the respective tank will be consumed. The **OFF** position shuts off all fuel flow.

A hand fuel pump, operated by interconnected handles, one in each cockpit, is provided to maintain fuel pressure if the engine-driven fuel pump fails.

168-48-1276

Figure 1-6

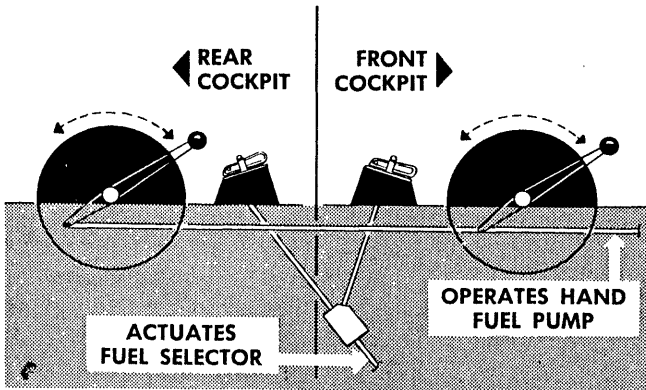

## FUEL SYSTEM INDICATORS.

**FUEL QUANTITY GAGES.** A float-type fuel quantity gage (figure 1-7) is located on each side of the pilot's seat in the front cockpit. The gages are visible from the rear cockpit seat, with approximately a 5-gallon increase because of parallax error. The fuel gages are not sufficiently accurate for exact readings; therefore, the values should be regarded as approximate.

**FUEL PRESSURE GAGE.** Fuel pressure is indicated on the engine gage unit (16, figure 1-15; 22, figure 1-21). The fuel pressure gage is the direct-reading type and indicates fuel pressure in the carburetor.

## FUEL SYSTEM.

The fuel system (figure 1-8) incorporates two all-metal fuel cells, which are located in the center section of the wing, and one bladder-type cell, installed in each outer wing panel. See figure 1-9 for fuel quantity data. Each tank sump is constructed so as to trap fuel around the tank outlets during inverted-flight maneuvers. An engine-driven fuel pump supplies fuel under pressure to the carburetor. If the engine-driven pump fails, sufficient fuel pressure can be supplied to the carburetor by means of a hand fuel pump to permit full-power engine operation. Fuel flow by gravity is available only to the fuel selector valve and hand fuel pump. See figure 1-27 for fuel grade and specification.

## FUEL SYSTEM CONTROLS.

See figure 1-6.

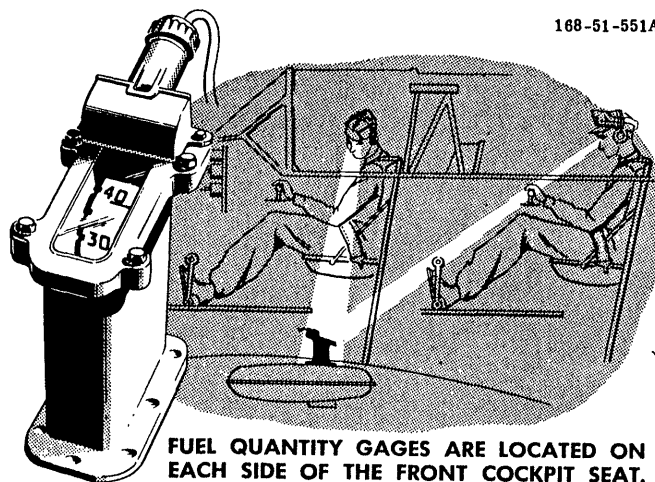

168-51-551A





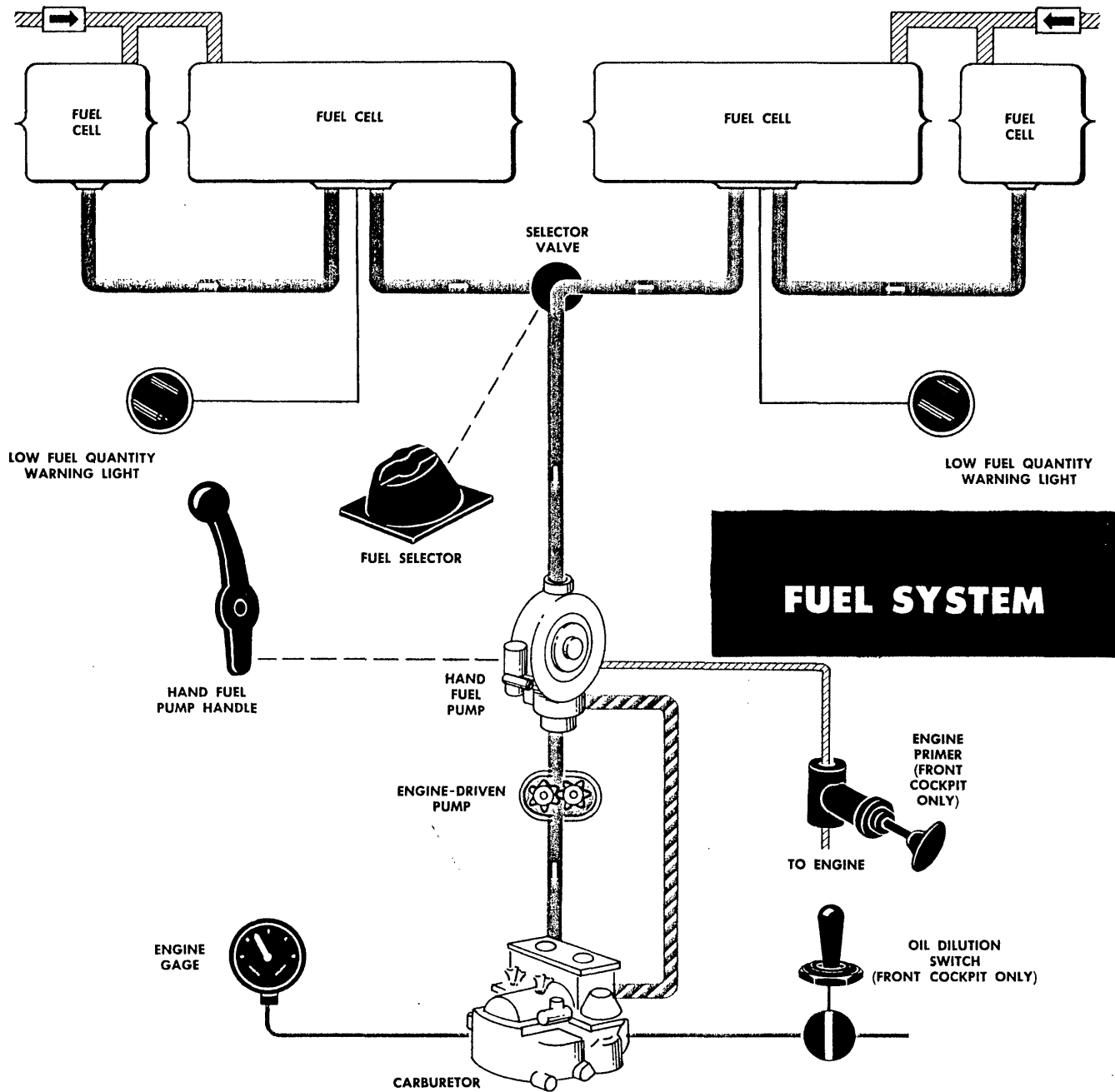

FUEL QUANTITY GAGES ARE LOCATED ON EACH SIDE OF THE FRONT COCKPIT SEAT.

# FUEL QUANTITY GAGES

Figure 1-7





- |   |                |   |                       |   |             |
|---|----------------|---|-----------------------|---|-------------|
|  | FUEL LINES     |  | CHECK VALVE           |  | PRIMER LINE |
|  | EMERGENCY LINE |  | ELECTRICAL CONNECTION |  | TANK VENT   |
|   |                |  | MECHANICAL CONNECTION |   |             |

**NOTE:** CONTROLS AND INDICATORS TYPICAL FOR FRONT AND REAR COCKPITS, EXCEPT AS NOTED.

168-48-1251

Figure 1-8

**LOW FUEL QUANTITY WARNING LIGHTS.** The low fuel quantity warning lights (1, 8, figure 1-15; 6, 14, figure 1-21), one each for left and right tank, are located on the left and right sides of each instrument panel. The lights illuminate when the fuel quantity in the respective tank drops to approximately 10 to 12 gallons. The lights can be checked by manually depressing (push-to-test) the desired light.

**Note**

Although this warning system informs the pilot that only 10 to 12 gallons of fuel remains in the related tanks, during banking maneuvers it is possible, because of tank baffle and flapper valve design, to "stuff" fuel into the cell enclosure from which fuel quantity warning is determined. Therefore, when the light illuminates, 6 to 8 gallons of fuel is the maximum that should be relied upon in the related tank.

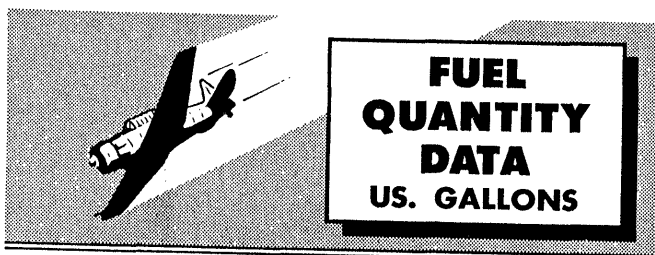

**NOTE:** Multiply gallons by 6.0 to obtain pounds gasoline (MIL-F-5572). Estimated data shown in red. 168-48-1250A

Figure 1-9

**ELECTRICAL POWER SUPPLY SYSTEM.**

Electrical power is supplied by a 50-ampere, engine-driven generator through a 28-volt, direct-current system. (See figure 1-10.)

A 24-volt battery serves as a stand-by power source for use when the generator is inoperative or not supplying sufficient voltage. A reverse-current relay is incorporated to automatically control the generator. The gen-

erator "cuts in" at approximately 1250 rpm and "cuts out" when engine speed is reduced to approximately 1000 rpm. Full rated output of the generator is developed above 1650 rpm. A cutout switch isolates the battery from the electrical system during inverted flight. Two inverters change direct current to alternating current to power the radio compass and remote-indicating compass.

**CIRCUIT BREAKERS.**

All d-c circuits, including those for communication equipment, are protected from overloads by push-to-reset circuit breakers. On some airplanes,\* the circuit breakers (6, 16, and 21, figure 1-18) are located in the front cockpit on the right console. On other airplanes,† the circuit breakers (14, figure 1-19) are located in the front cockpit just above the right console.

**EXTERNAL POWER RECEPTACLE.**

An external power receptacle is located on the left side of the fuselage below the rear entrance step. Whenever available, external power should be used for engine starting or electrical ground checks to conserve battery power for use during in-flight emergencies.

**ELECTRICAL POWER SUPPLY SYSTEM CONTROLS AND INDICATOR.**

**BATTERY-DISCONNECT SWITCH.** A battery-disconnect switch (2, figure 1-18) is located in the front cockpit on the right console. All electrical equipment is inoperative when the switch is OFF unless the generator is operating or an external power supply is connected to the airplane. The battery will supply current to all electrical equipment when the battery switch is ON and no other power source is being used. The switch should be OFF when the engine is not running to prevent unnecessary discharge of the battery.

**GENERATOR MAIN LINE SWITCH.** A generator main line switch (1, figure 1-18), located in the front cockpit on the right console, provides a means of turning off the generator circuit in case the reverse-current relay fails to operate. A guard covers the generator switch and, when down, holds the switch in the ON position. The switch should be left ON at all times except in an emergency.

**AMMETER.** An ammeter (13, figure 1-15; 19, figure 1-21), mounted on the instrument panel in each cockpit, indicates the amount of current being delivered by the generator.

\*Airplanes AF49-2897 thru -3537, AF50-1277 thru -1326, AF51-15138 thru -15237, and AF51-16071 thru -16077

†Airplanes AF51-14314 thru -15137, and -17354 and subsequent

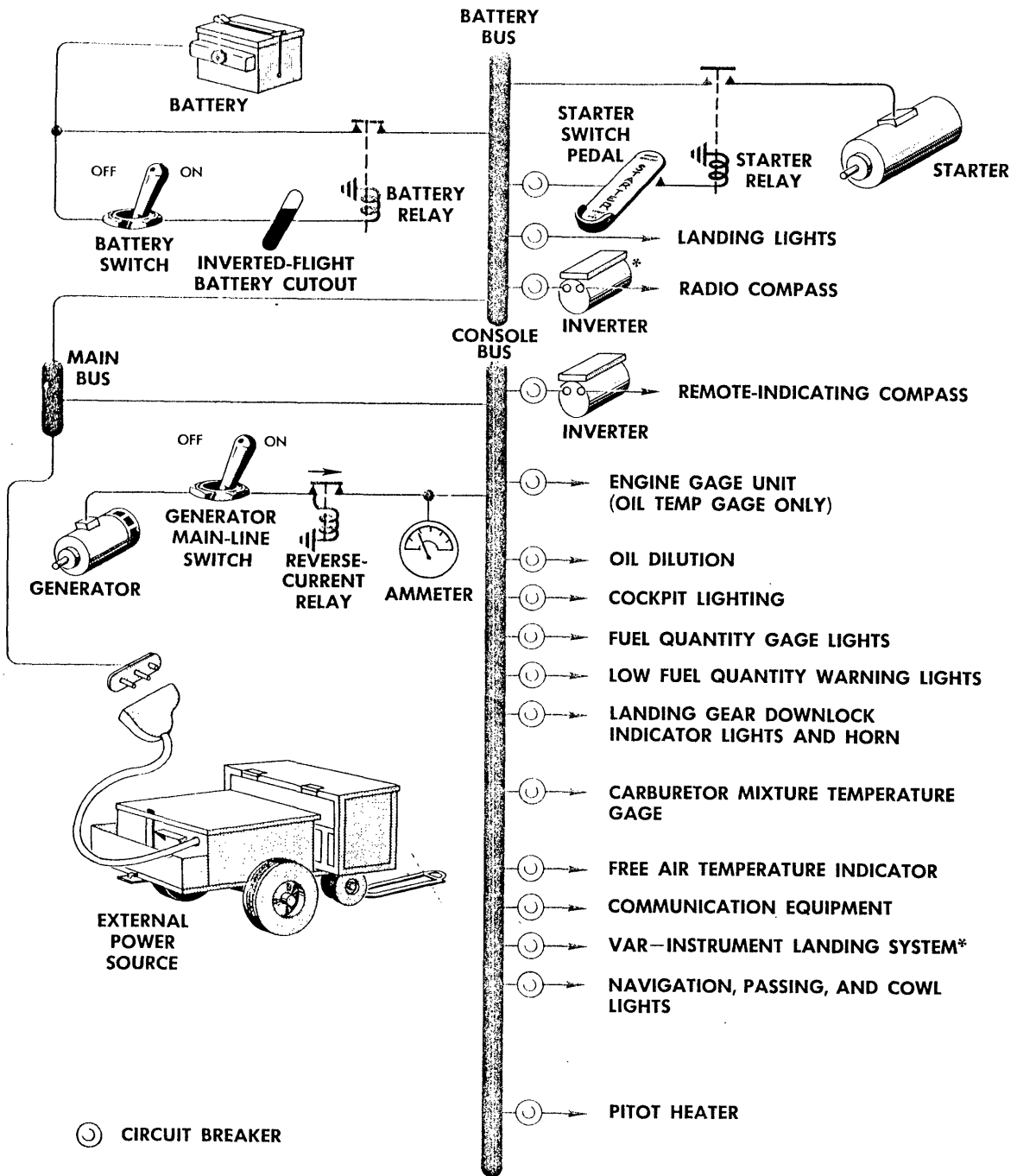

\*AIRPLANES AF49-2897 THROUGH -3537, AF50-1277 THROUGH -1326, AF51-15138 THROUGH -15237, AND AF51-16071 AND SUBSEQUENT

168-54-4572B

# ELECTRICAL SYSTEM

Figure 1-10

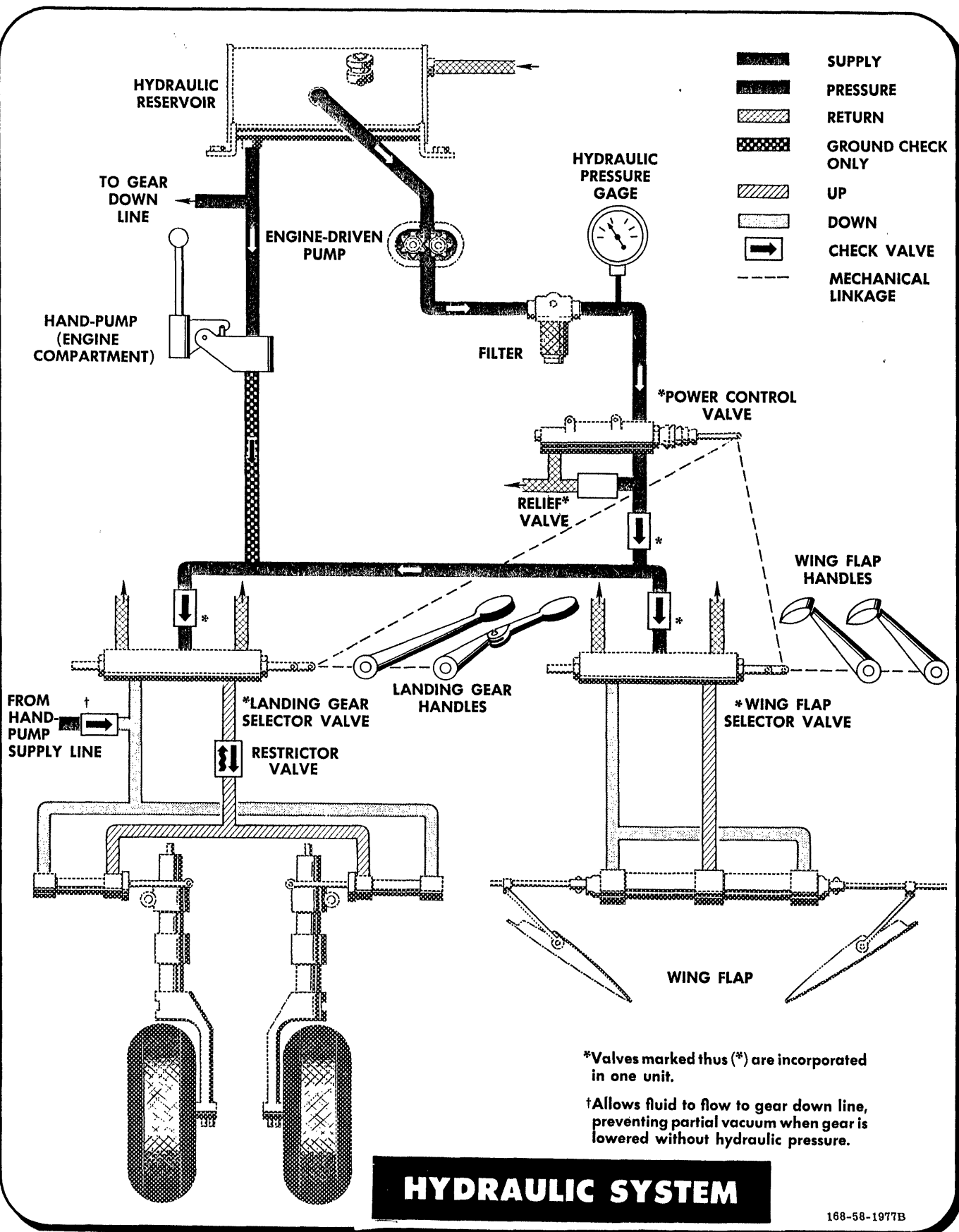

Figure 1-11

### HYDRAULIC POWER SUPPLY SYSTEM.

The hydraulic system (figure 1-11) is utilized to operate the landing gear and flaps. An engine-driven pump supplies hydraulic pressure for operation of these units. However, when no hydraulic units are being operated in flight, the entire output of the pump is diverted to the reservoir. The hydraulic pressure gage (25, figure 1-15), located on the instrument subpanel in the front cockpit, indicates pressure only when a unit is being operated. When either the landing gear or wing flap control is actuated with the engine-driven pump operating, a power control valve automatically engages and diverts fluid to the desired operating unit. Hydraulic fluid is supplied to the master brake cylinder from the hydraulic reservoir. For hydraulic fluid grade and specification, see figure 1-27. The power control valve operates on a time-lag principle and automatically disengages after a set length of time, which is approximately twice that necessary to operate the flaps and landing gear. After the power control valve disengages, fluid is diverted back to the reservoir. No emergency means of obtaining hydraulic pressure in flight is available.

### HYDRAULIC HAND-PUMP.

A hand-pump in the engine compartment is provided for ground check of the hydraulic system.

### FLIGHT CONTROL SYSTEM.

The primary flight control surfaces (ailerons, rudder, and elevator) may be operated from either cockpit by conventional stick and rudder pedal controls. Rudder pedals, which are also used to apply the brakes and for tail wheel steering, are adjustable fore and aft. Trim tabs on the elevator and rudder are mechanically operated from either cockpit. Aileron trim tabs are adjustable on the ground only. The rudder pedals and control stick can be locked by a mechanical lock in the front cockpit.

### FLIGHT CONTROLS.

**CONTROL STICK.** The control sticks in both cockpits incorporate a gun-type handle for positive gripping. The rear cockpit control stick, which can be stowed in a bracket at the left side of the cockpit, is removed by actuating a release knob (17, figure 1-23) at the lower rear side of the stick. In addition to controlling the ailerons and elevators, the control stick also unlocks the tail wheel (to free-swivel) when placed full forward.

**RUDDER PEDAL ADJUSTMENT.** A rudder pedal adjustment lever (2, figure 1-20) is located on the inboard side of each rudder pedal in both cockpits. Adjustment of the pedals is accomplished by moving the individual rudder pedal lever inboard and adjusting the rudder pedal until the desired position is obtained. The lever is then released to lock the pedal in the selected position.

**TRIM TAB CONTROLS.** Rudder and elevator trim tab control wheels (6 and 20, figure 1-17; 3 and 5, figure 1-23) are located on the left console of each cockpit. Trim tab position may be determined from a pointer at each control wheel.

### CONTROL LOCK HANDLE (AILERONS, RUDDER, AND ELEVATOR).

All surface controls are locked by means of a control lock handle (7, figure 1-20), located forward of the control stick in the front cockpit. In order for the controls to be locked, the rudder pedals must be in neutral and the stick forward of center. After the lock handle is raised from the forward (stowed) position, the control stick is moved into the lock recess and the handle is depressed rearward. When not in use, the lock should be stowed (full forward and down).

### WING FLAPS.

Hydraulically operated, split-type wing flaps extend from aileron to aileron. The flaps, operable from either cockpit, travel 45 degrees to the full down position. No emergency means are provided for raising or lowering the flaps.

### WING FLAP HANDLE.

The wing flaps are operated by means of a control handle (2, figure 1-17; 21, figure 1-23), the handle is shaped in the form of an airfoil to facilitate recognition by feel and preclude the necessity of looking for the control. The flap control handle has three positions: UP, DOWN, and LOCK. The LOCK position is used only to lock the flaps in an intermediate position. The flaps are held in the respective up, down, or intermediate positions by trapped fluid in the lines.

### WING FLAP POSITION INDICATOR.

The mechanical wing flap position indicators (23, figure 1-15; 8, figure 1-23) are located on the instrument subpanel in the front cockpit and on the left console in the rear cockpit. Each indicator is marked in increments of 5 to 45 degrees to visually indicate the position of the flaps at all times.

### LANDING GEAR SYSTEM.

The retractable main landing gear is hydraulically operated, and mechanical locks hold the gear in both the down and up positions. The locks are mechanically released by initial movement of the landing gear handle. In case of hydraulic failure, the gear can be unlocked by the landing gear handle and will extend by its own weight. The downlocks will then in snap place. An emergency landing gear downlock handle is provided to mechanically engage the downlock pins in an emergency. A plastic window (figure 1-12) on each wing, above the respective strut, makes possible a visual check of the downlock pin engagement. The tail wheel does not retract.

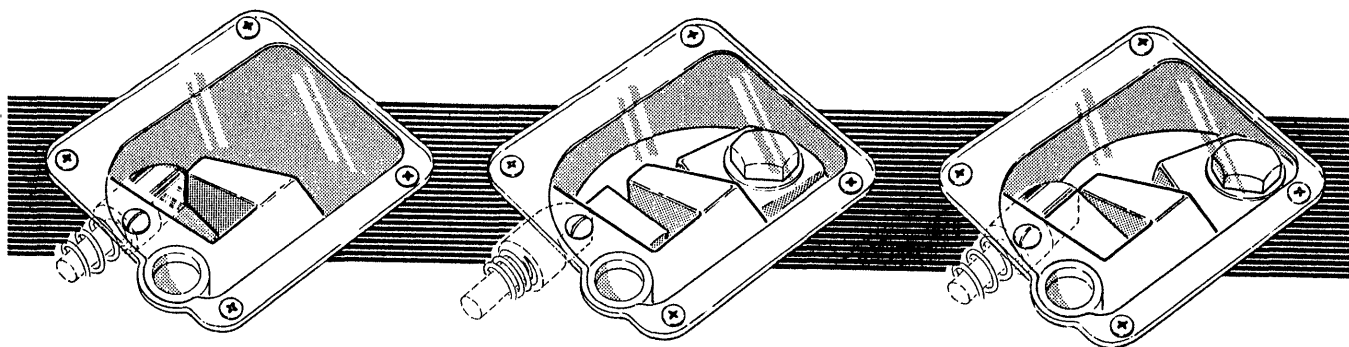

**GEAR EXTENDING (GEAR HANDLE DOWN). DOWNLOCK PIN IN EXTENDED POSITION.**

**GEAR DOWN BUT UNSAFE. DOWNLOCK PIN NOT ENGAGED.**

**GEAR FULLY DOWN WITH DOWNLOCK PIN PROPERLY ENGAGED.**

**Figure 1-12. Landing Gear Downlock Pin Engagement**

168-33-949A

### LANDING GEAR CONTROLS.

**LANDING GEAR HANDLE.** The landing gear handle (19, figure 1-17; 7, figure 1-23) is mounted on the left console of each cockpit. Each gear handle is shaped in the form of a wheel to facilitate recognition by feel and preclude the necessity of looking for the control. Moving the front cockpit handle to either UP or DOWN mechanically positions the gear uplocks or downlocks, actuates the power control valve to pressurize the system, and operates the gear selector valve to raise or lower the gear. There is no neutral position, so the handle must remain in the selected position. The landing gear handle in the rear cockpit also has an UP and a DOWN position, but will only extend the gear. Although the rear handle can be raised, it will not cause the gear to retract, because the front handle is engaged in a detent when at DOWN. (See figure 1-13.)



Do not operate the front cockpit landing gear handle when the airplane is on the ground, as there is no safety provision to prevent retraction of the gear.

**EMERGENCY LANDING GEAR DOWNLOCK HANDLE.** The emergency landing gear downlock handle (18, figure 1-17) is located on the left side of the pilot's seat in the front cockpit. The handle is pulled back to manually force the downlock pins into place if the pins fail to automatically lock the gear down. However, the handle must never be actuated until the gear is completely down; otherwise, the downlock pins, while manually forced into place, may not allow the gear to extend fully. After the handle is pulled back, a spring returns it to the normal forward position; however, the downlock pins remain engaged. (See figure 1-13.)

### LANDING GEAR INDICATORS.

**LANDING GEAR POSITION INDICATOR.** A mechanical landing gear position indicator (22, figure 1-15) is located on the instrument subpanel in the front cockpit. The indicator shows the approximate position of each gear at all times.

**LANDING GEAR DOWNLOCK INDICATOR LIGHTS.** The front cockpit landing gear downlock indicator lights (21, figure 1-15), are located on the instrument subpanel. The rear cockpit landing gear indicator lights (16, figure 1-23) are located on a panel just below and to the left of the instrument panel. The lights (one for each gear) will illuminate when the gear is down and locked. In addition, downlock indicator lights (figure 4-5) are installed on the leading edge of each wing near the wheel well. Although these external indicator lights (one for each gear) are not visible to the pilot, they enable ground-observer verification of gear position as a safety feature for night flight training. The external downlock indicator lights illuminate when the gear is down and locked and the navigation lights are on.

**LANDING GEAR WARNING HORN.** A warning horn is located behind and to the left of the front cockpit seat. If the landing gear is not locked in the DOWN position, the horn will blow when the throttle is retarded.

### STEERING SYSTEM.

The nonretractable tail wheel can be steered or allowed to free-swivel, as determined by the position of the control stick. With the control stick in any position except full forward, the tail wheel can be steered by the rudder pedals up to a maximum of 15 degrees either side of center. Moving the control stick to the full forward position allows the tail wheel to free-swivel, and the airplane must be steered by the brakes. If the tail wheel is not aligned with the rudder when the control stick is moved back from the full forward position, the wheel will not be controllable. However, subsequent alignment with the rudder will automatically engage the tail wheel for steering.

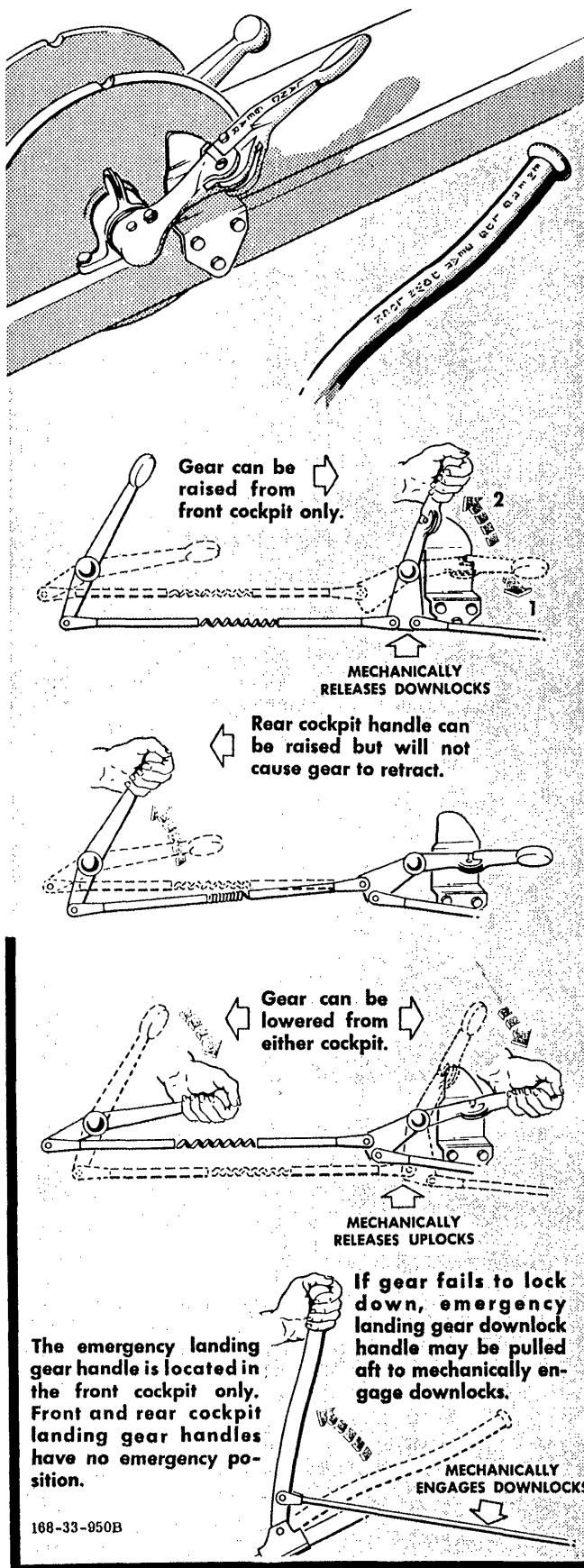

Figure 1-13. Landing Gear Handles and Emergency Downlock Handle

Revised 30 June 1953

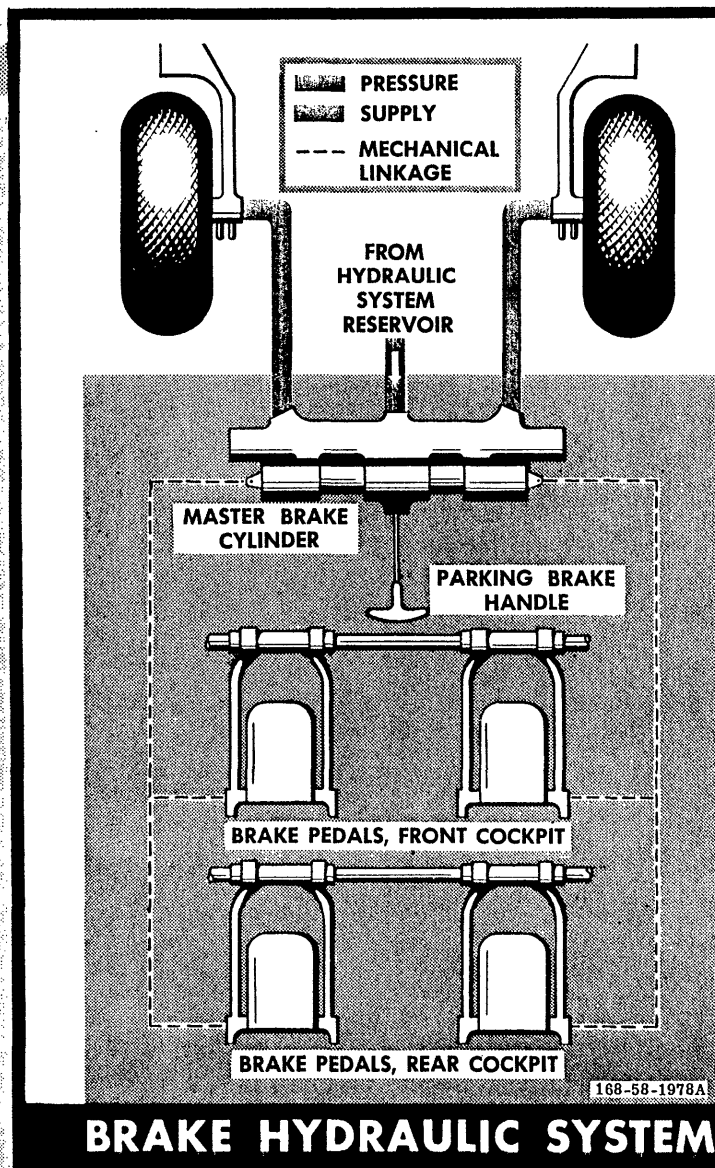

Figure 1-14

**BRAKE SYSTEM.**

Hydraulic brakes on the main wheels are operated by application of toe pressure on the rudder pedals. No emergency method of applying the brakes is provided. The brake system (figure 1-14) incorporates a master brake cylinder, which is supplied with fluid from the hydraulic system reservoir. A parking brake handle (1, figure 1-20) is installed in the front cockpit. Parking brakes are set by depressing the toe brakes, pulling the parking brake handle out, and then releasing the toe brakes. The parking brakes are released by depressing the toe brakes in either cockpit.

**INSTRUMENTS.**

A complete set of engine and flight instruments is installed in each cockpit, with the exception of the hydraulic pressure gage, which is installed only in the

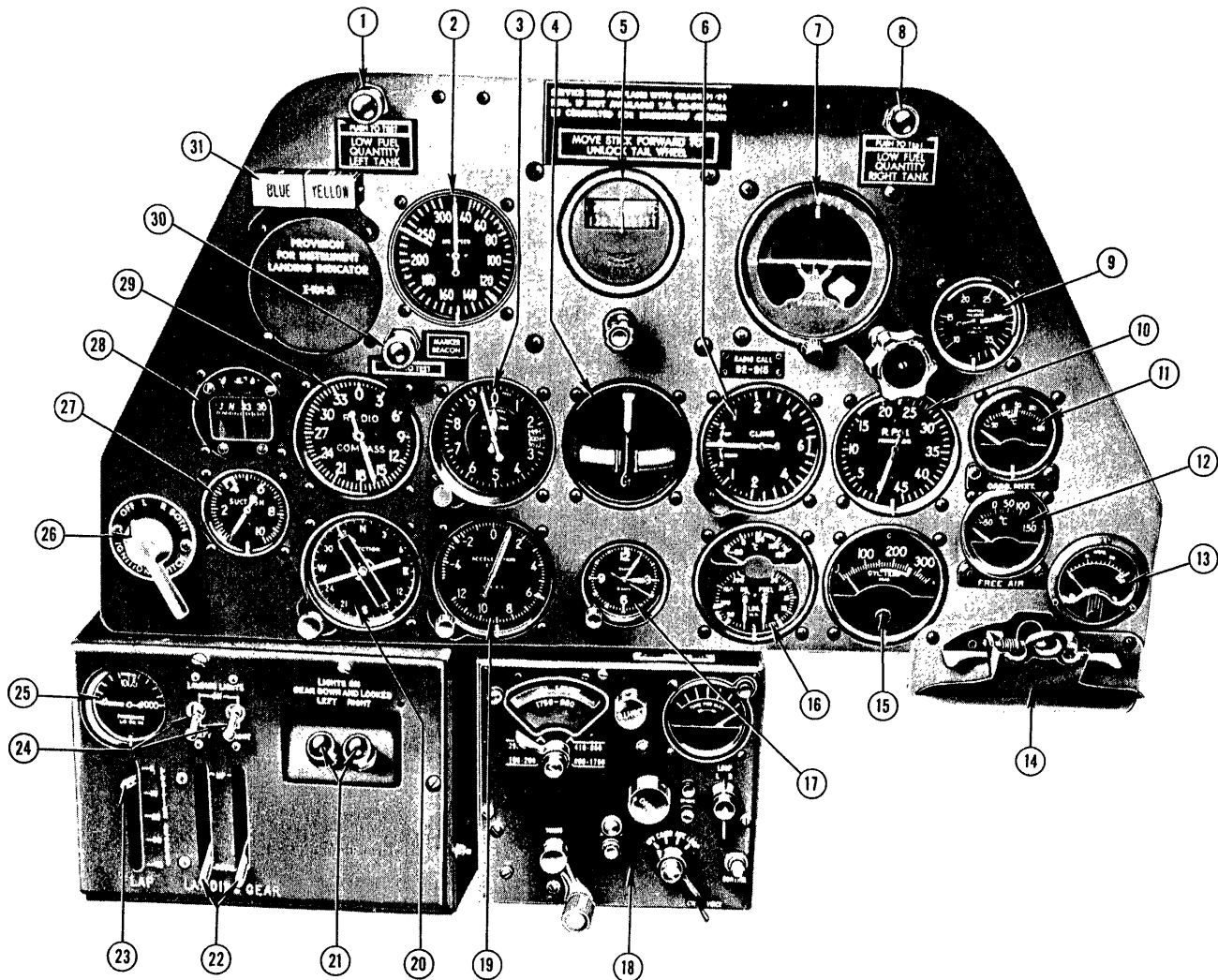

1. LEFT TANK LOW FUEL QUANTITY WARNING LIGHT
2. AIRSPEED INDICATOR
3. ALTIMETER
4. TURN-AND-BANK INDICATOR
5. DIRECTIONAL GYRO
6. RATE-OF-CLIMB INDICATOR
7. GYRO HORIZON
8. RIGHT TANK LOW FUEL QUANTITY WARNING LIGHT
9. MANIFOLD PRESSURE GAGE
10. TACHOMETER
11. CARBURETOR MIXTURE TEMPERATURE GAGE
12. FREE AIR TEMPERATURE GAGE
13. AMMETER
14. CHART CLIP
15. CYLINDER HEAD TEMPERATURE GAGE
16. ENGINE GAGE UNIT
17. CLOCK
18. RADIO COMPASS CONTROL PANEL
19. ACCELEROMETER
20. REMOTE-INDICATING COMPASS INDICATOR
21. LANDING GEAR DOWNLOCK INDICATOR LIGHTS
22. LANDING GEAR POSITION INDICATORS
23. WING FLAP POSITION INDICATOR
24. LANDING LIGHT SWITCHES
25. HYDRAULIC PRESSURE GAGE
26. IGNITION SWITCH
27. SUCTION GAGE
28. MAGNETIC COMPASS
29. RADIO COMPASS INDICATOR
30. MARKER BEACON SIGNAL LIGHT
31. COURSE REMINDER

## Front cockpit

### FORWARD VIEW

Airplanes AF49-2897 through -3537,  
AF50-1277 through -1326, AF51-15138  
through -15237, and -16071 through  
-16077

Figure 1-15



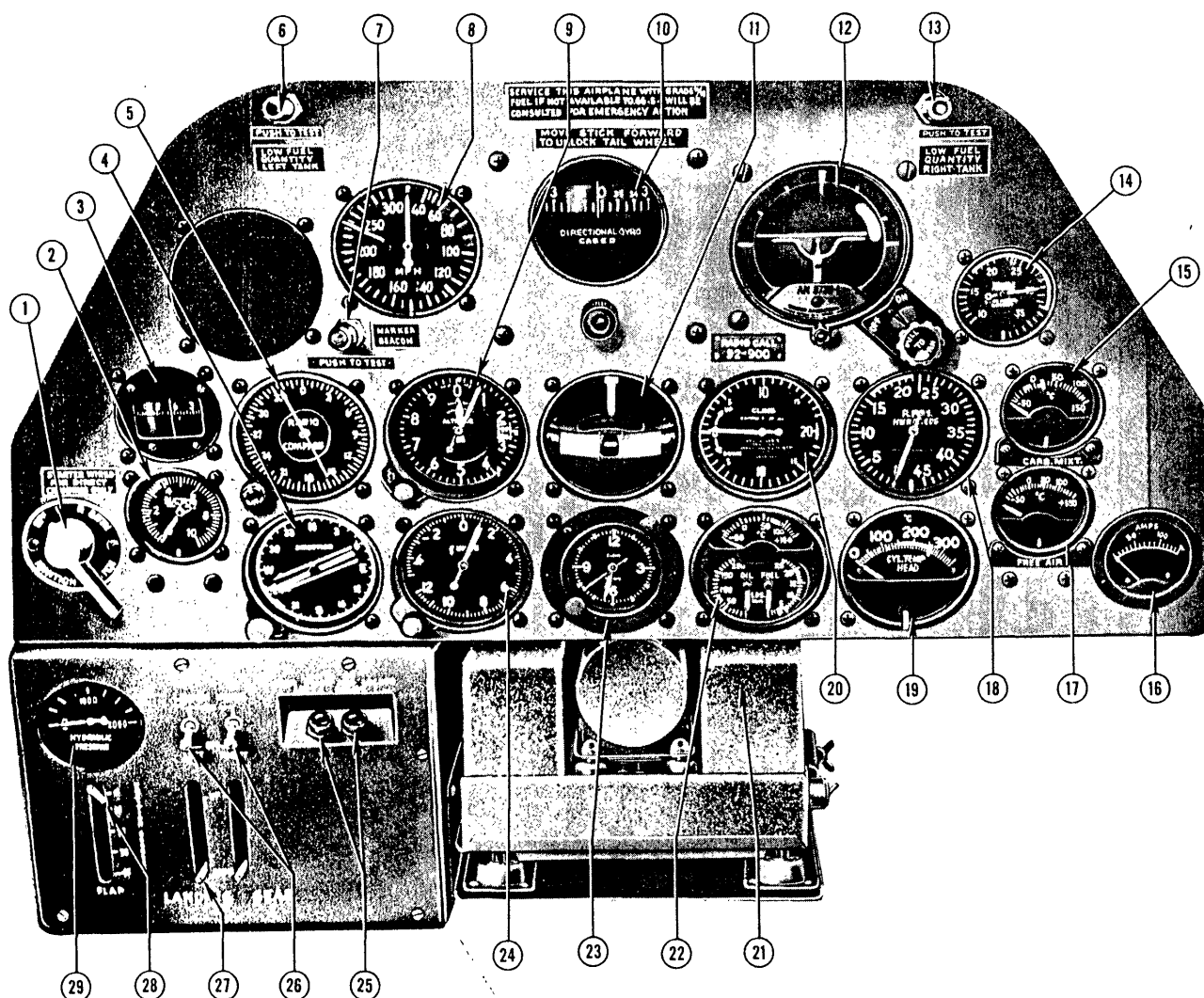

- |  |  |
|--|--|
| 1. IGNITION SWITCH                             | 15. CARBURETOR MIXTURE TEMPERATURE GAGE    |
| 2. SUCTION GAGE                                | 16. AMMETER                                |
| 3. MAGNETIC COMPASS                            | 17. FREE AIR TEMPERATURE GAGE              |
| 4. REMOTE-INDICATING COMPASS INDICATOR         | 18. TACHOMETER                             |
| 5. RADIO COMPASS INDICATOR                     | 19. CYLINDER HEAD TEMPERATURE GAGE         |
| 6. LEFT TANK LOW FUEL QUANTITY WARNING LIGHT   | 20. RATE-OF-CLIMB INDICATOR                |
| 7. MARKER BEACON SIGNAL LIGHT                  | 21. INTERPHONE AMPLIFIER                   |
| 8. AIRSPEED INDICATOR                          | 22. ENGINE GAGE UNIT                       |
| 9. ALTIMETER                                   | 23. CLOCK                                  |
| 10. DIRECTIONAL GYRO                           | 24. ACCELEROMETER                          |
| 11. TURN-AND-BANK INDICATOR                    | 25. LANDING GEAR DOWNLOCK INDICATOR LIGHTS |
| 12. GYRO HORIZON                               | 26. LANDING LIGHT SWITCHES                 |
| 13. RIGHT TANK LOW FUEL QUANTITY WARNING LIGHT | 27. LANDING GEAR POSITION INDICATORS       |
| 14. MANIFOLD PRESSURE GAGE                     | 28. WING FLAP POSITION INDICATOR           |
|  | 29. HYDRAULIC PRESSURE GAGE                |

# Front cockpit

FORWARD VIEW

Airplanes AF51-14314 through -15137,  
and -17354 and subsequent

168-00-1077B

Figure 1-16

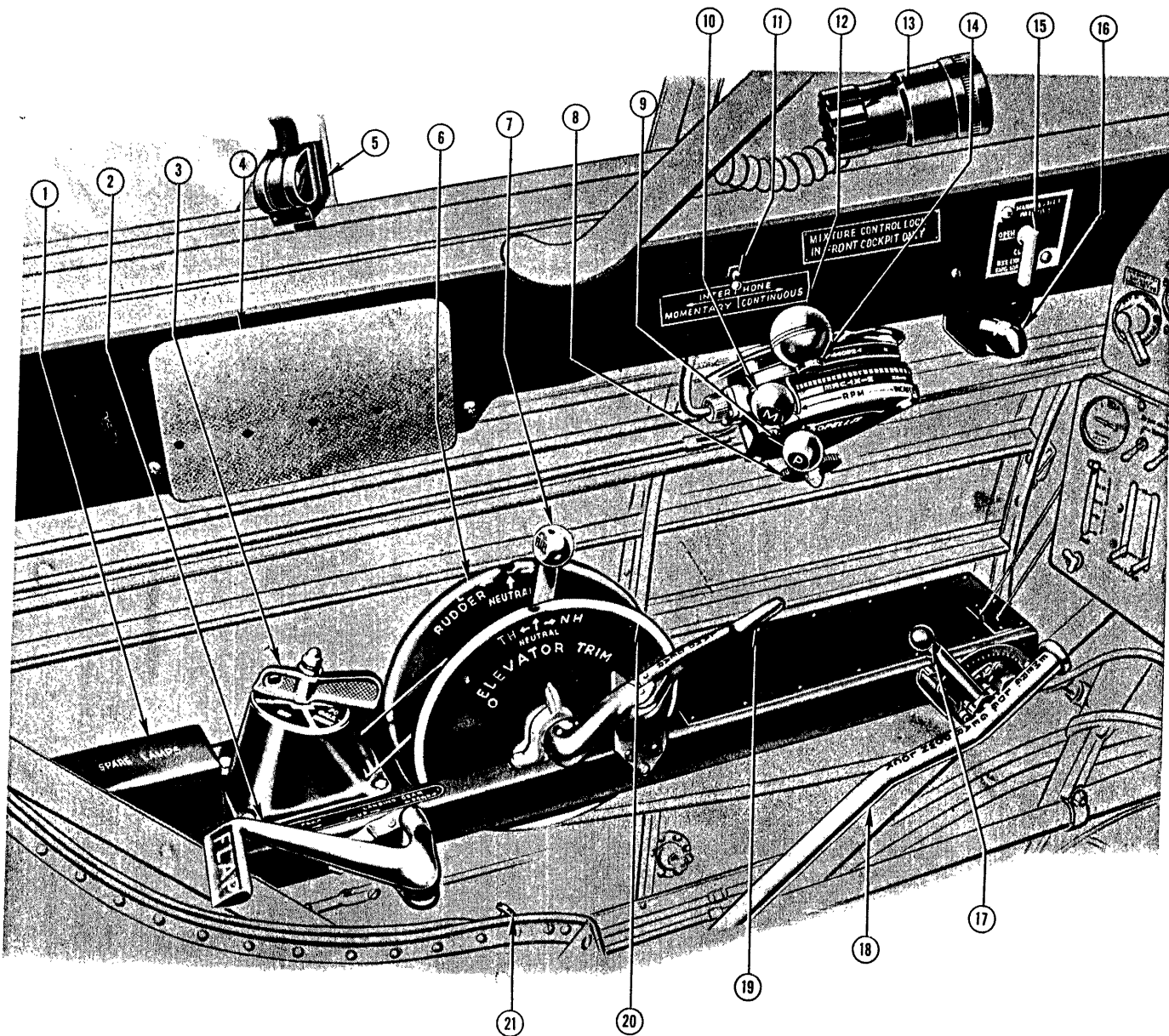

# Front cockpit

LEFT SIDE

- |                                    |   |
|------------------------------------|---|
| 1. SPARE LAMPS BOX                 | 12. THROTTLE                                  |
| 2. WING FLAP HANDLE                | 13. FLUORESCENT LIGHT CONTROL KNOB            |
| 3. FUEL SELECTOR                   | 14. MICROPHONE CONTROL BUTTON                 |
| 4. ARMREST                         | 15. MANIFOLD PRESSURE GAGE DRAIN VALVE HANDLE |
| 5. CANOPY HANDLE                   | 16. COCKPIT LIGHT                             |
| 6. RUDDER TRIM TAB CONTROL WHEEL   | 17. CARBURETOR AIR CONTROL                    |
| 7. HAND FUEL PUMP HANDLE           | 18. EMERGENCY LANDING GEAR DOWNLOCK HANDLE    |
| 8. THROTTLE QUADRANT FRICTION LOCK | 19. LANDING GEAR HANDLE                       |
| 9. PROPELLER CONTROL               | 20. ELEVATOR TRIM TAB CONTROL WHEEL           |
| 10. MIXTURE CONTROL                | 21. SHOULDER HARNESS LOCK HANDLE              |
| 11. INTERPHONE SWITCH              |   |

188-00-1078A

Figure 1-17

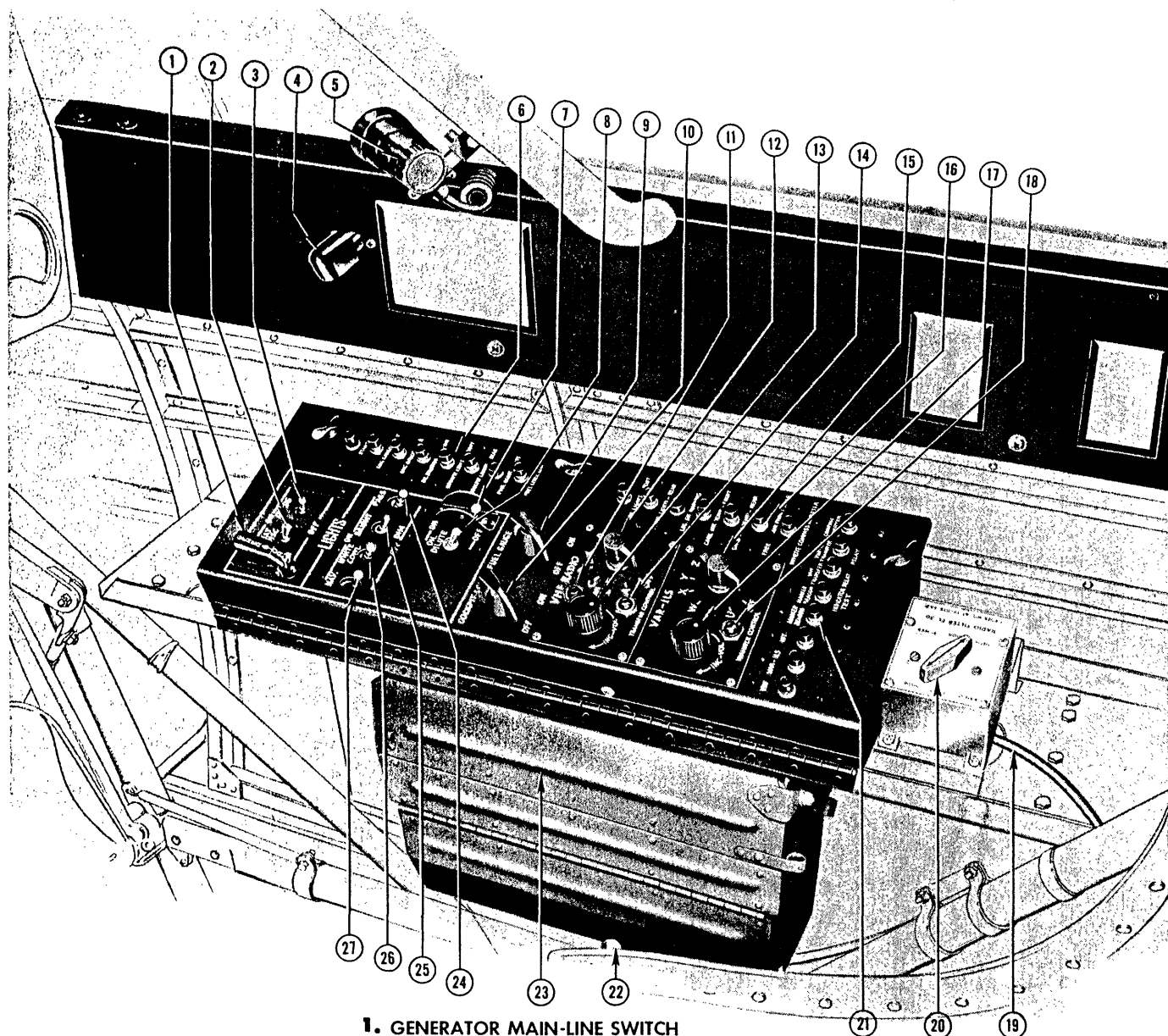

# Front cockpit

## RIGHT SIDE

Airplanes AF49-2897 through -3537,  
AF50-1277 through -1326, AF51-15138  
through -15237, and -16071 through  
-16077

- |                                       |  |
|---------------------------------------|--|
| 1. GENERATOR MAIN-LINE SWITCH         | 15. ILS CHANNEL SELECTOR SWITCH                    |
| 2. BATTERY-DISCONNECT SWITCH          | 16. CIRCUIT BREAKERS                               |
| 3. GYRO SWITCH                        | 17. ILS VOLUME CONTROL KNOB                        |
| 4. COCKPIT LIGHT                      | 18. ILS CONTROL TRANSFER PUSH BUTTON*              |
| 5. FLUORESCENT LIGHT CONTROL KNOB     | 19. RADIO EARPHONE CORD                            |
| 6. CIRCUIT BREAKERS                   | 20. RADIO RANGE FILTER SWITCH*                     |
| 7. PITOT HEATER SWITCH                | 21. CIRCUIT BREAKERS                               |
| 8. OIL DILUTION SWITCH                | 22. SEAT ADJUSTMENT LEVER                          |
| 9. FUEL GAGE LIGHT RHEOSTAT           | 23. MAP AND DATA CASE                              |
| 10. COCKPIT LIGHT RHEOSTAT            | 24. PASSING LIGHT SWITCH                           |
| 11. D/F TONE PUSH BUTTON*             | 25. NAVIGATION AND COWL LIGHT<br>BRILLIANCY SWITCH |
| 12. VHF CHANNEL SELECTOR SWITCH       | 26. COWL LIGHT SWITCH                              |
| 13. VHF RADIO VOLUME CONTROL KNOB     | 27. NAVIGATION LIGHT SWITCH                        |
| 14. VHF CONTROL TRANSFER PUSH BUTTON* |  |

\*Airplanes AF49-2982 through -3537, AF50-1277 through -1326,  
AF51-15138 through -15237, and -16071 through -16077

Figure 1-18

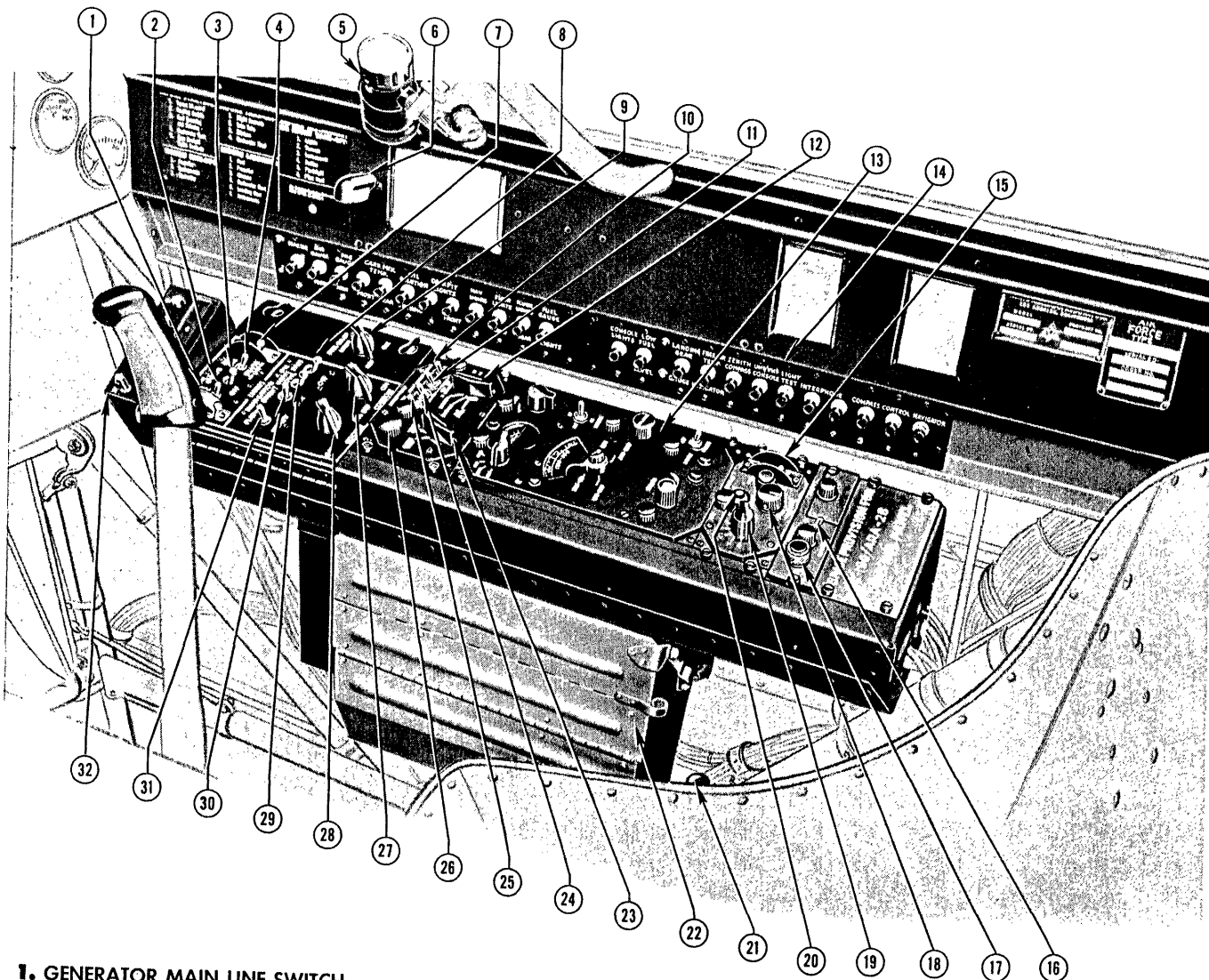

- |   |   |
|---|---|
| <b>1.</b> GENERATOR MAIN LINE SWITCH                      | <b>18.</b> VHF AUDIO CONTROL KNOB †                       |
| <b>2.</b> BATTERY-DISCONNECT SWITCH                       | <b>19.</b> VHF CHANNEL SELECTOR SWITCH †                  |
| <b>3.</b> GYRO SWITCH                                     | <b>20.</b> D/F TONE PUSH BUTTON †                         |
| <b>4.</b> OIL DILUTION SWITCH                             | <b>21.</b> SEAT ADJUSTMENT LEVER                          |
| <b>5.</b> FLUORESCENT LIGHT CONTROL KNOB                  | <b>22.</b> MAP AND DATA CASE                              |
| <b>6.</b> COCKPIT LIGHT                                   | <b>23.</b> RADIO RANGE FILTER SWITCH                      |
| <b>7.</b> PITOT HEATER SWITCH                             | <b>24.</b> RADIO COMPASS SWITCH                           |
| <b>8.</b> PASSING LIGHT SWITCH                            | <b>25.</b> INTERPHONE SWITCH<br>(DISCONNECTED*)           |
| <b>9.</b> FUEL GAGE LIGHT RHEOSTAT                        | <b>26.</b> MASTER VOLUME CONTROL KNOB                     |
| <b>10.</b> LOCALIZER SWITCH (DISCONNECTED)                | <b>27.</b> CONSOLE LIGHT RHEOSTAT                         |
| <b>11.</b> MARKER BEACON SWITCH (DISCONNECTED*)           | <b>28.</b> COCKPIT LIGHT RHEOSTAT                         |
| <b>12.</b> MASTER SELECTOR SWITCH                         | <b>29.</b> COWL LIGHT SWITCH                              |
| <b>13.</b> RADIO COMPASS CONTROL PANEL                    | <b>30.</b> NAVIGATION AND COWL LIGHT<br>BRILLIANCY SWITCH |
| <b>14.</b> CIRCUIT BREAKERS                               | <b>31.</b> NAVIGATION LIGHT SWITCH                        |
| <b>15.</b> VHF POWER SWITCH †                             | <b>32.</b> VHF RADIO CONTROL PANEL*                       |
| <b>16.</b> VHF CONTROL TRANSFER SWITCH<br>(DISCONNECTED*) |   |
| <b>17.</b> VHF CONTROL INDICATOR LIGHT<br>(DISCONNECTED*) |   |

\*Airplanes AF51-14359 through -14683

†Airplanes AF51-14314 through -14358, -14684 through -15137, and -17354 and subsequent

## Front cockpit

RIGHT SIDE

Airplanes AF51-14314 through -15137,  
and -17354 and subsequent

168-00-1081C

Figure 1-19

Revised 30 June 1953

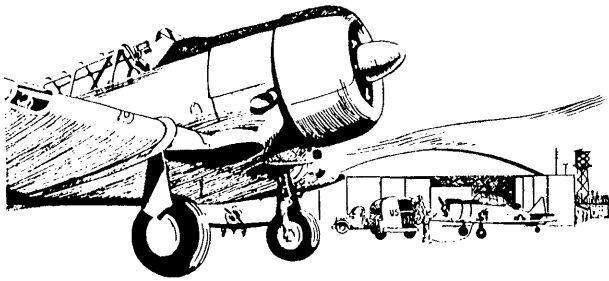

## Front cockpit controls

front cockpit. A suction gage is provided in each cockpit. The gyro horizon, directional gyro, and turn-and-bank indicator are operated by the engine-driven vacuum system. The airspeed indicator is operated by the pitot and static systems, and the altimeter, and rate-of-climb indicator are operated by the static system. The airspeed indicator measures the difference between impact air pressure entering the pitot tube, mounted on the right wing, and static air pressure obtained at vent ports on each side of the rear fuselage. The altimeter and rate-of-climb indicator are connected to the static ports only. To keep the pitot tube opening clean, a cover is placed over the pitot head whenever the airplane is parked. An accelerometer (19, figure 1-15; 25, figure 1-21) is installed on the instrument panel in each cockpit. A free air temperature gage (12, figure 1-15; 18, figure 1-21) is installed on the instrument panel in each cockpit.

**GYRO SWITCH.** The gyro horizon and directional gyro in both cockpits can be caged by the respective caging knob. The gyros in these instruments are also stopped when the gyro switch (3, figure 1-18), located on the right console in the front cockpit, is placed at the OFF position. The gyro switch does not affect the operation of the turn-and-bank indicator.

### EMERGENCY EQUIPMENT.

#### HAND-OPERATED FIRE EXTINGUISHER.

A carbon tetrachloride fire extinguisher (2, figure 1-23) is installed on the left side of the rear cockpit. The extinguisher can also be reached from outside the cockpit through an access door above the wing trailing edge.

#### FIRST-AID KIT.

A first-aid kit (7, figure 1-24), installed on the right aft side of the rear cockpit, is provided for emergency use.

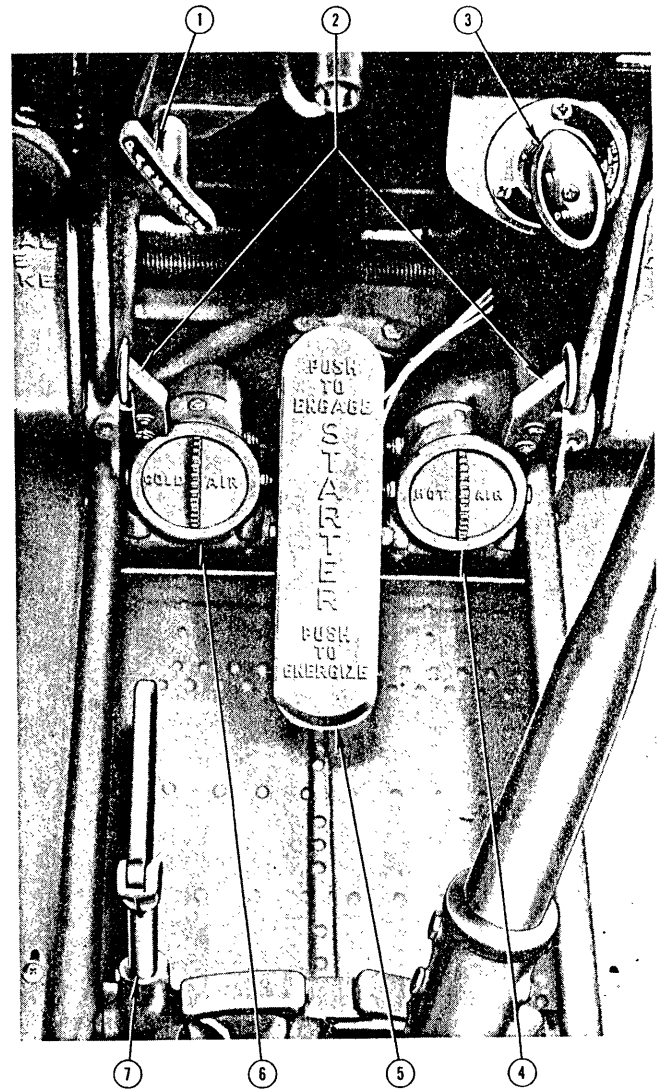

1. PARKING BRAKE HANDLE
2. RUDDER PEDAL ADJUSTMENT LEVERS
3. ENGINE PRIMER
4. HOT-AIR TEMPERATURE CONTROL VALVE
5. STARTER SWITCH PEDAL
6. COLD-AIR TEMPERATURE CONTROL VALVE
7. CONTROL LOCK HANDLE

Figure 1-20

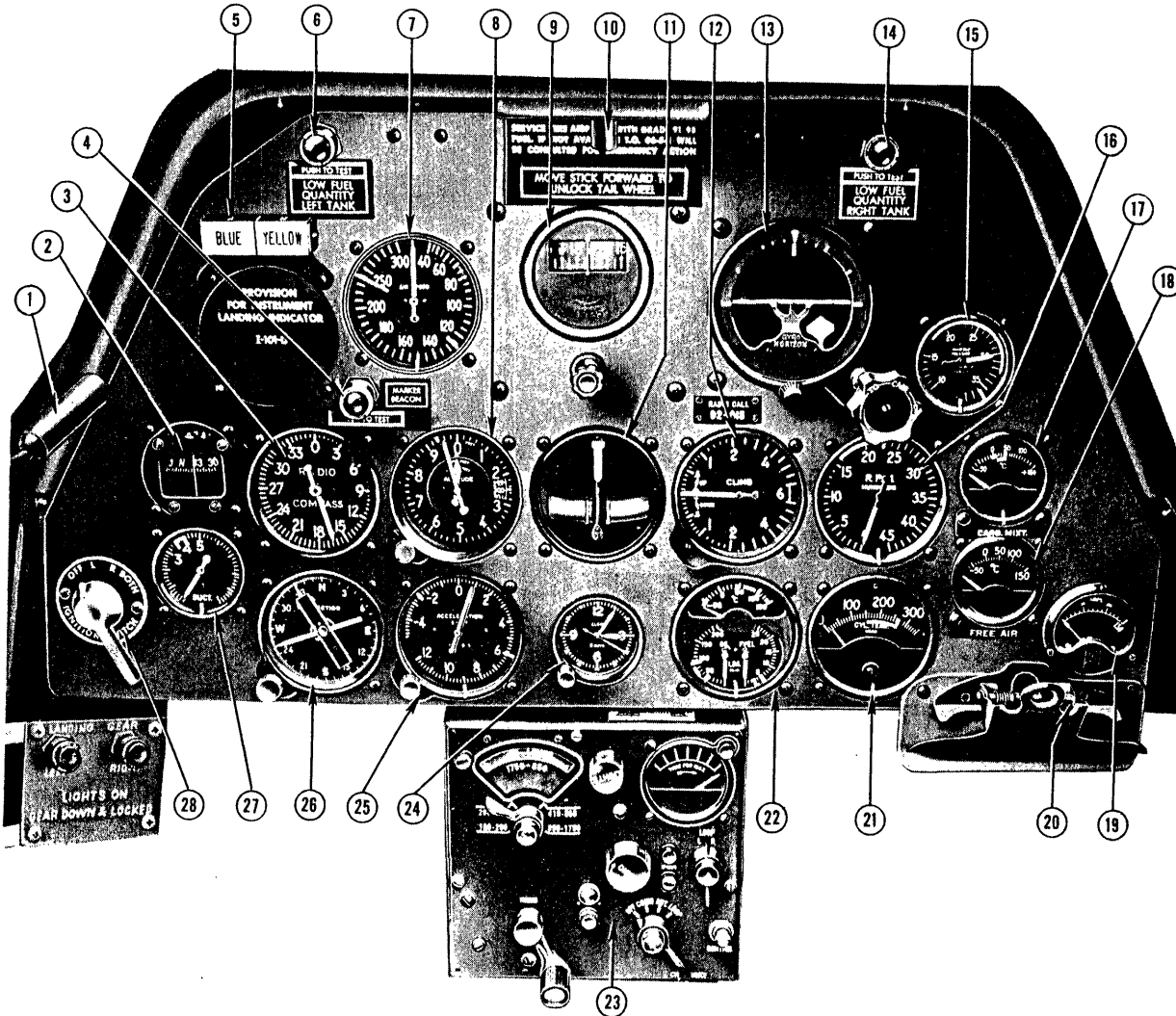

## Rear cockpit

### FORWARD VIEW

Airplanes AF49-2897 through -3537,  
AF50-1277 through -1326, AF51-15138  
through -15237, and -16071 through  
-16077

1. CANOPY HANDLE
2. MAGNETIC COMPASS
3. RADIO COMPASS INDICATOR
4. MARKER BEACON SIGNAL LIGHT
5. COURSE REMINDER
6. LEFT TANK LOW FUEL QUANTITY WARNING LIGHT
7. AIRSPEED INDICATOR
8. ALTIMETER
9. DIRECTIONAL GYRO
10. INSTRUMENT FLYING HOOD RELEASE BUTTON
11. TURN-AND-BANK INDICATOR
12. RATE-OF-CLIMB INDICATOR
13. GYRO HORIZON
14. RIGHT TANK LOW FUEL QUANTITY WARNING LIGHT
15. MANIFOLD PRESSURE GAGE
16. TACHOMETER
17. CARBURETOR MIXTURE TEMPERATURE GAGE
18. FREE AIR TEMPERATURE GAGE
19. AMMETER
20. CHART CLIP
21. CYLINDER HEAD TEMPERATURE GAGE
22. ENGINE GAGE UNIT
23. RADIO COMPASS CONTROL PANEL
24. CLOCK
25. ACCELEROMETER
26. REMOTE-INDICATING COMPASS INDICATOR
27. SUCTION GAGE
28. IGNITION SWITCH

168-00-1082A

Figure 1-21



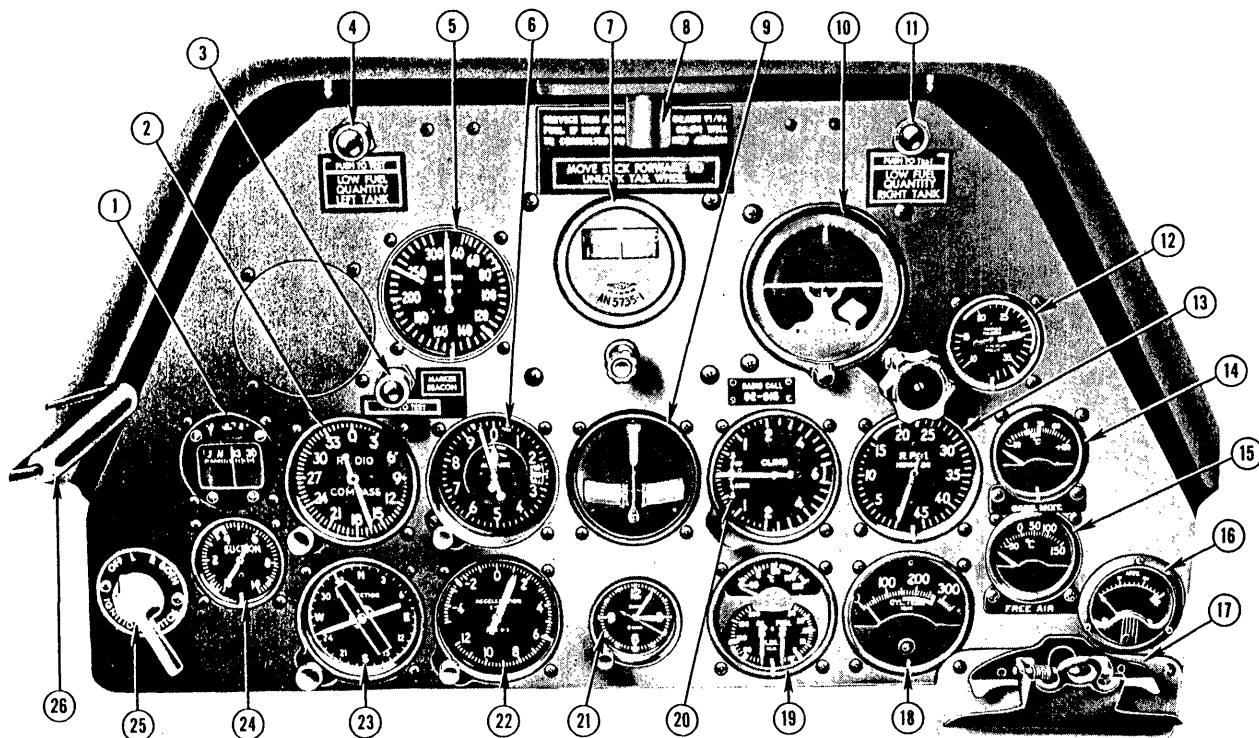

- |  |   |
|--|---|
| 1. MAGNETIC COMPASS                            | 14. CARBURETOR MIXTURE TEMPERATURE GAGE |
| 2. RADIO COMPASS INDICATOR                     | 15. FREE AIR TEMPERATURE GAGE           |
| 3. MARKER BEACON SIGNAL LIGHT                  | 16. AMMETER                             |
| 4. LEFT TANK LOW FUEL QUANTITY WARNING LIGHT   | 17. CHART CLIP                          |
| 5. AIRSPEED INDICATOR                          | 18. CYLINDER HEAD TEMPERATURE GAGE      |
| 6. ALTIMETER                                   | 19. ENGINE GAGE UNIT                    |
| 7. DIRECTIONAL GYRO                            | 20. RATE-OF-CLIMB INDICATOR             |
| 8. INSTRUMENT FLYING HOOD RELEASE BUTTON       | 21. CLOCK                               |
| 9. TURN-AND-BANK INDICATOR                     | 22. ACCELEROMETER                       |
| 10. GYRO HORIZON                               | 23. REMOTE-INDICATING COMPASS INDICATOR |
| 11. RIGHT TANK LOW FUEL QUANTITY WARNING LIGHT | 24. SUCTION GAGE                        |
| 12. MANIFOLD PRESSURE GAGE                     | 25. IGNITION SWITCH                     |
| 13. TACHOMETER                                 | 26. CANOPY HANDLE                       |

**Rear cockpit**

FORWARD VIEW  
Airplanes AF51-14314 through -15137,  
and -17354 and subsequent

Figure 1-22

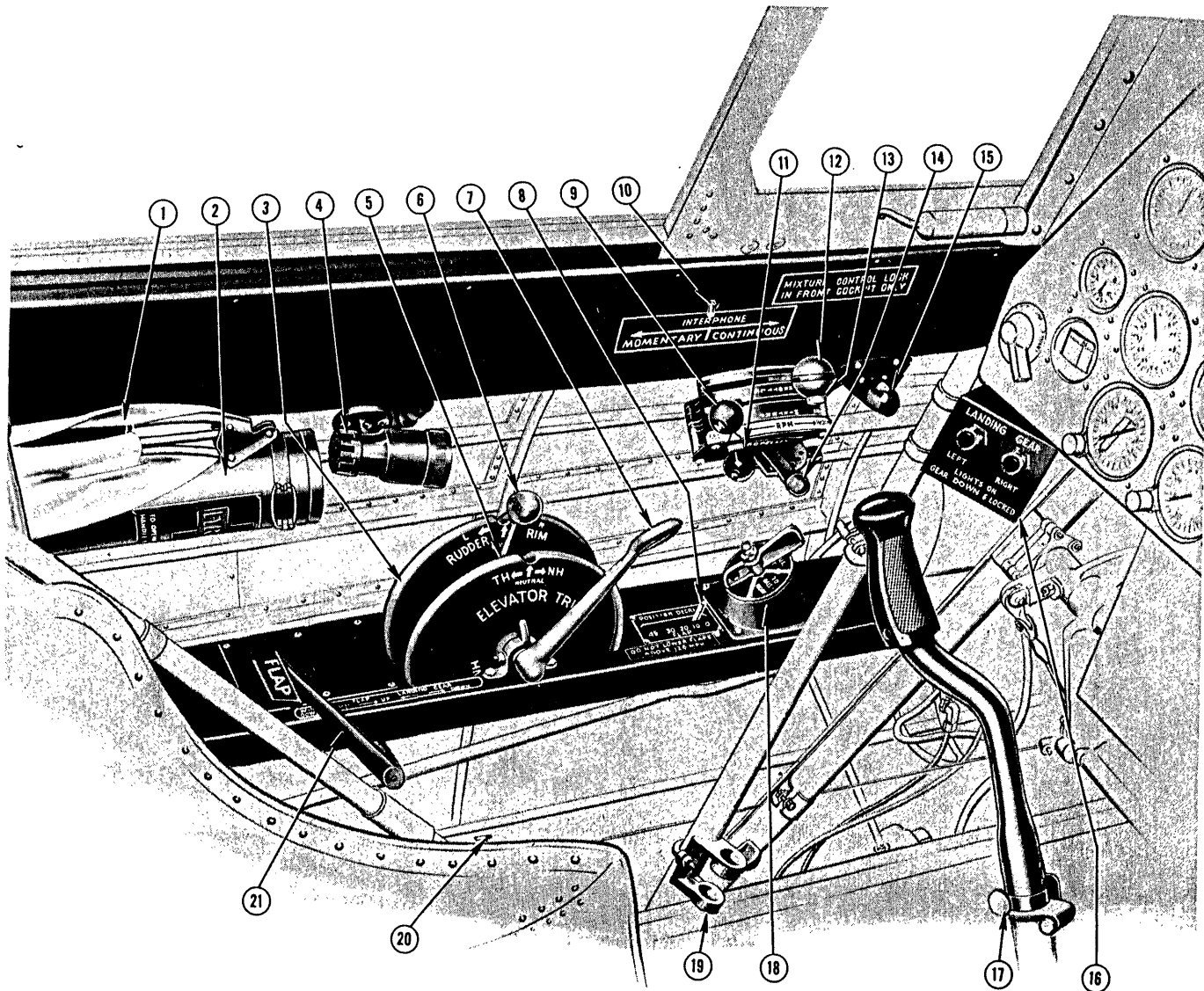

- |   |   |
|---|---|
| <b>1. INSTRUMENT FLYING HOOD</b>          | <b>12. THROTTLE</b>                               |
| <b>2. FIRE EXTINGUISHER</b>               | <b>13. MICROPHONE CONTROL BUTTON</b>              |
| <b>3. RUDDER TRIM TAB CONTROL WHEEL</b>   | <b>14. VENTILATING-AIR HANDLE</b>                 |
| <b>4. FLUORESCENT LIGHT CONTROL KNOB</b>  | <b>15. COCKPIT LIGHT</b>                          |
| <b>5. ELEVATOR TRIM TAB CONTROL WHEEL</b> | <b>16. LANDING GEAR DOWNLOCK INDICATOR LIGHTS</b> |
| <b>6. HAND FUEL PUMP HANDLE</b>           | <b>17. CONTROL STICK RELEASE KNOB</b>             |
| <b>7. LANDING GEAR HANDLE</b>             | <b>18. FUEL SELECTOR</b>                          |
| <b>8. WING FLAP POSITION INDICATOR</b>    | <b>19. CONTROL STICK STOWAGE BRACKET</b>          |
| <b>9. MIXTURE CONTROL</b>                 | <b>20. SHOULDER HARNESS LOCK HANDLE</b>           |
| <b>10. INTERPHONE SWITCH</b>              | <b>21. WING FLAP HANDLE</b>                       |
| <b>11. PROPELLER CONTROL</b>              |   |

## Rear cockpit

LEFT SIDE

168-00-1084A

Figure 1-23



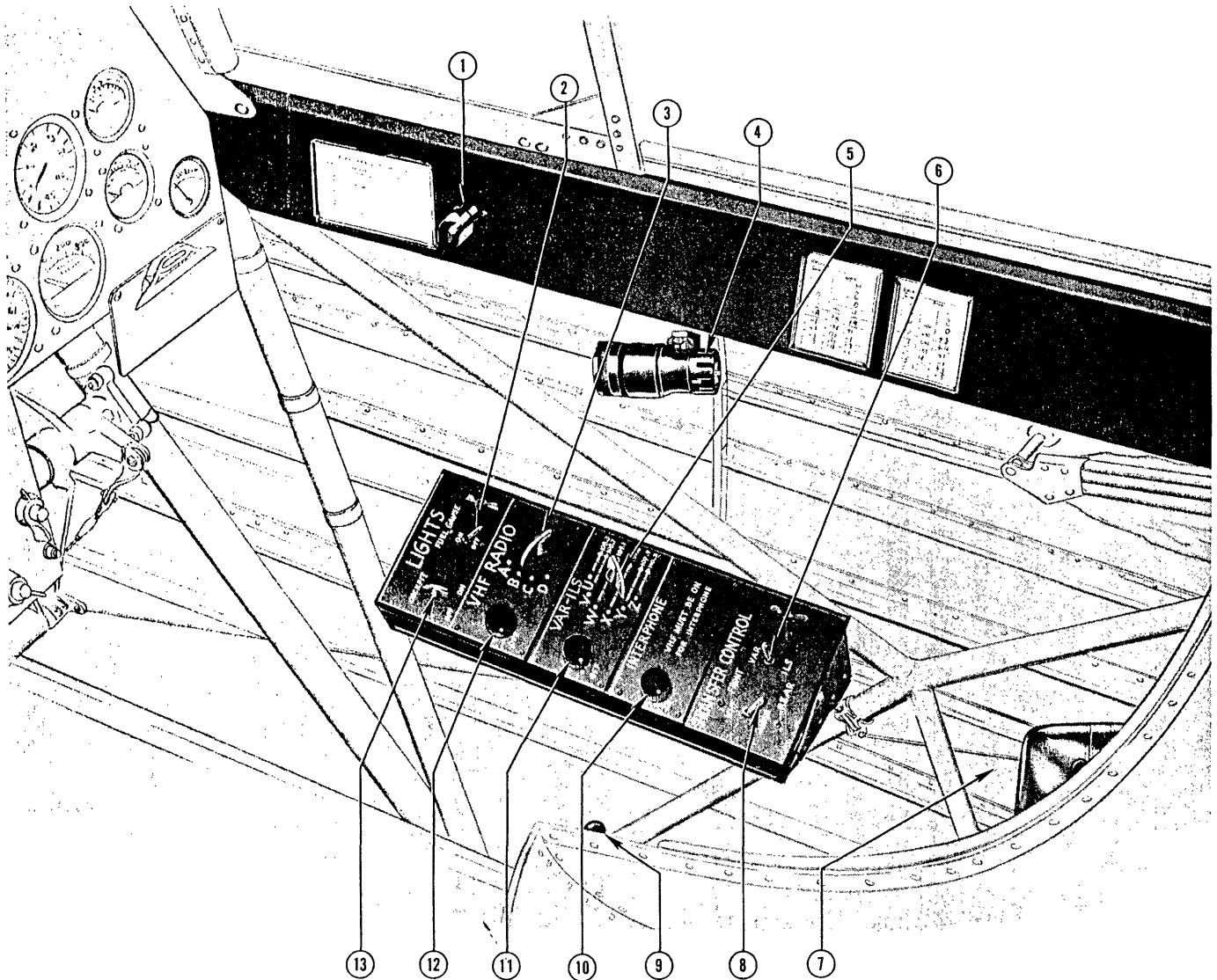

**1. COCKPIT LIGHT**

**2. FUEL GAGE LIGHT SWITCH**

**3. VHF RADIO CHANNEL SELECTOR SWITCH**

**4. FLUORESCENT LIGHT CONTROL KNOB**

**5. ILS CHANNEL SELECTOR SWITCH**

**6. ILS CONTROL TRANSFER SWITCH**

**7. FIRST-AID KIT**

**8. VHF CONTROL TRANSFER SWITCH**

**9. SEAT ADJUSTMENT LEVER**

**10. INTERPHONE VOLUME CONTROL KNOB**

**11. ILS VOLUME CONTROL KNOB**

**12. VHF RADIO VOLUME CONTROL KNOB**

**13. COCKPIT LIGHT RHEOSTAT**

**Rear cockpit**  
**RIGHT SIDE**  
 Airplanes AF49-2897 through -2981

Figure 1-24

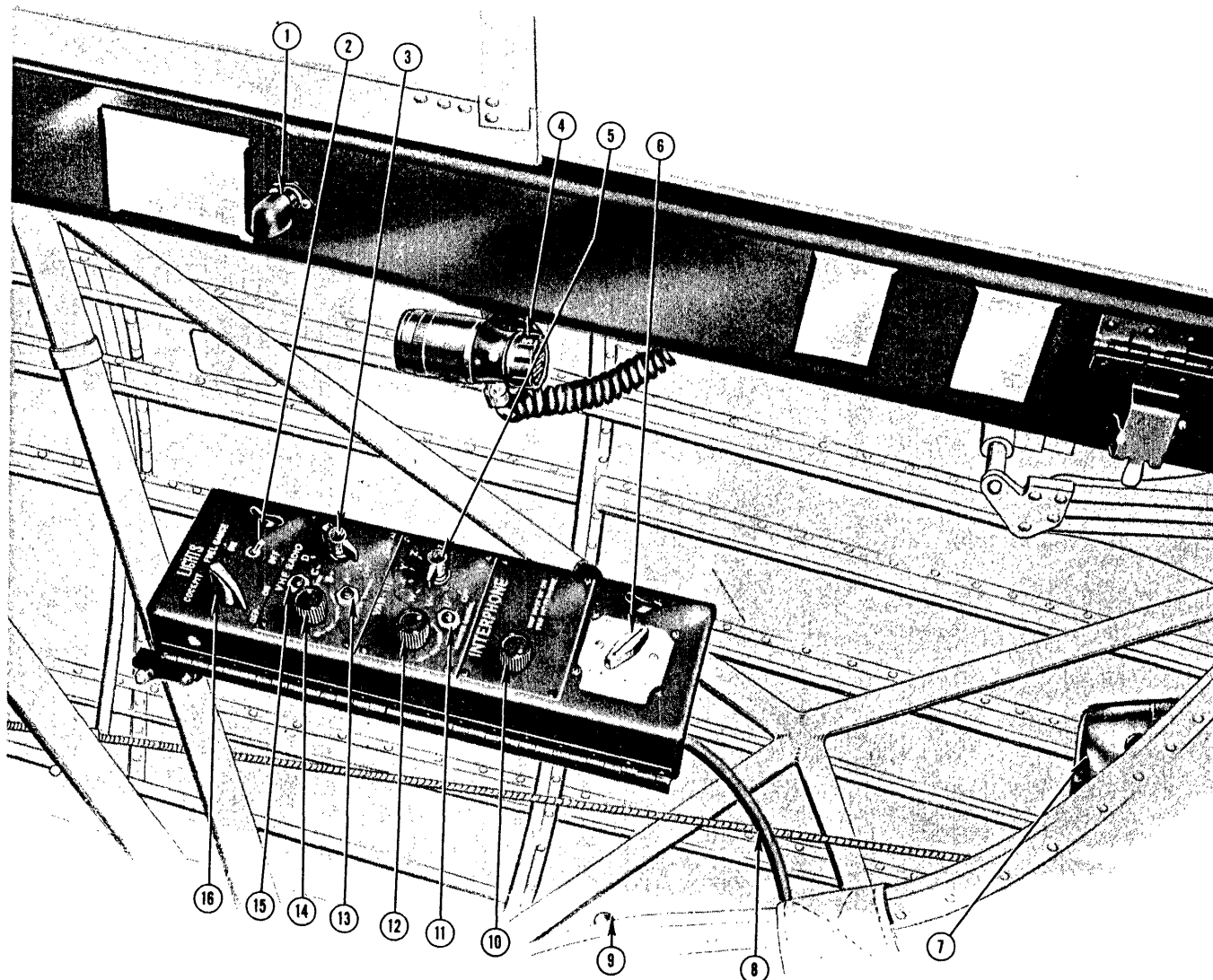

- |   |   |
|---|---|
| <b>1. COCKPIT LIGHT</b>                     | <b>9. SEAT ADJUSTMENT LEVER</b>             |
| <b>2. FUEL GAGE LIGHT SWITCH</b>            | <b>10. INTERPHONE VOLUME CONTROL KNOB</b>   |
| <b>3. VHF RADIO CHANNEL SELECTOR SWITCH</b> | <b>11. ILS CONTROL TRANSFER PUSH BUTTON</b> |
| <b>4. FLUORESCENT LIGHT CONTROL KNOB</b>    | <b>12. ILS VOLUME CONTROL KNOB</b>          |
| <b>5. ILS CHANNEL SELECTOR SWITCH</b>       | <b>13. VHF CONTROL TRANSFER PUSH BUTTON</b> |
| <b>6. RADIO RANGE FILTER SWITCH</b>         | <b>14. VHF RADIO VOLUME CONTROL KNOB</b>    |
| <b>7. FIRST-AID KIT</b>                     | <b>15. D/F TONE PUSH BUTTON</b>             |
| <b>8. RADIO EARPHONE CORD</b>               | <b>16. COCKPIT LIGHT RHEOSTAT</b>           |

## Rear cockpit

RIGHT SIDE

Airplanes AF49-2982 through -3537,  
AF50-1277 through -1326, AF51-15138  
through -15237, and -16071 through  
-16077

16R-00-1087A

Figure 1-25

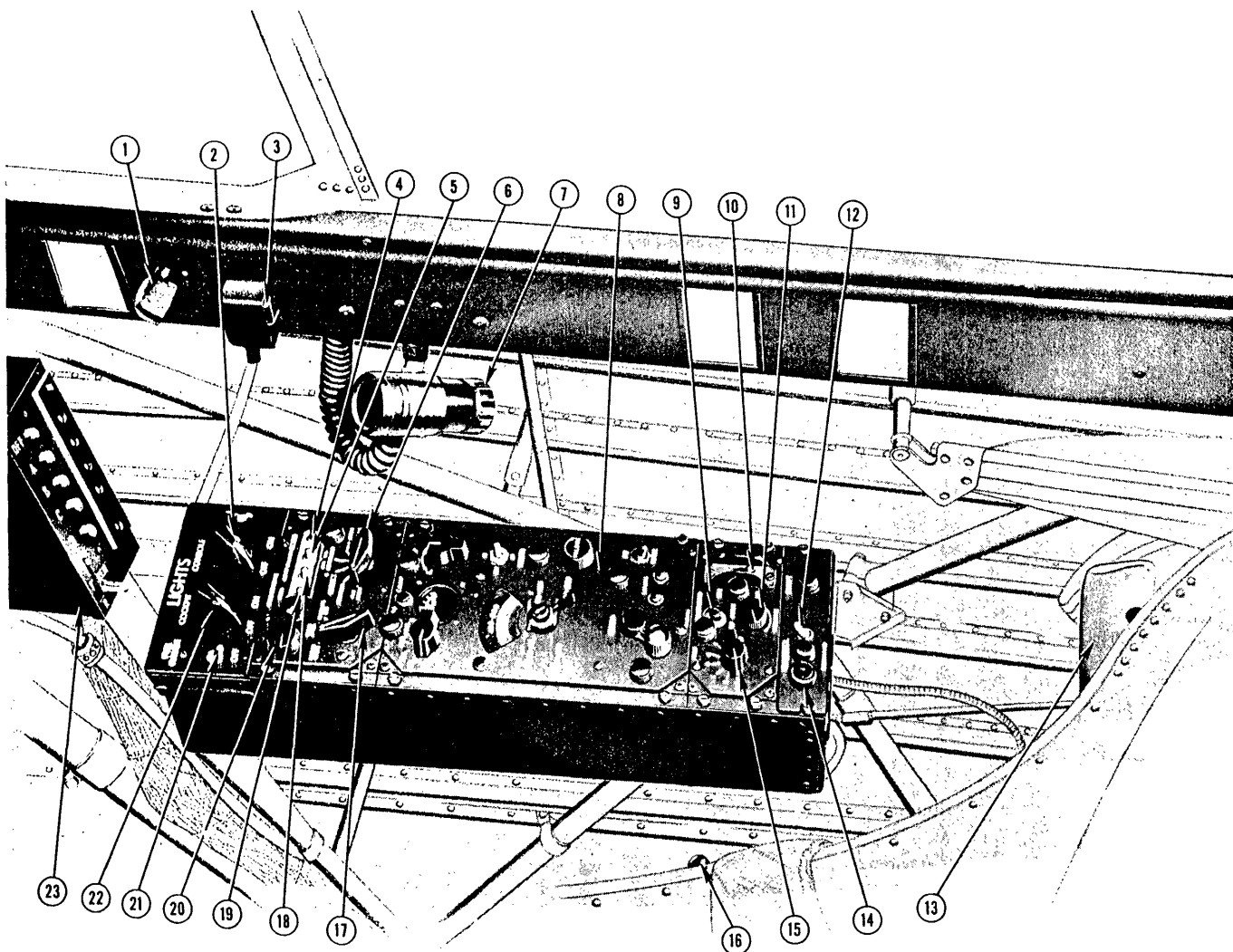

- |  |  |
|--|--|
| <b>1. COCKPIT LIGHT</b>                                    | <b>13. FIRST-AID KIT</b>                                   |
| <b>2. CONSOLE LIGHT RHEOSTAT</b>                           | <b>14. VHF CONTROL INDICATOR LIGHT<br/>(DISCONNECTED*)</b> |
| <b>3. MICROPHONE JACK</b>                                  | <b>15. VHF CHANNEL SELECTOR SWITCH†</b>                    |
| <b>4. LOCALIZER SWITCH (DISCONNECTED)</b>                  | <b>16. SEAT ADJUSTMENT LEVER</b>                           |
| <b>5. MARKER BEACON SWITCH<br/>(DISCONNECTED*)</b>         | <b>17. RADIO RANGE FILTER SWITCH</b>                       |
| <b>6. MASTER SELECTOR SWITCH</b>                           | <b>18. RADIO COMPASS SWITCH</b>                            |
| <b>7. FLUORESCENT LIGHT CONTROL KNOB</b>                   | <b>19. INTERPHONE SWITCH (DISCONNECTED*)</b>               |
| <b>8. RADIO COMPASS CONTROL PANEL</b>                      | <b>20. MASTER VOLUME CONTROL KNOB</b>                      |
| <b>9. D/F TONE PUSH BUTTON‡</b>                            | <b>21. FUEL GAGE LIGHT SWITCH</b>                          |
| <b>10. VHF POWER SWITCH‡</b>                               | <b>22. COCKPIT LIGHT RHEOSTAT</b>                          |
| <b>11. VHF AUDIO CONTROL KNOB‡</b>                         | <b>23. VHF RADIO CONTROL PANEL*</b>                        |
| <b>12. VHF CONTROL TRANSFER SWITCH<br/>(DISCONNECTED*)</b> |  |

\*Airplanes AF51-14359 through -14683

†Airplanes AF51-14314 through -14358, -14684 through -15137, and -17354 and subsequent

**Rear cockpit**

RIGHT SIDE

Airplanes AF51-14314 through -15137,  
and -17354 and subsequent

168-00-1088C

Figure 1-26

**CANOPY.**

The canopy has two sliding sections, one over each cockpit, which are controlled separately by handles on the exterior and interior. The front sliding section can be locked at four positions: open, closed, and two intermediate positions. The rear sliding section can be locked at three positions: open, closed, and an intermediate position. Both side panels (figure 3-5) on each sliding section can be forcibly pushed out free from the canopy to provide an emergency exit from the airplane.

**SEATS.**

The seats are adjusted by means of a seat adjustment lever (17, figure 1-18; 9, figure 1-24) at the right side of each seat. Pulling the lever back allows the seat to be raised or lowered. When the lever is pulled, the occupant is assisted in raising the seat by a bungee cord which tends to pull the seat up. A seat cushion is provided in each seat.

**SHOULDER HARNESS INERTIA REEL LOCK HANDLE.**

A two-position (locked and unlocked) shoulder harness inertia reel lock handle (21, figure 1-17; 20, figure 1-23) is located on the left side of each seat. A latch is provided for positively retaining the handle at either position of the quadrant. When the top of the handle is pressed down, the latch is released and the handle may be moved freely from one position to another. In addition to provisions for manually locking the shoulder harness, the inertia reel will automatically lock the shoulder harness when a 2 to 3 G deceleration is applied on the airplane as in a crash landing. Consequently, it is necessary to manually lock the shoulder harness only

during maneuvers and flight in rough air, or as an added precaution in event of a forced landing. Pulling on the shoulder harness will not operate the inertia reel.

If the harness is locked while the pilot is leaning forward, as he straightens up, the harness will retract with him, moving in successive locked positions as he moves back against the seat. To unlock the harness, the pilot must be able to lean back enough to relieve the tension on the lock. Therefore, if the harness is locked while the pilot is leaning back hard against the seat, he may not be able to unlock the harness without first releasing it momentarily at the safety belt (or releasing the harness buckles, if desired). After automatically locking, the harness will remain locked until the lock handle is moved to the locked position and then back to the unlocked position.

**CAUTION**

All switches not readily accessible with the harness locked should be properly positioned before the harness lock handle is moved forward to the locked position.

**AUXILIARY EQUIPMENT.**

Section IV contains all information pertaining to the description and operation of auxiliary equipment. Included in Section IV are the heating and ventilating systems, communication and associated electronic equipment, lighting equipment, and miscellaneous equipment.

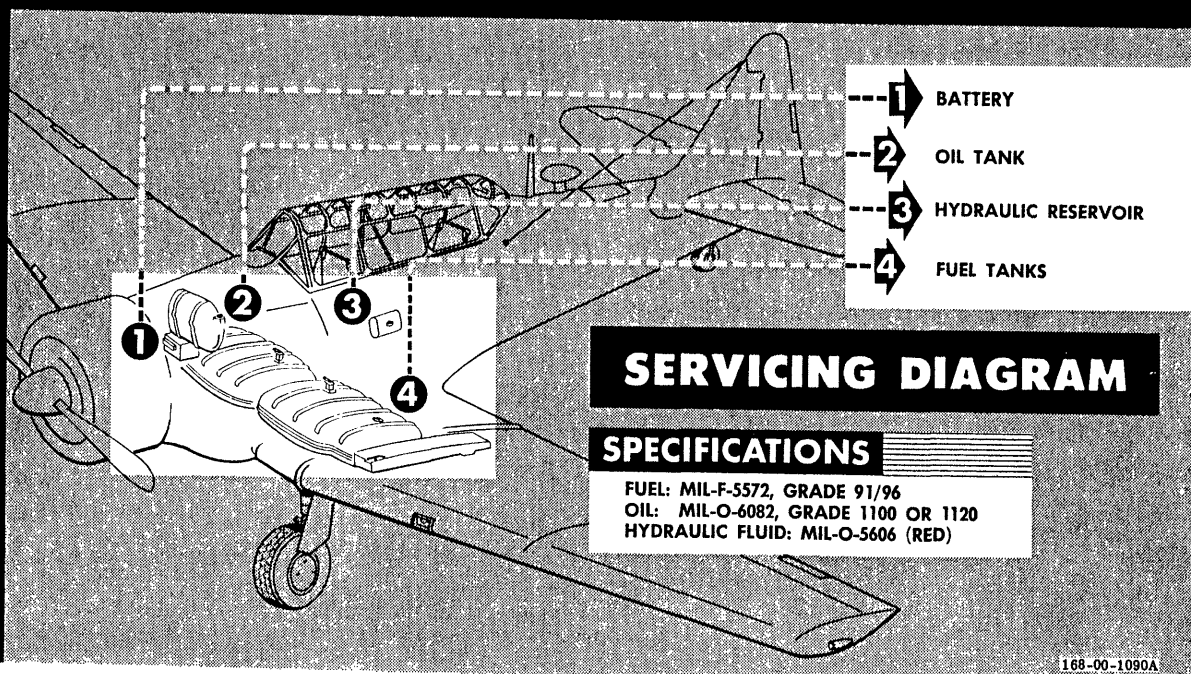
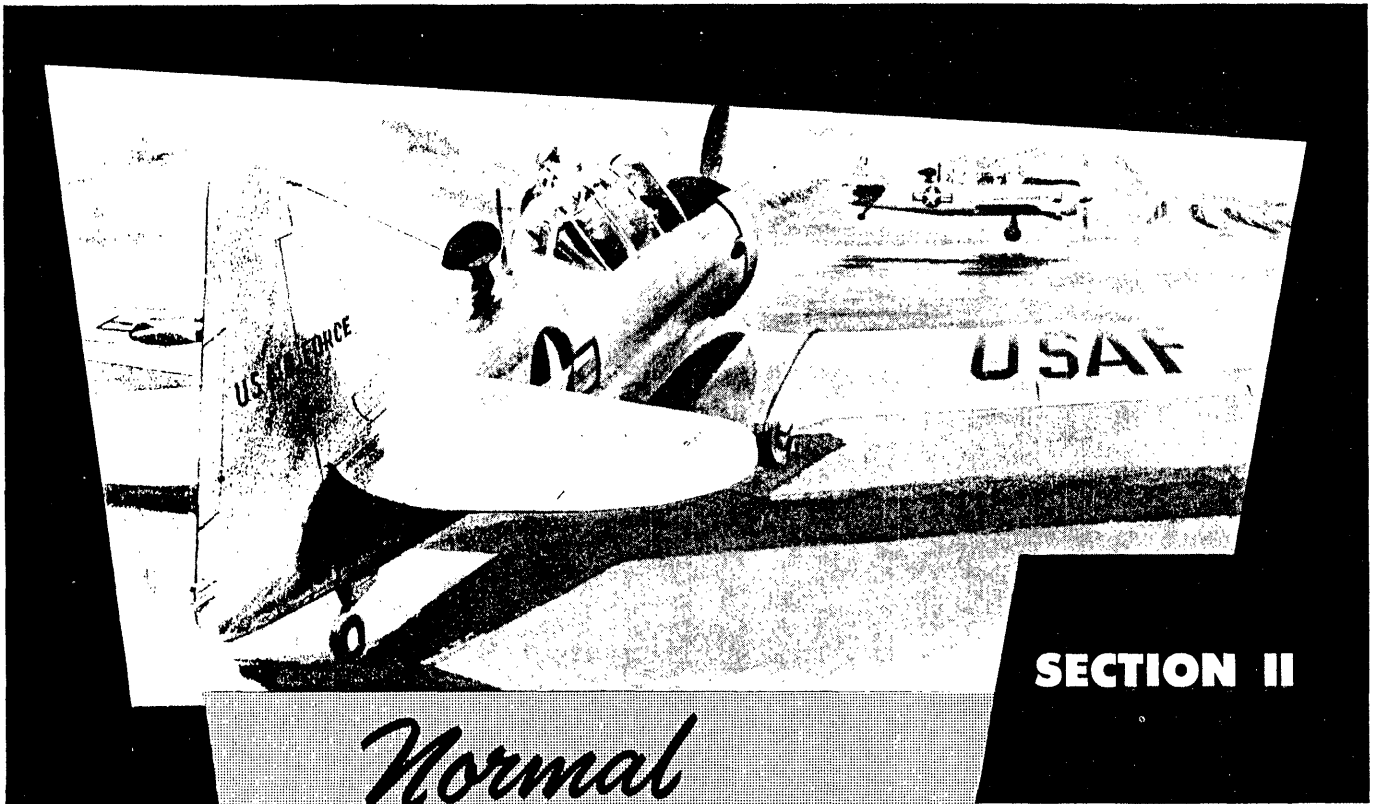

Figure 1-27



## SECTION II

# Normal Procedures



### BEFORE ENTERING THE AIRPLANE.

#### FLIGHT RESTRICTIONS.

Detailed airplane and engine limitations are listed in Section V.

#### PREFLIGHT PLANNING.

From the operating data contained in the Appendix, determine fuel consumption, correct airspeed, and power settings as necessary to accomplish the intended mission. The Appendix data will enable you to properly plan your flight so that you can obtain the best possible performance from the airplane.

#### WEIGHT AND BALANCE.

Refer to Section V for weight and balance limitations. Refer to Handbook of Weight and Balance Data (AN 01-1B-40) for loading. Before each mission, make the following checks:

1. Check take-off and anticipated landing gross weight and balance.
2. Make sure fuel, oil, and special equipment carried is sufficient for the mission to be accomplished.
3. Make sure weight and balance clearance (Form F) is satisfactory.

#### EXTERIOR INSPECTION.

Make an exterior inspection, starting at the front cockpit and going clockwise around the airplane. See figure 2-1 for complete inspection procedure. 

#### Note

The cockpits are accessible from the left side of the airplane only. To open canopy, pull up on canopy handle and slide front cockpit section aft and rear cockpit section forward.

#### ON ENTERING THE AIRPLANE.

##### INTERIOR CHECK (ALL FLIGHTS).

Make the following checks before starting the engine:

1. Check rear cockpit for presence of first-aid kit.
2. Fill out Form 1.
3. Unlock flight controls and check for free and correct movement.
4. Fasten safety belt and shoulder harness. Check manual operation of shoulder harness lock.
5. Adjust seat and rudder pedals.
6. Set parking brakes and adjust headset.

# EXTERIOR INSPECTION

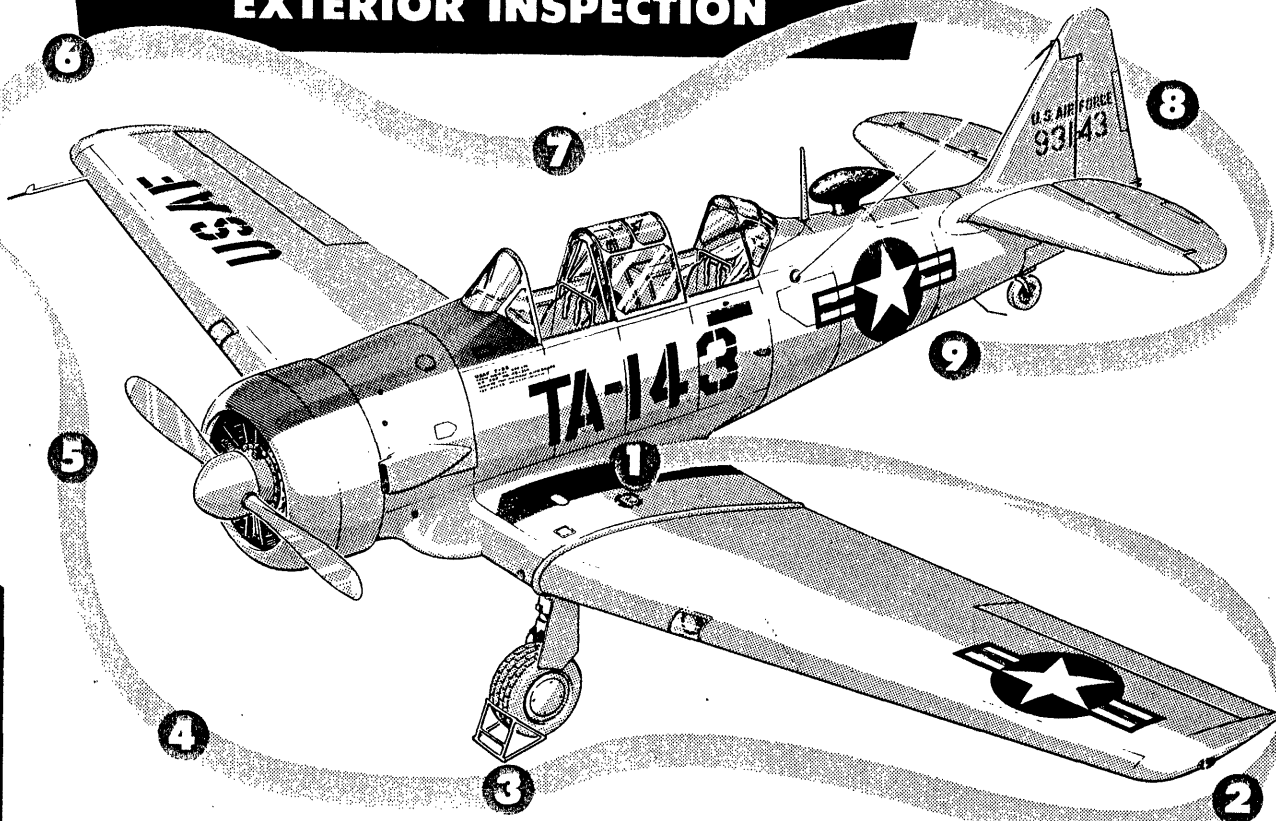

**NOTE:** During this preflight check, inspect entire exterior for wrinkles, loose rivets, dents, and loose access doors.

Starting at the front cockpit, make the following checks:

## 1 COCKPIT

Ignition and battery-disconnect switches **OFF**.  
Check Form 1.

Verify that airplane has been serviced with required quantities of fuel, oil, and hydraulic fluid.

Oil and hydraulic caps secure.

Controls locked and trim tabs neutral.

Wing flap handle and related indicator up.

If flying solo, rear cockpit control stick stowed and safety belt, shoulder harness, microphone, headset, and canopy secured. On early airplanes,\* be sure the vhf and ILS control transfer switches are in the front position.

## 2 LEFT WING

Visually check fuel quantity.

Check wing flaps for full up position.

Aileron and trim tab neutral and hinges secure.

Condition of navigation light and wing tip.

## 3 LEFT LANDING GEAR

Condition of landing light, downlock light, torque linkage, and uplock.

Wheel chocked.

Extension of gear strut (one to 2 inches).

Tire for proper inflation, condition, and slippage.

Hydraulic leaks.

## 4 POWER PLANT SECTION

Propeller free of nicks and oil leaks.

Condition of cowl light.

Cowling secure and free of foreign objects.

Carburetor air and oil cooler scoops clear.

## 5 RIGHT LANDING GEAR

Same as opposite side.

## 6 RIGHT WING

Same as opposite side.

Pitot head cover removed.

## 7 FUSELAGE RIGHT SIDE

Condition of vhf mast and radio compass loop.

## 8 EMPENNAGE

Rudder, elevators, and respective trim tabs neutral, and hinges secure.

Condition of navigation lights.

Extension of tail wheel strut (approximately 6 inches from top of tire to bottom of fuselage).

Tire for proper inflation, condition, and slippage.

Grounding wire secure.

## 9 FUSELAGE LEFT SIDE

Baggage and loose equipment secured if carried.

Baggage compartment locked and closed.

Fire extinguisher serviceable.

\*AF49-2897 through -2981

168-00-1091A

Figure 2-1

7. Check fuel quantity gages. Fuel selector 70 GAL LEFT.

**Note**

Steps for starting engine and subsequent ground operation include checking all positions of the fuel selector.

8. Wing flap handle UP. Check flap position indicator.

9. Landing gear handle DOWN. Check gear position indicator.

10. Temporarily place navigation light and battery disconnect switches on to check landing gear downlock indicator lights.

11. Check emergency landing gear downlock handle full forward.

12. Carburetor air control COLD.

13. Radio compass switch OFF.

14. Manifold pressure drain valve handle CLOSED.

15. Check generator switch ON.

16. Check gyro switch ON.

17. Check all remaining switches at OFF.

18. Circuit breakers in.

19. Altimeter, accelerometer, and clock set.

20. Gyros UNCAGED.

**Note**

The gyro instruments should be uncaged at all times except during maneuvers that exceed operating limits. If gyro horizon bar is not level after engine is started, cage and uncage the gyro 5 minutes before take-off.

21. Note manifold pressure reading (field barometric pressure) for subsequent use during engine power check.

22. Communications equipment off and related circuit breakers in.

23. Adjust cockpit air temperature control valves as desired.

**INTERIOR CHECK (NIGHT FLIGHTS).**

If night flying is anticipated, the following additional checks should be made:

1. Have external power source connected. To prevent unnecessary discharge of battery, leave battery-disconnect switch OFF unless external power is not available.

2. With the aid of outside observer, test operation of navigation, passing, landing, and cowl lights. Check that landing gear downlock lights are illuminated.

3. Check operation of cockpit (fluorescent and incandescent), fuel quantity gage, and compass lights.

4. Push to test and adjust intensity of all indicator and warning lights.

5. Check for reliable flashlight on board.

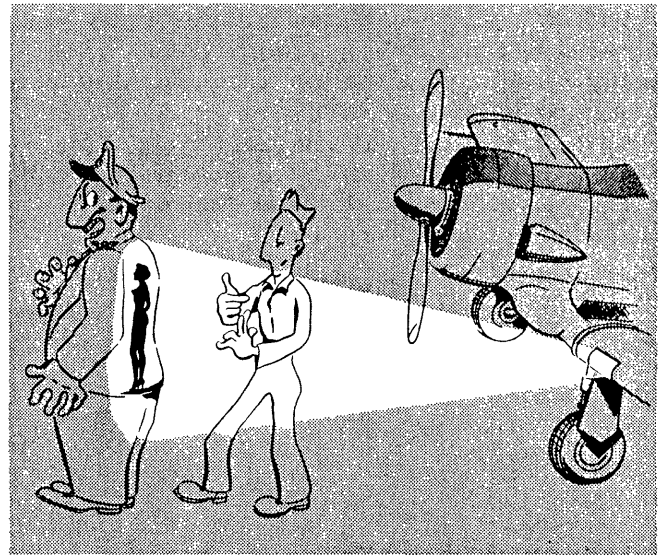

*Do not leave landing, passing, or recognition lights on for more than 10 seconds when airplane is on the ground, as excess heat may seriously damage the light.*

**STARTING ENGINE.**

Start the engine as follows:

1. Check that propeller has been pulled through at least two revolutions.
2. Post fire guard and check propeller clear.
3. Throttle open approximately 1/2 inch.
4. Mixture control full RICH.
5. Check propeller control full DECREASE.

**CAUTION**

Since engine is normally shut down with propeller at decrease rpm, it must be started with propeller in same position so that full oil pressure will be available for engine lubrication during starting.

6. Unlock primer and operate 3 or 4 strokes to fill primer lines.

**Note**

Operation of primer to fill primer lines will eliminate excessive cranking when starting engine.

7. Call, "Switches on!"

8. Have external power source connected. To prevent unnecessary discharge of battery, leave battery-disconnect switch OFF unless external power is not available.



9. Call, "Clear?" and wait for assurance from ground crew before actuating starter switch pedal. After the propeller turns over about two revolutions, turn ignition switch to BOTH.

10. Operate primer with slow, even strokes until the engine starts firing. If necessary, continue priming until engine runs smoothly. Lock primer. Do not prime a hot engine.



*Do not use the hand fuel pump when starting engine, as fire may occur if engine backfires.*

11. As the engine starts, release starter switch pedal.

**Note**

Should a backfire result, retard the throttle slightly. Do not pump the throttle.

12. Adjust throttle to obtain 500 to 600 rpm as quickly as possible.

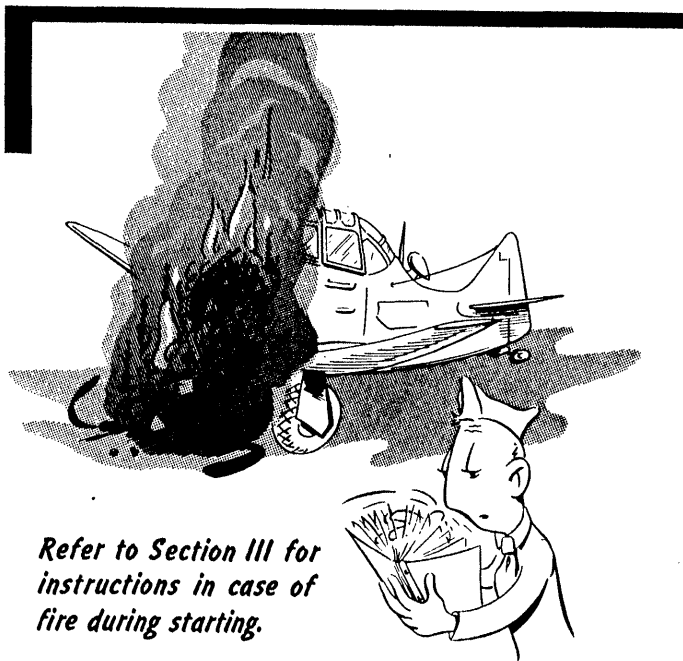

*Refer to Section III for instructions in case of fire during starting.*

13. Check oil pressure; if gage does not indicate 40 psi within 30 seconds, stop the engine and investigate.

14. Have external power supply disconnected and turn battery-disconnect switch ON.

15. Check operation of pitot heater with aid of ground crew.

**WARM-UP PROCEDURE.**

1. As soon as oil pressure indicates 40 psi, propeller control full INCREASE.

2. Throttle adjusted to obtain the smoothest rpm between 1200 to 1400 rpm for warm-up.

3. VHF radio turned to proper channel.

4. Fuel selector 70 GAL RIGHT.

5. Check generator cutin at approximately 1250 rpm and cutout at approximately 1000 rpm.

**GROUND TESTS.**

While the engine is warming up, perform the tests outlined in figure 2-2.

**TAXIING INSTRUCTIONS.**

Primary controls for taxiing the airplane are the throttle, steerable tail wheel, and brakes. Coordinate these controls for easy taxiing. Observe the following instructions and precautions for taxiing:

1. Have chocks pulled, allow airplane to roll forward slightly, and check the brakes.

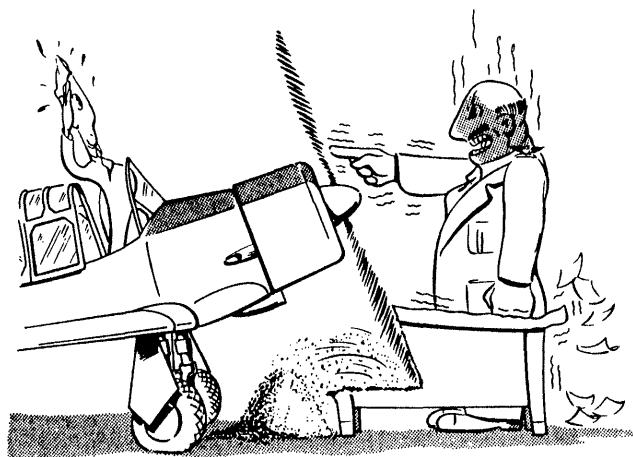

*Never allow taxi speed to build up before checking brakes.*

2. The tail wheel, being steerable by use of the rudder pedals, provides ample control of the airplane under all normal taxiing conditions.

3. To make sharp turns, slow the airplane down, position control stick full forward to disengage tail wheel, and use the brakes to control the airplane. Never allow the inside wheel to stop during a turn. Turning with one wheel stopped may damage the wheel, tire, or strut.



Hydraulic system—check as follows: Lower flaps and check hydraulic pressure gage for normal pressure. Raise flaps in increments to check **LOCK** position. (Flaps should not creep when wing flap handle is in this position.)

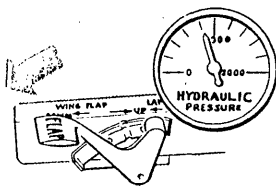

With manifold pressure below 30 in. Hg, open manifold pressure gage drain valve for 3 seconds.

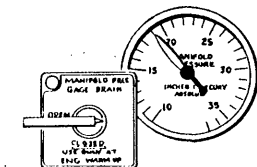

Carburetor air control—check operation. Note drop in manifold pressure with increase in mixture temperature.

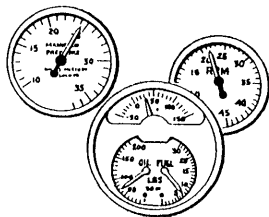
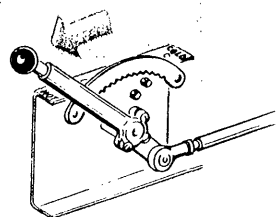

Instruments—check for readings in desired ranges.

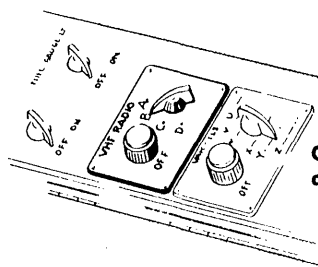

Communications equipment—check operation.

Ignition switch—check at 700 rpm, turn ignition switch **OFF** momentarily. If engine does not cease firing completely, shut down engine and warn personnel to remain clear of the propeller.

### CAUTION

Perform this check as rapidly as possible to prevent severe backfire when ignition switch is returned to **BOTH**.

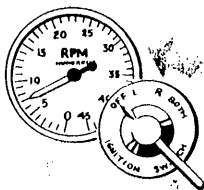

168-00-1092A

Figure 2-2. Ground Tests

4. The throttle is the main taxi speed control, and most taxiing can be accomplished with it in the closed or slightly open position. Brake usage should be kept to a minimum.

5. Tail wheel engaged. To engage the tail wheel for steering, the tail wheel and rudder must be aligned and the control stick must be back from full forward position. Alignment can be readily accomplished by allowing the airplane to roll forward slightly with the rudder neutral.

### Note

Because of restricted forward visibility, S-turn the airplane well to both sides of the desired track to provide a clear, unrestricted view.

### UPWIND TAXIING.

The stick should be held fully aft to hold the tail of the airplane on the ground and to ensure positive steering action of the tail wheel.

### DOWNWIND TAXIING.

The stick should be held forward to keep the tail from lifting off the ground because of wind pressure being built up beneath the elevators.

### Note

If the stick is *full* forward, the tail wheel will free-swivel.

### CROSS-WIND TAXIING.

Hold stick into the wind to keep wings level. The primary means of airplane control will be by use of rudder, which is adequate even in extremely strong winds. If necessary, a slight amount of downwind brake may be used but should be held to a minimum.

### BEFORE TAKE-OFF.

After taxiing to run-up position, face into the wind and hold brakes; then make the following airplane and engine checks.

### PREFLIGHT AIRPLANE CHECK.

#### 1. Primary Controls:

Check surface controls for free and proper movement.

#### 2. Instruments and Switches:

Altimeter set.

Directional gyro set.

Gyro horizon set.

All instrument readings in desired ranges.

All switches at desired positions.

#### 3. Fuel System:

Fuel selector on 70 GAL LEFT or 70 GAL RIGHT, whichever contains more fuel. Refer to Section VII for instructions concerning fuel selection during flight.

Mixture control full RICH.

Primer locked.

## 4. Flaps:

Flaps set for take-off (UP for normal take-off).

## 5. Trim:

Trim tabs set for take-off (elevator—11 o'clock, rudder—2 o'clock).

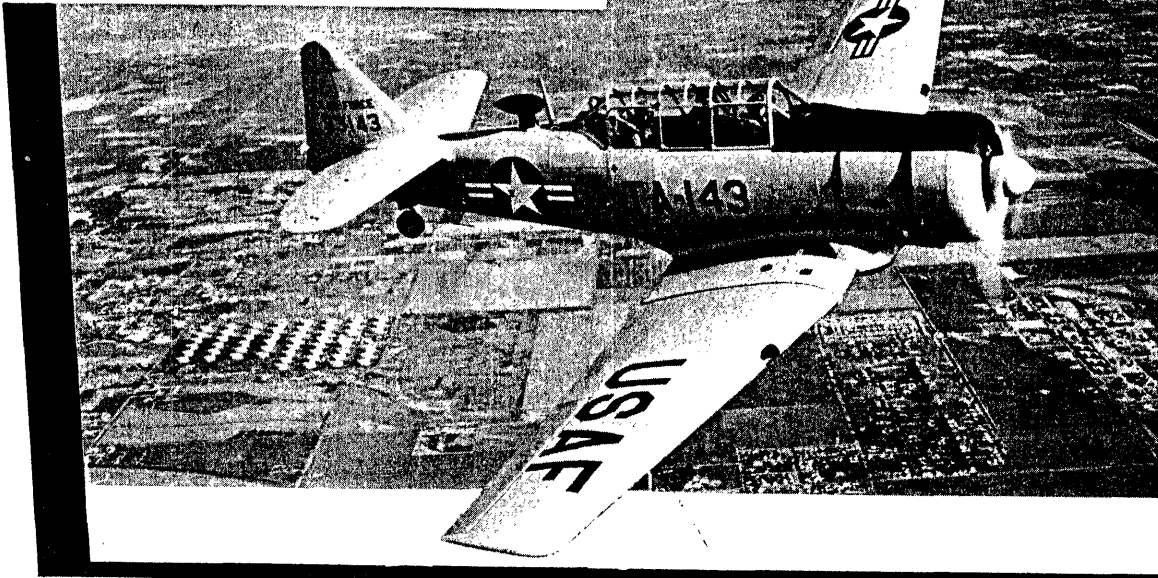

## PREFLIGHT ENGINE CHECK.

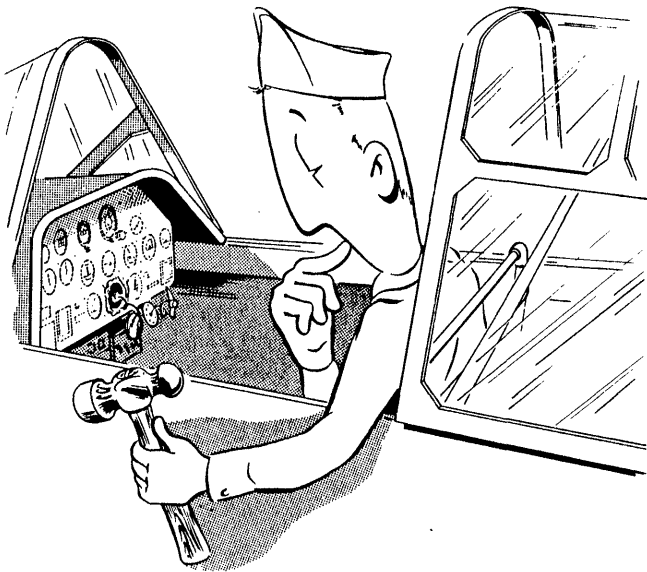

*While performing checks requiring rpm reading, tap the instrument panel to prevent tachometer sticking.*

1. Check propeller control at full INCREASE.

2. Propeller check—at 1600 rpm, pull propeller control back to full DECREASE position and note drop of approximately 200 rpm; then return control to full INCREASE position.

3. Power check—adjust manifold pressure to field barometric pressure (as read on manifold pressure gage before starting engine) and check for 2000 ( $\pm 50$ ) rpm.

**Note**

If less than the prescribed rpm is obtainable for given manifold pressure, engine is not developing sufficient power and should be corrected before flight.

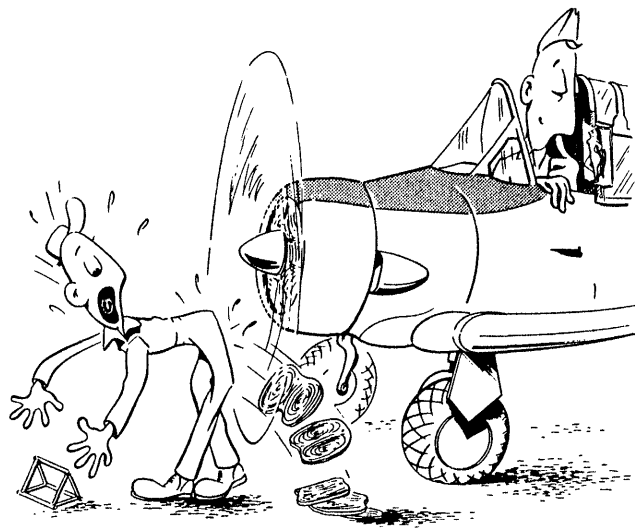

*When running engine up to high power, be careful to have stick back and brakes applied.*

4. Ignition system check—with throttle adjusted to 2000 rpm, position ignition switch to L and R and, in each position, check for maximum drop of 100 rpm. The absence of *any* rpm drop indicates that the opposite magneto is not being electrically grounded during the test as it should be. Between checks, return ignition switch to BOTH to allow speed to stabilize. If drop exceeds 100 rpm, return ignition switch to BOTH and run engine up to Take-off Power for a few seconds to clear spark plugs; then recheck ignition system at 2000 rpm. Return ignition switch to BOTH at completion of test.

#### Note

During the test, observe the ring cowl for excessive vibration; a faulty ignition wire or one or more bad spark plugs will cause the cowl to vibrate excessively.

5. Cruising fuel-air mixture check—with propeller control at full INCREASE and mixture control full RICH, allow engine speed to stabilize at 1900 rpm. Move mixture control into the manual leaning range until an approximate 100 rpm drop is noted; then return to RICH. The engine speed should increase very slightly before it decreases. An immediate decrease indicates the mixture is set too lean. A momentary increase in excess of 25 rpm indicates the mixture is set too rich.

6. Idle speed check—with throttle against the idle stop, the engine should idle at 450 rpm.

7. Acceleration and deceleration check—with the mixture control at RICH, advance throttle from idle to 2000 rpm. Engine should accelerate and decelerate smoothly with no tendency to backfire.

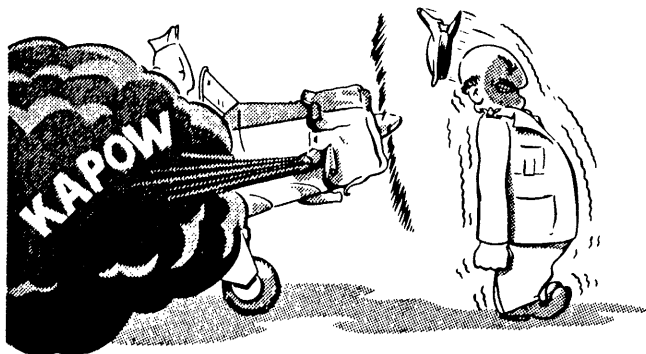

*Rapid reversal or sudden throttle movements must be avoided.*

8. Carburetor air control full COLD.

#### TAKE-OFF.

Plan your take-off according to the following variables affecting take-off technique: gross weight, wind, outside air temperature, altitude of field, type of runway, and height and distance of the nearest obstacles. See figure A-4 for required take-off distances.

#### NORMAL TAKE-OFF.

In order to perform a take-off within the distance specified in the Take-off Distances chart (figure A-4), the following procedure must be used:

1. Visually check final approach for aircraft; then roll into take-off position and line up airplane with runway.
2. Canopy locked open for improved visibility and to permit immediate escape in case of sudden emergency.
3. Tail wheel engaged for steering.
4. Advance throttle smoothly to Take-off Power.
5. Use elevator control to permit the airplane to assume a tail low attitude for take-off. With proper trim setting for the load condition, the elevator will be in an approximately neutral position.
6. Allow the airplane to fly itself off the ground, using only slight back pressure on the control stick.
7. Normal take-off speed is approximately 80 mph.

#### Note

For procedure to follow if engine fails during take-off, refer to Section III.

#### MINIMUM-RUN TAKE-OFF.

A minimum-run take-off is a maximum performance maneuver with the airplane near stalling speed. It is directly related to slow flying and flaps-down stalls; consequently, you should be familiar with these maneuvers before attempting to make a minimum-run take-off. Complete all normal "before take-off" checks and follow the procedure outlined in figure 2-3 for a minimum-run take-off.

#### CROSS-WIND TAKE-OFF.

The following procedure is recommended for cross-wind take-off:

1. Advance throttle to Take-off Power setting and maintain directional control with rudder.
2. Continue as in a normal take-off, applying sufficient aileron into the wind pressure to maintain wing level attitude, or even enough aileron to effect a slight wing-low-into-the-wind take-off. Care must be taken to compensate for the added effectiveness of the aileron control as airspeed increases.
3. As airspeed increases, compensate for the increase in aileron effectiveness and perform a normal take-off with a slight wing-low-into-the-wind attitude.
4. After becoming air-borne, counteract drift by making a coordinated turn into the wind.

#### NIGHT TAKE-OFF.

Night take-off procedure is the same as for daylight operation. However, a thorough knowledge of switch and light location is essential. The following additional checks are recommended for night take-off:

1. Turn cockpit lights low.
2. Tune radio carefully and loud, as it will fade during take-off and flight.
3. Hold airplane steady on a definite reference point during the take-off run.
4. Don't be alarmed by exhaust flame.

**AFTER TAKE-OFF.**

1. When the airplane is definitely air-borne, move landing gear handle to UP. Approximately 15 seconds is required for gear retraction.

2. Reduce engine output to Maximum Continuous Power by first retarding throttle, then propeller control.

**Note**

For training purposes, reduce power to 30 in. Hg manifold pressure at 2000 rpm.

3. Establish a constant climb attitude.

**CLIMB.**

1. Advance throttle to maintain manifold pressure during climb.

**Note**

For training purposes, maintain 110 mph, 30 in. Hg manifold pressure, and 2000 rpm.

2. Close canopy upon reaching 3000 feet, and lean mixture for smooth operation.

3. Refer to Normal Power Climb chart (figure A-5) for climb data power settings, recommended airspeed, rate of climb, and fuel consumption.

**FLIGHT CHARACTERISTICS.**

All data on flight characteristics is incorporated in Section VI.

**SYSTEMS OPERATION.**

Information pertaining to use of Take-off Power, manual leaning of carburetor mixture, propeller operation, carburetor icing, detonation, preignition, and fuel system operation is included in Section VII. Other special operating techniques may be added to this section as required.

**DESCENT.**

Descending with throttle closed and gear and flaps up, the airplane can cover long distances with a comparatively small loss of altitude. Lowering either the flaps or landing gear greatly steepens the gliding angle and increases the rate of descent. Before entering a descent, close throttle and move mixture control toward RICH to provide smooth engine operation at the reduced rpm. Because the engine cools rapidly during a descent with the throttle retarded, clear the engine approximately every 30 seconds by advancing the throttle slowly and smoothly to 25 in. Hg manifold pressure to prevent fouled plugs.

**CAUTION**

Do not allow cylinder head temperature to drop below 100°C during descent.

For training purposes, the following should be accomplished.

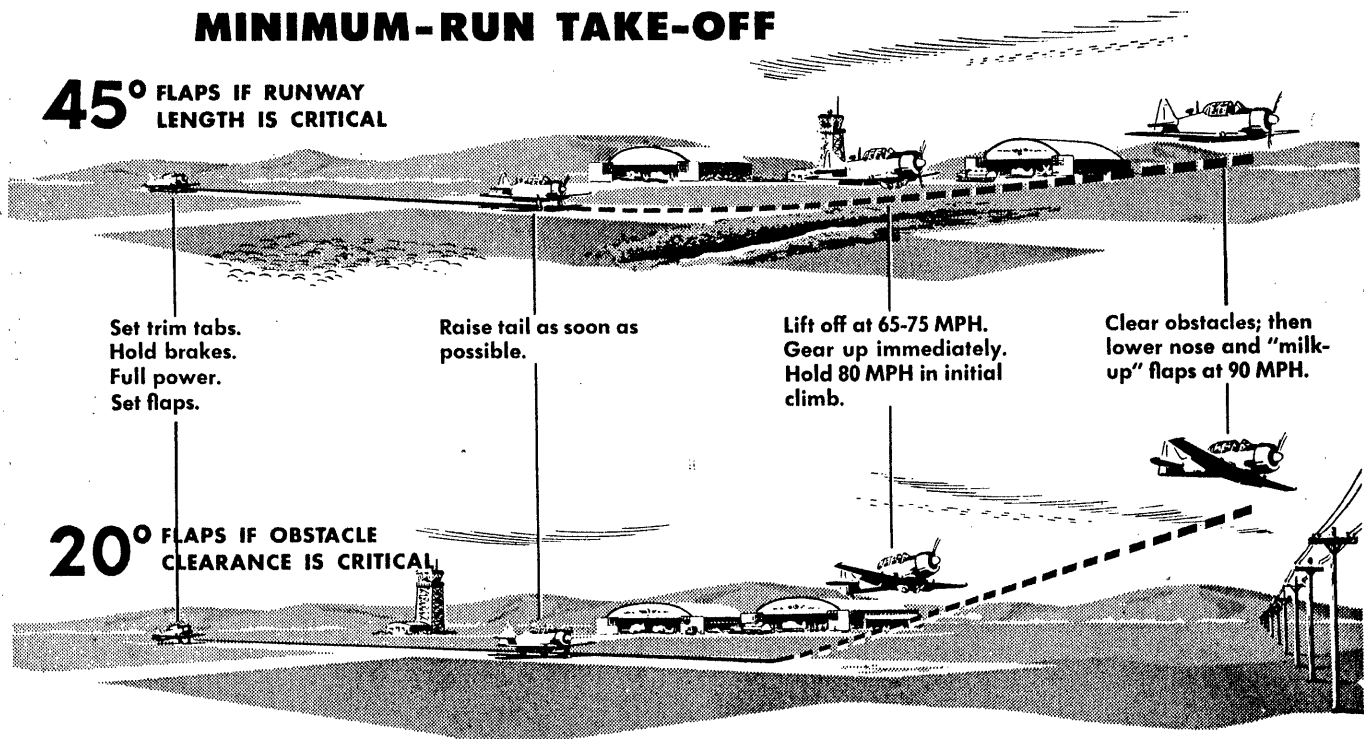
**MINIMUM-RUN TAKE-OFF**

168-00-1110

Figure 2-3



1. Open canopy as a safety precaution upon reaching 3000 feet.
2. Mixture control full RICH to prevent engine roughness and possible cutout during descent.

#### TRAFFIC PATTERN CHECK LIST.

Traffic pattern procedure and check list are shown in figure 2-4.

#### LANDING.

##### FINAL APPROACH AND TOUCHDOWN.

In order to obtain the results stated in the Landing Distances chart (figure A-6), accomplish the approach and landing procedures outlined in figure 2-4. In addition, observe the following precautions and techniques: Just before reaching end of runway, start flare. Use smooth, continuous back pressure on the stick to obtain a tail-low attitude for landing. Change attitude evenly and slowly; don't jerk the control or go down in steps. Note that the attitude for this landing is similar to that attained in a gear- and flaps-down stall. Touch down in three-point attitude. The ailerons are only partially effective at low speeds but can still be used advantageously during the round-out and touchdown. Since the vertical stabilizer is offset to the left almost 2 degrees to counteract propeller torque at cruising speeds, a slight amount of left rudder pressure should be applied throughout the round-out and touchdown to prevent swerving to the right when landing in calm wind or straight into the wind. After touchdown, hold the stick back to help keep the tail down for positive tail wheel steering. Refer to Section III for information regarding emergency landings.

##### LANDING ROLL.

Since most landing accidents in this airplane occur during the landing roll, it is during this operation that you must be extremely alert. Immediately on touchdown, the airplane might swerve suddenly or skip on the runway. This sudden swerve is sometimes caused by landing in a slight drift or skid. Use ailerons as necessary to counteract a wing-low condition. Remain alert for a tendency to swerve to the right. When possible, take

advantage of runway length to save brakes. Test brakes carefully before their use becomes a necessity, and apply them soon enough to avoid abrupt braking action. Since the rudder, which is the main directional control, will be less effective as you slow down, you must be particularly alert as you near the end of the landing roll.

##### CROSS-WIND LANDING.

Use aileron-into-the-wind, opposite rudder (wing-low) method of landing in a cross wind.

1. Allow for drift while turning on final approach so that you won't overshoot or undershoot the approach leg.
2. Establish drift correction on final approach by lowering the wing into the wind, using opposite rudder to maintain the longitudinal axis parallel with the runway, as soon as drift is detected.
3. Velocity and direction of the wind will determine the amount of flaps used for the landing.

##### Note

Since an airplane acts like a weather vane, it attempts to swing into the wind. Flaps increase this weather-vaning tendency, so use a minimum degree of flaps in a cross wind.

4. Maintain aileron into the wind with opposite rudder for drift correction throughout the round-out, touch-down, and landing roll, compensating for the loss of effectiveness of the aileron as airspeed decreases by applying additional aileron into the wind. Actual touch-down will be two-point, upwind main gear and tail wheel.

# APPROACH AND LANDING PROCEDURE

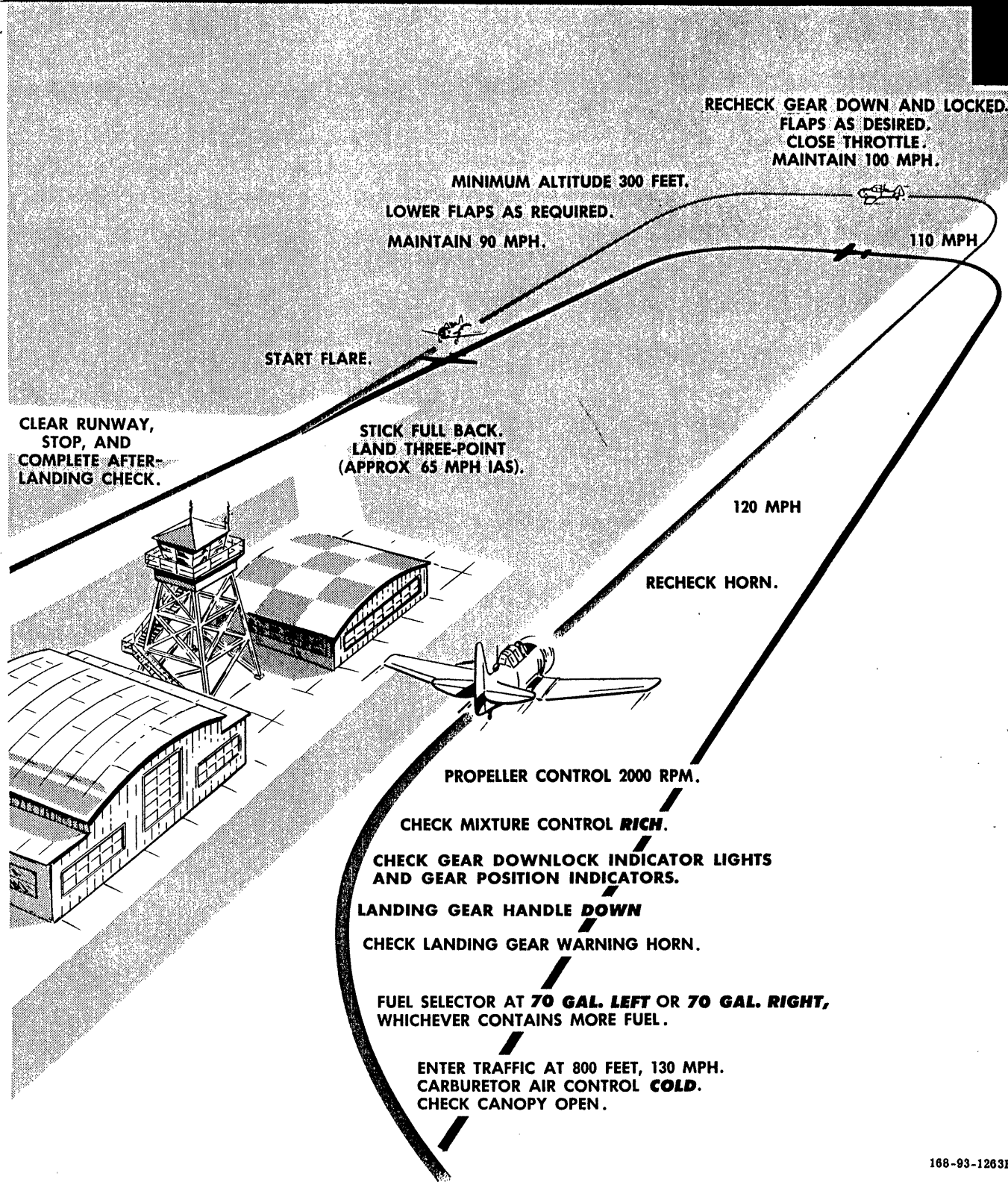

168-93-1263B

Figure 2-4

Revised 30 January 1953

**NIGHT LANDING.**

The same techniques and procedures used for day landings will be applied. Don't turn on the landing lights at too high an altitude and avoid using them at all if landing in fog, smoke, or thick haze, as reflection from the lights impedes vision and may distort depth perception. Alternate the use of landing lights while taxiing after landing.

**GO-AROUND.**

A typical go-around procedure is shown in figure 2-5. Decide early in the approach whether it is necessary to go around, and start before you reach too low an altitude.

**AFTER LANDING.**

After the landing roll, clear the runway immediately and come to a complete stop. Before taxiing to the line:

1. Wing flap handle UP.
2. Trim tab control wheels neutral.
3. Propeller control full INCREASE.

**POSTFLIGHT ENGINE CHECK.**

After the last flight of the day, make the following checks:

**Note**

While performing checks requiring rpm reading, it may be necessary to tap the instrument panel to prevent tachometer sticking, especially in cold weather.

1. Check propeller control at full INCREASE.
2. Ignition switch check—at 700 rpm, turn ignition switch OFF momentarily. If engine does not cease firing completely, shut down engine and warn personnel to remain clear of the propeller until the ignition discrepancy has been corrected.

**CAUTION**

Perform this check as rapidly as possible to prevent severe backfire when ignition switch is returned to BOTH.

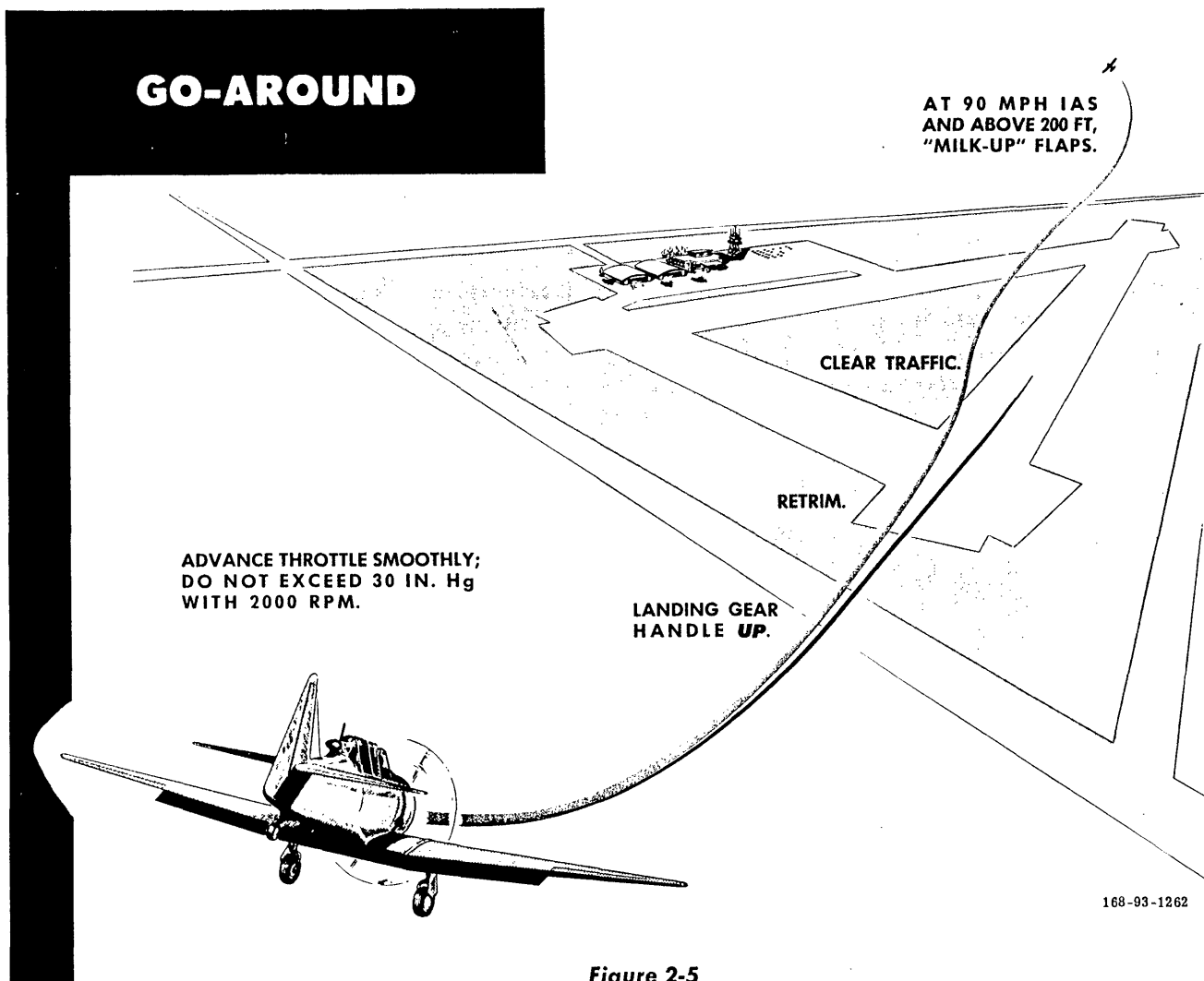

Figure 2-5

168-93-1262



3. Idle speed and mixture check—with throttle against idle stop, the engine should idle at 450 rpm. When engine speed is stabilized, move the mixture control slowly and smoothly toward IDLE CUT-OFF. Carefully observe the manifold pressure gage for any change during the leaning procedure. The manifold pressure should decrease slightly before it increases. An immediate increase indicates the mixture is set too lean. A momentary decrease in excess of  $\frac{1}{4}$  in. Hg indicates the mixture is set too rich. Return mixture control to RICH before engine cuts out.

4. Power check—adjust manifold pressure to field barometric pressure (as read on altimeter with elevation set to zero) and check for 2000 ( $\pm 50$ ) rpm.

#### Note

If less than the prescribed rpm is obtainable for given manifold pressure, the engine is not developing sufficient power and should be corrected before the next flight.

#### CAUTION

When running engine up to high power, be careful to have stick back and brakes applied.

5. Ignition system check—with throttle adjusted to 2000 rpm, position ignition switch to L and R, and in each position, check for maximum drop (not to exceed 100 rpm). Return ignition switch to BOTH between checks to allow speed to stabilize. If drop exceeds 100 rpm, return ignition switch to BOTH and run engine up to Take-off Power for a few seconds; then recheck ignition system at 2000 rpm. Return ignition switch to BOTH at completion of test.

6. Cruising fuel-air mixture check—with propeller control at full INCREASE and mixture control full RICH,

allow engine speed to stabilize at 1900 rpm. Move mixture control into the manual leaning range until an approximate 100 rpm drop is noted; then return to RICH. The engine speed should increase very slightly before it decreases. An immediate decrease indicates the mixture is set too lean. A momentary increase in excess of 25 rpm indicates the mixture is set too rich.

#### Note

Any discrepancies detected during the post-flight check should be entered on Form 1.

#### STOPPING ENGINE.

When a cold-weather start is anticipated, dilute oil as required by the lowest expected temperature. For oil dilution instructions, refer to Section IX.

1. Parking brakes set.
2. Open throttle to approximately 1450 rpm, place propeller control in full DECREASE, and allow engine to run for approximately one minute to allow the oil from the propeller to be scavenged back to the oil tank.
3. Stop engine by pulling mixture control full aft to the IDLE CUT-OFF position.
4. When propeller stops, close throttle completely and turn ignition switch to OFF.
5. Radio off.
6. All electrical switches off.
7. Battery switch OFF. Leave the generator switch ON.
8. Fuel selector OFF.

#### BEFORE LEAVING AIRPLANE.

1. Have the wheels chocked; then release brakes.
2. Lock the surface controls.
3. Complete Form 1.
4. Close canopy.





## Emergency Procedures

## SECTION III

### ENGINE FAILURE.

Engine failures fall into two main categories: those occurring instantly, and those with ample warning before failure. The instant failure is rare and usually occurs only if the ignition or fuel flow completely fails. Most engine failures are gradual and give the alert pilot ample indication that he may expect a failure. An extremely rough-running engine, loss of oil pressure, excessive cylinder head temperature under normal flight conditions, loss of manifold pressure, and fluctuating rpm are indications that a failure is imminent. When indications point to an engine failure, the pilot should make a landing immediately.

#### PROCEDURE ON ENCOUNTERING PARTIAL ENGINE FAILURE.

If engine failure appears imminent, and if altitude permits and it is reasonably safe to attempt to regain normal engine operation, proceed as follows:

1. Fuel selector to 70 GAL RIGHT or 70 GAL LEFT, depending on which tank contains more fuel.
2. If necessary, maintain adequate fuel pressure with hand fuel pump.
3. Mixture control full RICH.
4. Propeller control full INCREASE.

5. Check ignition switch at BOTH.

6. Carburetor air control HOT if icing conditions exist.

#### PROCEDURE ON ENCOUNTERING COMPLETE ENGINE FAILURE.

If the engine fails completely and if there is still sufficient altitude and it is reasonably safe to restart the engine, accomplish the foregoing procedure (partial engine failure) and then proceed as follows:

1. Move mixture control to IDLE CUT-OFF.
2. Advance throttle to full OPEN for a few seconds to clear engine.
3. Readjust throttle to ½-inch open.
4. Mixture control full RICH.
5. Prime engine if necessary.

If this procedure fails to restart the engine, shut down engine as follows:

1. Mixture control to IDLE CUT-OFF.
2. Throttle CLOSED.
3. Ignition switch OFF.
4. Fuel selector OFF.
5. Battery and generator switches OFF except when power is desired to operate lights or communication equipment.

**ENGINE FAILURE UNDER SPECIFIC CONDITIONS.**

**ENGINE FAILURE DURING TAKE-OFF.** If the engine fails during the take-off run, immediately close throttle and apply brakes. If remaining runway is insufficient for stopping and it becomes necessary, collapse the landing gear; then, if time permits, move the mixture control to **IDLE CUT-OFF**. Get clear of airplane immediately.

**ENGINE FAILURE AFTER TAKE-OFF.** If the engine fails immediately after take-off, proceed as follows:

1. Lower nose immediately to maintain airspeed above stall.
2. Landing gear handle **UP**. (Even if there is not sufficient time or hydraulic pressure to completely raise gear, it is better to have it unlocked so that it will collapse on landing. Judgment should be used on long runways where a gear-down landing could be accomplished.)
3. Fuel selector **OFF**.
4. Land straight ahead, changing direction only enough to miss obstacles. Don't try to turn back to the field. Making a crash landing straight ahead with airplane under control is much better than turning back and taking the chance of an uncontrolled roll into the ground. (See figure 3-1.)

**ENGINE FAILURE DURING FLIGHT.** If the engine fails during flight:

1. Lower nose as speed drops to maintain glide at approximately 100 mph.
2. If altitude permits, attempt to restart engine.
3. If it is impossible to restart engine, make a forced landing if possible; otherwise, bail out.

**MAXIMUM GLIDE.** Maximum glide distance can be obtained by maintaining a speed of 100 mph with gear

and flaps up and with propeller control at full **DECREASE** rpm to minimize drag. See figure 3-2 for optimum glide path.

Glide ratio and rate of descent at best glide speed under varying conditions are as shown in figure 3-6.

**DEAD-ENGINE LANDING.** See figure 3-3 for procedure to follow in case of a forced landing (power off) with gear up or down.

**PROPELLER FAILURE.**

A runaway condition of the propeller caused by excess power and decreased load on the engine can occur in a prolonged dive, and the engine may exceed the over-speed limit of 2800 rpm. At first evidence of a runaway or overspeeding propeller:

1. Retard throttle.
2. Adjust propeller control in an attempt to bring propeller within limits.
3. Pull airplane up in a climb to increase load on engine.

**FIRE.**

During starting, engine fire can occur in the induction system or in the exhaust system. However, pilot technique is the same in combating both types of fires. If a fire occurs in the engine accessory section, the engine should be stopped immediately.

**Note**

No fire extinguishing system is installed on this airplane.

**ENGINE FIRE DURING STARTING.**

1. Continue cranking in an attempt to clear or start engine, as fire may be drawn through engine or blown out the exhaust stacks and extinguished. Do not prime engine again.

**LAND STRAIGHT AHEAD**

Figure 3-1

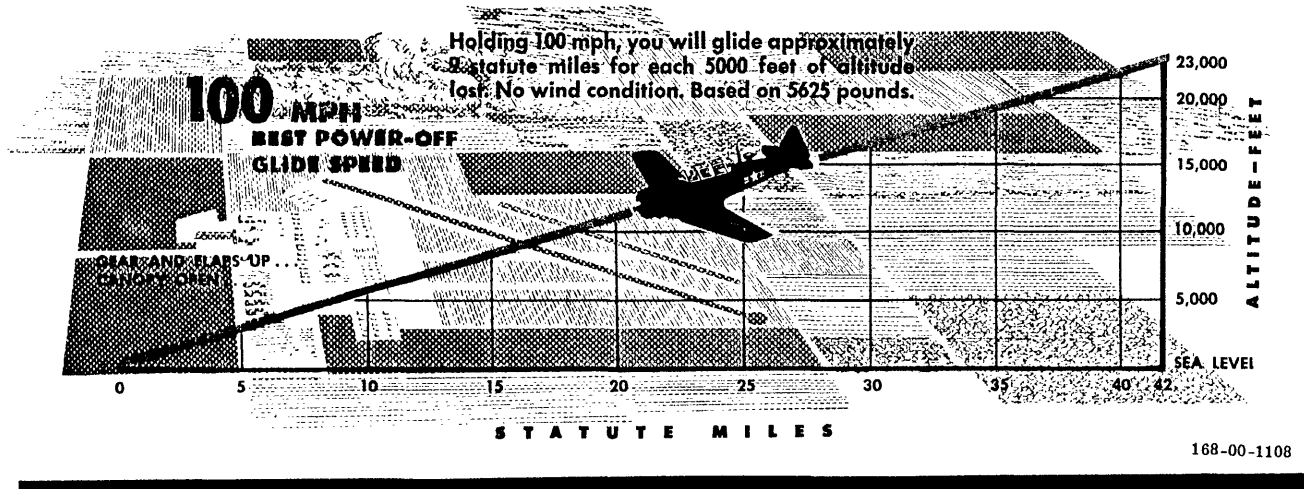
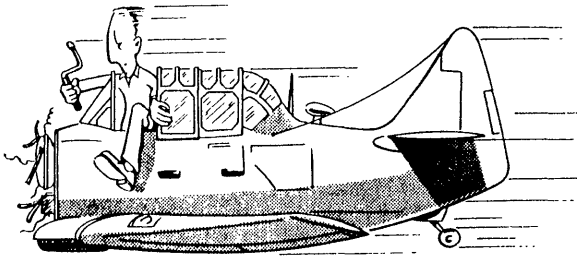

Figure 3-2. Maximum Glide

2. If engine does not start, continue cranking, move mixture control to IDLE CUT-OFF, and turn fuel selector, ignition, and generator switches OFF.



*Do not attempt restart if engine stopped because of obvious mechanical failure.*

3. If fire continues, stop cranking and turn battery switch OFF.

4. Get clear of airplane and signal ground crew to use portable fire extinguishing equipment.

#### ENGINE FIRE AFTER STARTING.

1. Keep the engine running, as the fire may be drawn through the engine and extinguished.

2. If fire continues to burn, shut down engine.

3. Get clear of the airplane and signal the ground crew to use the portable fire equipment.

4. Do not restart the engine until the cause of the fire has been determined.

#### ENGINE FIRE DURING FLIGHT.

Depending upon the severity of the fire, either bail out immediately or shut down the engine as follows in an attempt to extinguish the fire:

1. Mixture control to IDLE CUT-OFF.

2. Throttle CLOSED.

3. Ignition switch OFF.

4. Fuel selector OFF.

5. Battery and generator switches OFF, except when power is desired to operate lights or communication equipment.

#### FUSELAGE FIRE DURING FLIGHT.

1. Reduce airspeed immediately in preparation for bail-out (if it becomes necessary) and to lessen possibility of fire spreading.

2. If smoke or fumes enter cockpit, open canopy.

3. Generator and battery switches OFF.

4. If fire persists, shut down engine.

5. If possible, use hand fire extinguisher (figure 3-4), located on left side of rear cockpit.

### WARNING

Toxic fumes may be generated when fire extinguisher fluid (carbon tetrachloride) contacts hot metal.

6. If fire is not extinguished immediately, bail out.

#### WING FIRE DURING FLIGHT.

1. Turn off all wing light switches (navigation, passing, and landing) and pitot heater switch.

2. Attempt to extinguish fire by sideslipping airplane away from flame.

3. If fire is not extinguished immediately, bail out.

#### ELECTRICAL FIRE.

Circuit breakers isolate most electrical circuits and automatically interrupt power to prevent a fire when a "short" occurs. If necessary, however, turn generator and battery switches OFF to remove power from all electrical equipment and land as soon as possible. If electrical power is essential, as during instrument flight,

## FORCED LANDING DEAD ENGINE

Hold speed of 100mph IAS for maximum glide distance with gear and flaps up.

Mixture control to **IDLE CUT-OFF**.

Throttle **CLOSED**.

Ignition switch **OFF**.

Fuel selector **OFF**.

Battery-disconnect and generator switches **OFF**.

### NOTE

Do not turn battery-disconnect switch **OFF** until just before touchdown if landing lights or radio is to be used during approach.

Propeller control full **DECREASE**.

Canopy locked **OPEN**.

Leave landing gear handle **UP** unless **certain** that field is suitable for a gear-down landing. Remember, the airplane will glide farther with gear up. If landing gear is lowered, yaw airplane to lock gear down.

Parachute unbuckled.

Shoulder harness locked. Remember, some switches are not readily accessible when harness is locked.

To steepen glide, lower flaps as required and reduce speed to 75 mph IAS.

### WARNING

Do not slip airplane at speeds below 90 mph IAS.

Land as nearly upwind as possible. Touch down approaching stall speed with tail low, whether gear is up or down.

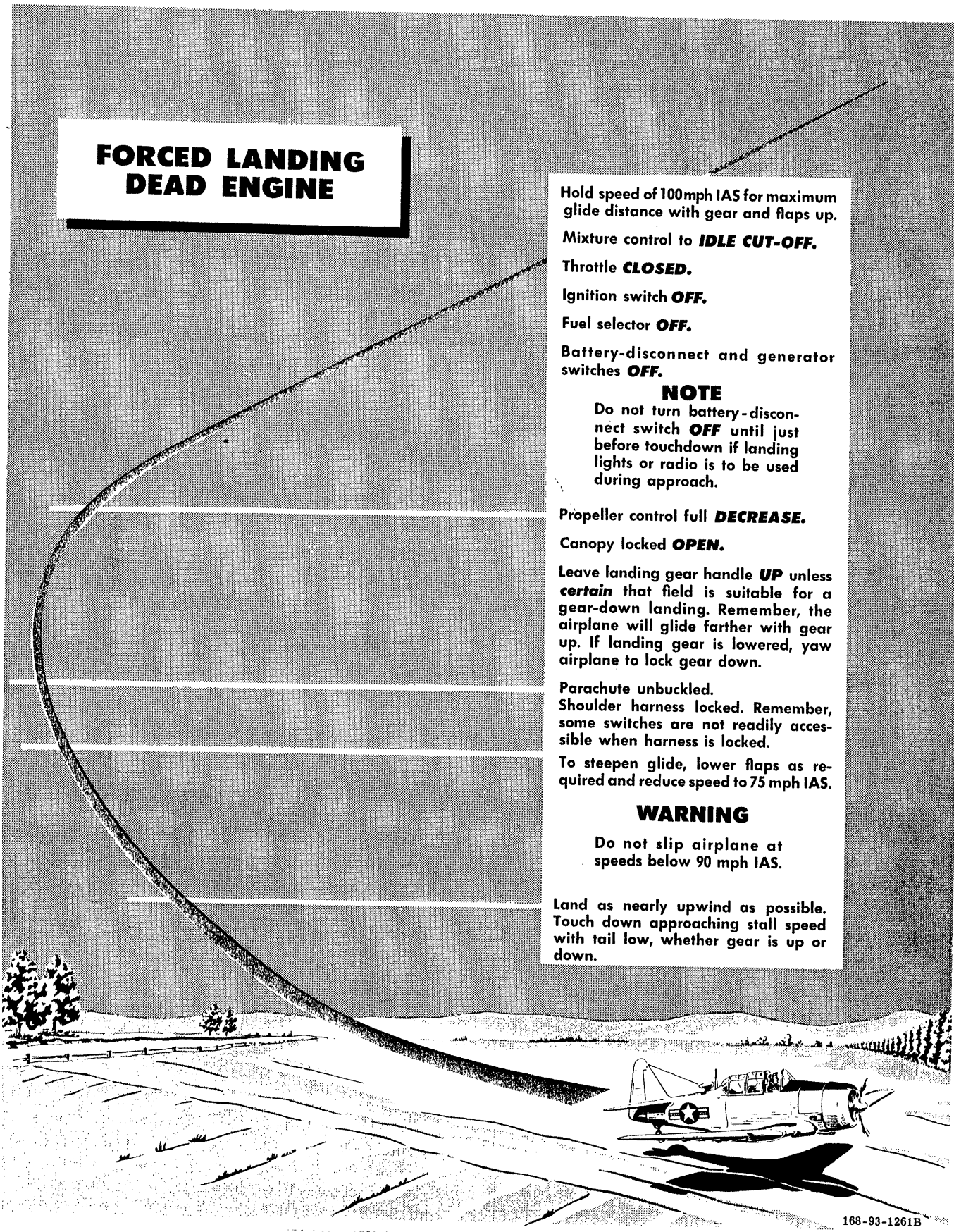

168-93-1261B

Figure 3-3



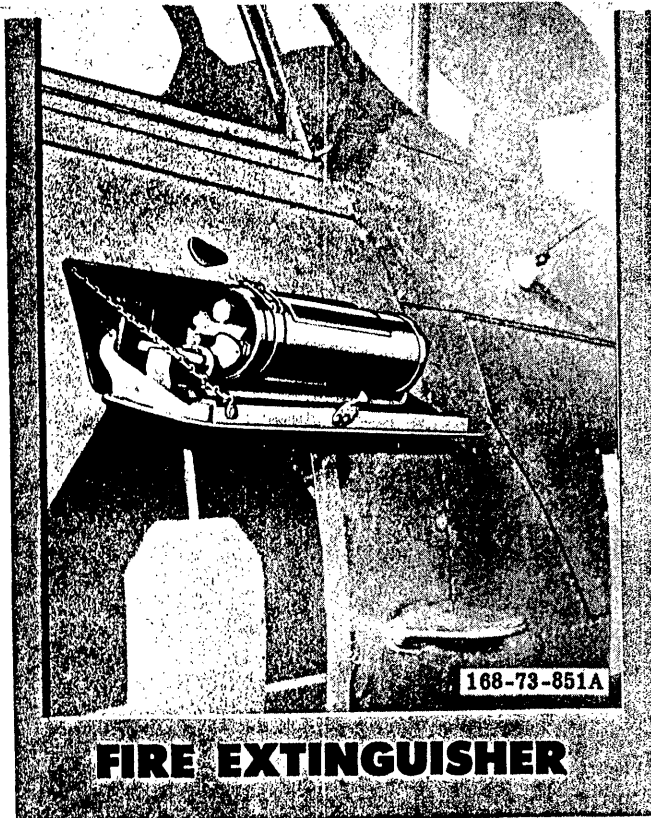

Figure 3-4

an attempt to identify and isolate the shorted circuit may be feasible. This can be accomplished as follows:

1. With generator and battery switches OFF, turn off all remaining switches (except ignition, of course).
2. Turn generator switch ON. If generator circuit is shorted, return switch to OFF and place battery switch ON instead.
3. Individually turn each circuit on again, allowing a short period of time before proceeding to the next, until the shorted circuit is identified.

#### SMOKE ELIMINATION.

If smoke or fumes enter the cockpit, proceed as follows:

1. Reduce airspeed immediately in preparation for bail-out (if it becomes necessary) and to minimize spreading of fire.
2. Open cold-air outlets.
3. Open canopy.

#### LANDING EMERGENCIES.

##### GEAR RETRACTED.

If the gear fails to extend, a wheels-up landing can be made on either hard or soft ground as follows:

1. Shoulder harness locked.

Revised 30 January 1953

#### CAUTION

Remember some switches are not readily accessible when the harness is locked.

2. Establish a normal flaps-down approach.
3. Flare out as in a normal landing (with tail low). This will enable tail wheel to absorb the initial shock.
4. Mixture control to IDLE CUT-OFF.
5. Get clear of airplane immediately.

#### ONE WHEEL RETRACTED (HARD GROUND).

Ordinarily a wheels-up landing is preferable to a landing with only one wheel extended. However, if one wheel is extended and cannot be retracted, proceed as follows:

1. Shoulder harness locked.

#### CAUTION

Remember some switches are not readily accessible when the harness is locked.

2. Make normal flaps-down approach with wing low on the extended-gear side.
3. Touch down on main wheel and tail wheel simultaneously. Use ailerons to hold up wing with retracted gear.
4. Shut down engine.
5. Maintain controlled ground roll by use of steerable tail wheel and brake.
6. When wing tip strikes the ground, apply maximum brake pressure possible without raising the tail.

#### Note

(Deleted.)

#### FLAT TIRE.

If a tire is flat at the time of landing or a blowout occurs during the ground roll, proceed as follows:

1. Hold stick full back to keep tail down, and apply full aileron opposite the flat tire.
2. Apply brake hard to wheel opposite the flat tire, and use steerable tail wheel to try to maintain a controlled landing roll.
3. Shut down engine.

#### EMERGENCY ENTRANCE.

The canopy lever on the exterior left side of each canopy is used for entrance to either cockpit in an emergency.

**EMERGENCY ESCAPE ON THE GROUND.**

A removable canopy panel is located on each side of each cockpit. If the canopy cannot be opened, these panels can be pushed outward for emergency escape. (See figure 3-5.)

**DITCHING.**

The airplane should be ditched only as a last resort. Since all emergency equipment is carried by the pilots, there is no advantage in riding the airplane down. However, if for some reason bail-out is impossible and ditching is unavoidable, proceed as follows:

**WARNING**

Be sure to ditch while sufficient fuel is available.

1. Follow radio distress procedure.
2. Turn battery switch OFF.
3. See that no personal equipment will foul when you leave the airplane.
4. Unbuckle parachute and release the life raft from the parachute harness. Tighten and lock safety belt and shoulder harness, as there is a violent deceleration of the airplane upon final impact.

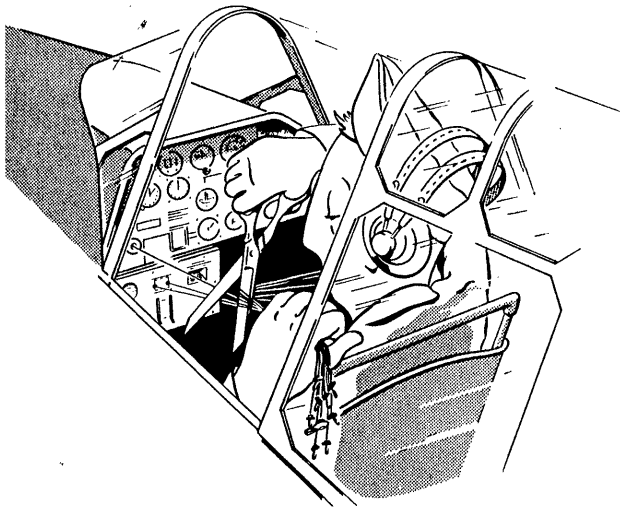

*Before a forced landing, all switches not readily accessible with the harness locked should be "cut" before the harness lock handle is moved forward to the locked position.*

5. Check landing gear handle UP.
6. Canopy full open and locked.
7. Lower wing flaps 20 degrees if sufficient hydraulic pressure is available.

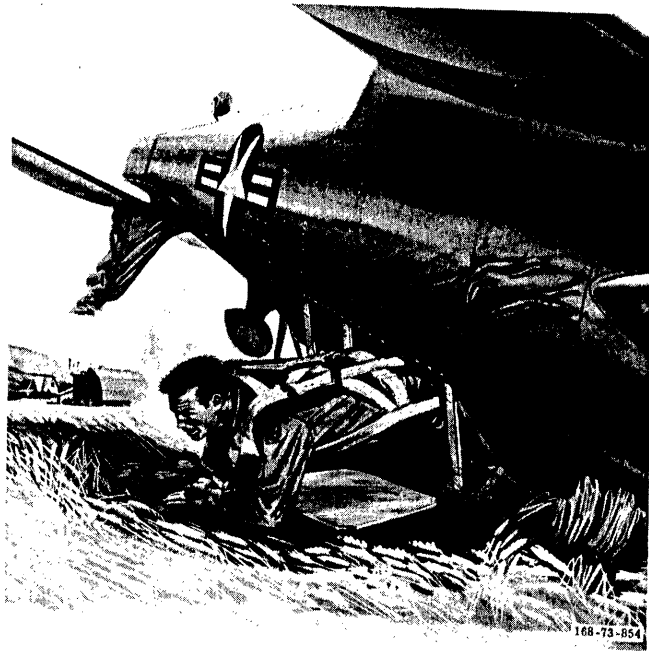

**Figure 3-5. Emergency Escape on the Ground**

8. Make normal approach with power if possible, and flare out to a normal landing attitude. Touch down approaching stalling speed with tail low. Unless the wind is high or the sea is rough, plan the approach heading parallel to any uniform swell pattern and try to touch down along a wave crest or just after a crest has passed. If the wind is as high as 40 mph or the surface is irregular, the best procedure is to approach into the wind and touch down on the falling side of the wave.

9. Just before impact, turn ignition switch OFF.
10. The back cushion of both cockpit seats is filled with kapok and may be used as a life preserver.
11. When leaving airplane, be sure to carry life raft with you.

**BAIL-OUT.**

In the event the decision has been made to abandon the airplane in flight, the following steps should be taken:

1. Reduce airplane speed as much as possible; trim airplane slightly nose-down and head for an uninhabited area.
2. Warn the other pilot to bail out and receive his acknowledgment.
3. See that no personal equipment will foul when you bail out.
4. Raise seat to top position.
5. Canopy full open and locked.

**Note**

If the canopy cannot be opened, push the canopy side panel clear of the airplane.

6. From either cockpit, dive toward trailing edge of wing. (See figure 3-7)



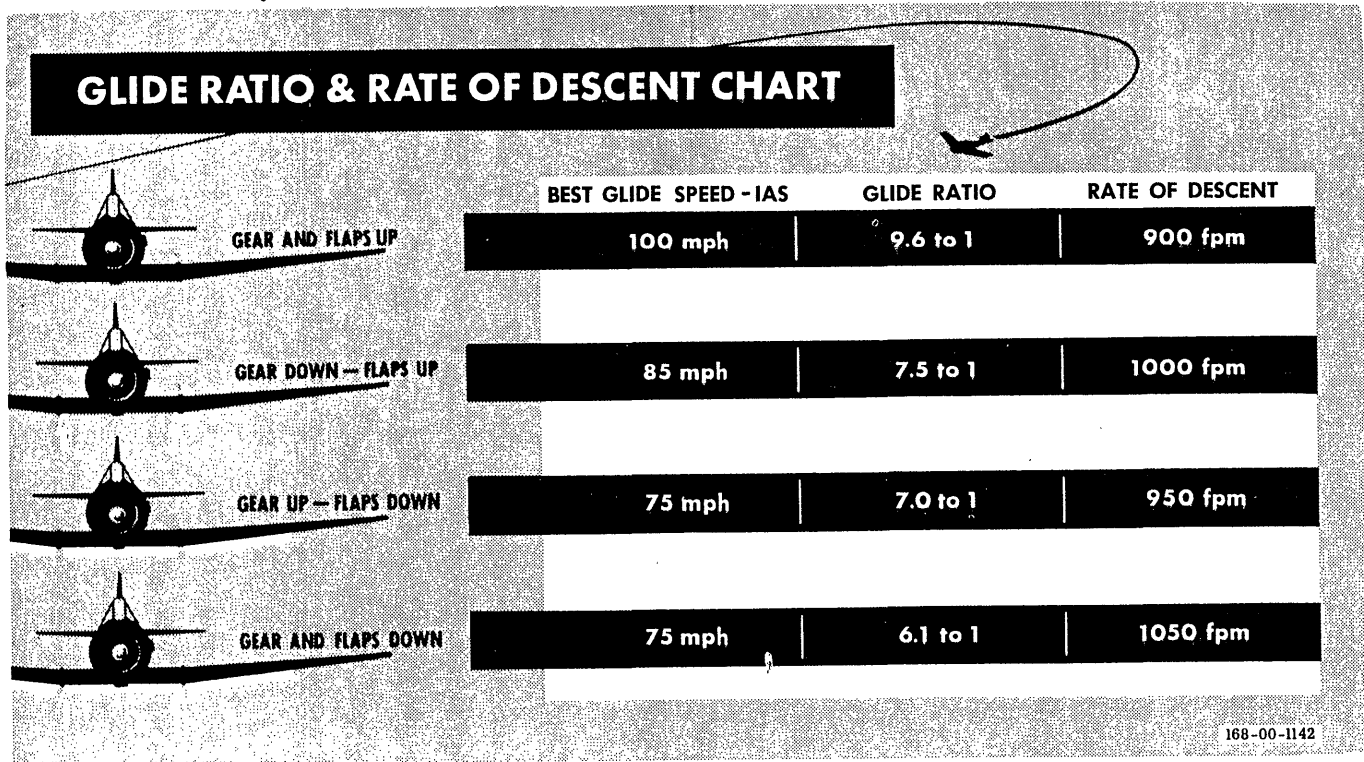

Figure 3-6

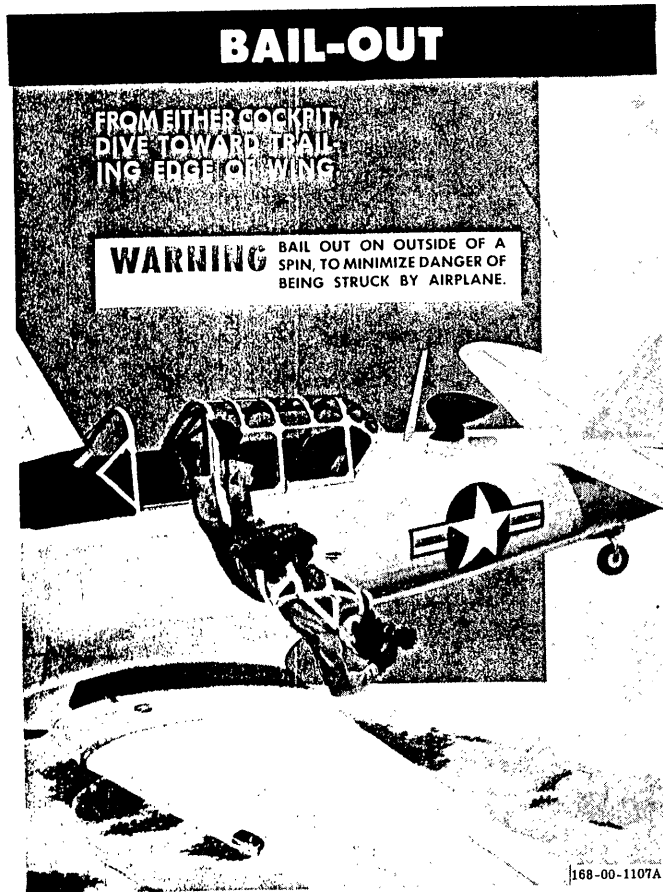

Figure 3-7

### FUEL SYSTEM EMERGENCY OPERATION.

If the engine-driven fuel pump fails, fuel can be supplied to the engine by operation of the hand fuel pump on the left side of each cockpit. If gasoline fumes can be detected by the pilot, a landing should be made as soon as possible and the source of fumes investigated.

### ELECTRICAL POWER SYSTEM EMERGENCY OPERATION.

If the ammeter shows zero current during flight, it may indicate failure of the generator system. In such case, the battery will supply the electrical load for a short time only. Turn the generator switch OFF, and conserve the battery by using electrical equipment sparingly. If a complete electrical failure occurs or if it becomes necessary to turn off both the generator and battery switches, landing should be made as soon as possible. See figure 1-10 for electrically operated equipment.

### LANDING GEAR SYSTEM EMERGENCY OPERATION.

#### LANDING GEAR EMERGENCY LOWERING.

The procedure for lowering the landing gear in case of complete hydraulic failure is given in figure 3-8.

#### LANDING GEAR EMERGENCY DOWNLOCK.\*

If the landing gear fails to automatically lock in the

\* Airplanes AF49-3157 and subsequent

## IN CASE OF COMPLETE HYDRAULIC FAILURE, THE LANDING GEAR CAN BE LOWERED AS FOLLOWS:

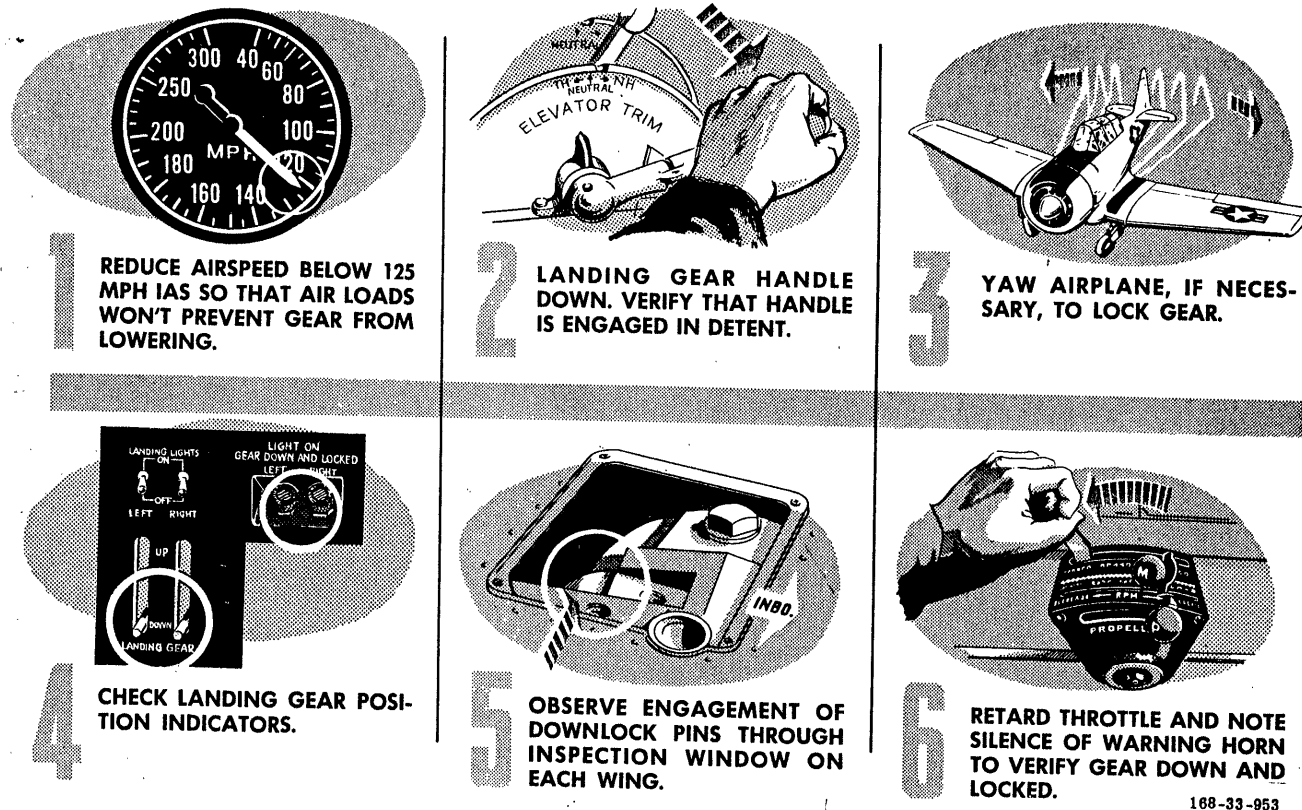

## LANDING GEAR EMERGENCY LOWERING

Figure 3-8

down position, move the emergency landing gear downlock handle back to the extreme rearward position. This manually forces the downlock pins in place to lock the gear down. However, the handle must never be pulled full back *before* the gear is completely down; if the handle is pulled back when the gear is partially down, the downlock pins may prevent the gear from extending fully.

### Note

The landing gear downlock pins can be visually checked for locked position through a window in the wing above the landing gear strut.

### HAND-CRANKING ENGINE.

If electrical power is not available, the starter can be energized manually by a hand crank as follows:

1. Move the brush spring release handle on the back of the starter to OFF (clockwise). The handle can be reached through an access door on the upper left side of the engine compartment cowling.
2. Insert hand crank into opening provided forward of the access door and rotate approximately 80 rpm.
3. When this speed has been attained, remove hand crank and pull manual engaging ring located above crank opening.
4. After engine starts, release engaging ring, return brush spring release handle to ON and safety with wire; then stow crank in baggage compartment.

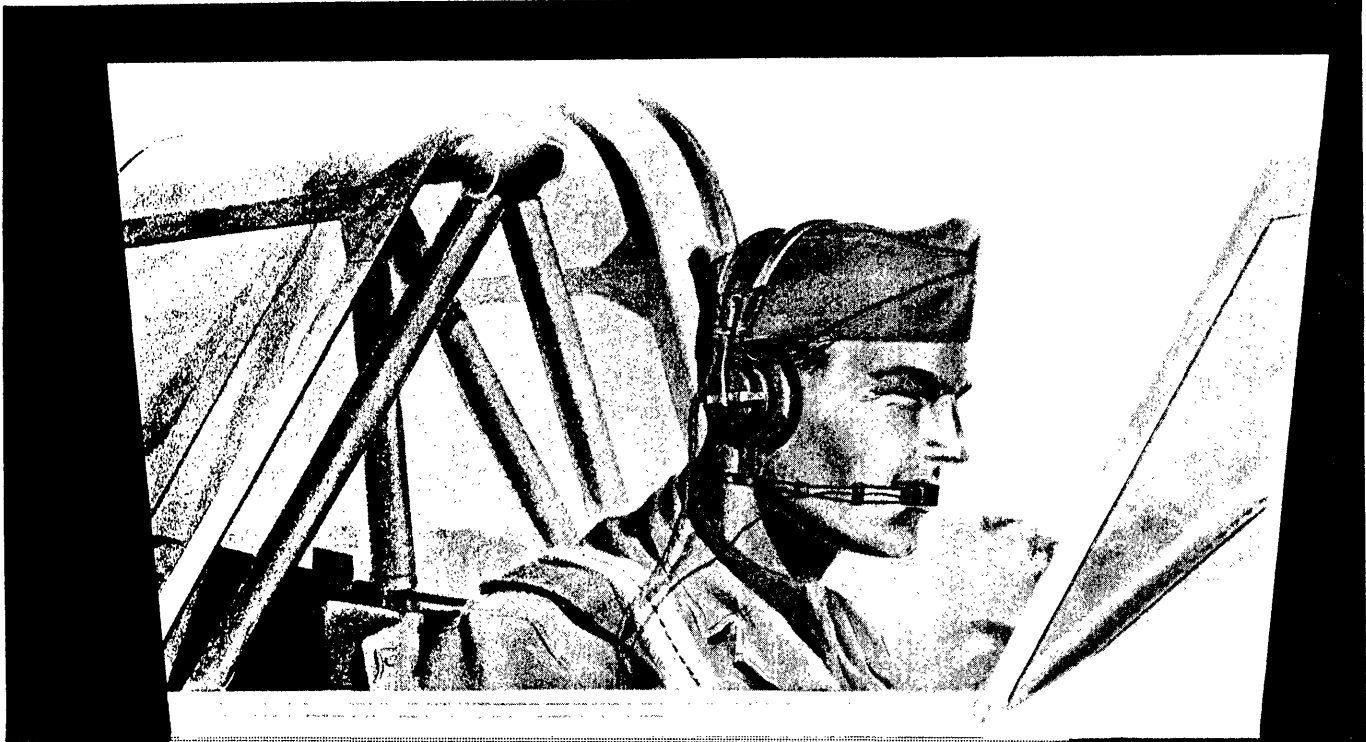

## DESCRIPTION AND OPERATION OF *Auxiliary Equipment*

### SECTION IV

#### HEATING SYSTEM.

Ram air from a duct opening on the top front of the engine is heated in a shroud around the exhaust manifold and is then introduced into the front cockpit. The cockpit hot-air temperature control valve (4, figure 1-20) is located inboard of the right rudder pedal. A butterfly valve in the outlet can be rotated by the pilot's foot to regulate the volume of hot air entering the cockpit.

#### VENTILATING SYSTEM.

Cold air for ventilating is obtained from an opening in the leading edge of the left wing center section and is discharged in the front cockpit from a cold-air temperature control valve (6, figure 1-20), located inboard of the left rudder pedal. The outlet, which incorporates a butterfly valve, can be adjusted by the pilot's foot to control the volume of air entering the cockpit. A ventilator on the left side of the rear cockpit can be manually opened by a handle (14, figure 1-23) to provide fresh air for the rear cockpit. Additional ventilation may be obtained by opening the sliding sections of the canopy to any one of the intermediate positions.

#### PITOT HEATER.

A heater in the pitot head is controlled by the pitot heater switch (7, figure 1-18), located on the right-hand console in the front cockpit only.

#### CAUTION

To prevent burning out heater elements, the pitot heater switch should be OFF when the airplane is on the ground.

#### COMMUNICATIONS AND ASSOCIATED ELECTRONIC EQUIPMENT.

##### COMMUNICATIONS MASTER CONTROL.

INTERPHONE CONTROL PANEL.\* An interphone control panel for partial control of the communications equipment is located on the right console in each

\* Airplanes AF51-14314 thru -15137, and -17354 and subsequent

AN/ARC-3

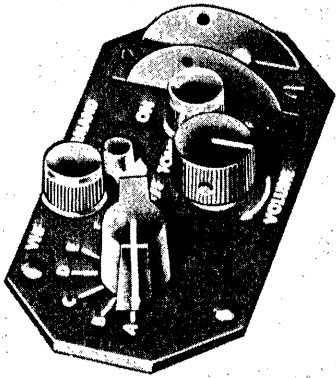

RC-193A  
AN/ARN-12

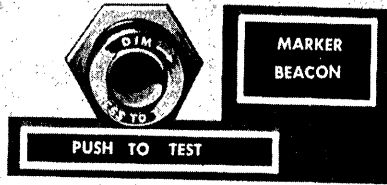

AN/ARN-6

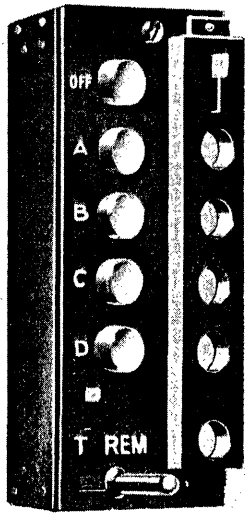
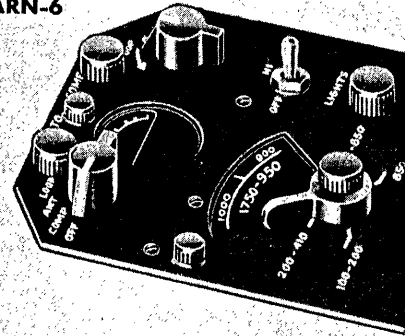

SCR-522A

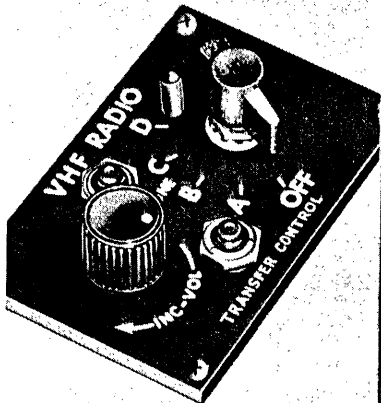

SCR-522A

### COMMUNICATION AND ASSOCIATED

| TYPE                | DESIGNATION        | LOCATION OF CONTROLS   |
|---------------------|--------------------|--|
| VHF COMMAND         | SCR-522A *         | Right console, each cockpit; microphone button on each throttle.                   |
|                     | AN/ARC-3 † ‡       |  |
| RADIO COMPASS       | AN/ARN-7 §         | Control panel below each instrument panel; indicator on each instrument panel.     |
|                     | AN/ARN-6 ¶         | Control panel on right console, both cockpits; indicator on each instrument panel. |
| MARKER BEACON       | RC-193A §          | Indicator light on each instrument panel.  |
|                     | AN/ARN-12 ¶        | Right console, each cockpit; indicator light on each instrument panel.             |
| INTERPHONE          | Part of SCR-522A § | Right console, rear cockpit; switch above each throttle quadrant.                  |
|                     | USAF combat ¶      | Right console, each cockpit; switch above each throttle quadrant.                  |
| GLIDE PATH RECEIVER | AN/ARN-5A § **     | Right console and instrument panel, each cockpit.                                  |
| LOCALIZER RECEIVER  | RC-103A § **       | Right console and instrument panel, each cockpit.                                  |
| EMERGENCY KEYS      | AN/ARA-26 ¶ **     | * *  |

\* AF49-2897 through -3537, AF50-1277 through -1326, AF51-14359 through -14683, and -15138 and subsequent

† AF51-14314 through -14358, -14684 through -15137, and -17354 and subsequent

‡ AF51-14359 through -14683 (provisions only)

Figure 4-1 (Sheet 1 of 2)

AN/ARN-7

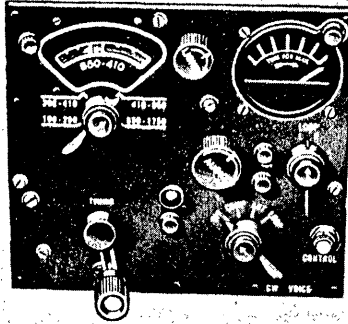
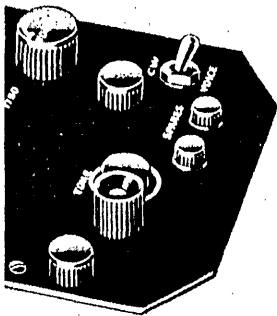

PART OF SCR-522A

**ELECTRONIC EQUIPMENT**

| USE  | HORIZONTAL RANGE  |
|--|---|
| Two-way communication  | 30 miles at 1000 feet,<br>135 miles at 10,000 feet                        |
| Reception of voice, code communication; position finding, homing | 50 to 100 miles for range signals, 100 to 250 miles for broadcast signals |
| Reception of location marker beacon signals (fan marker)         |   |
| Intercockpit communication                                       |   |
| Instrument landing system  | 20 miles  |
| Instrument landing system  | 20 miles  |
| Distress call  | 30 miles at 1000 feet,<br>135 miles at 10,000 feet                        |

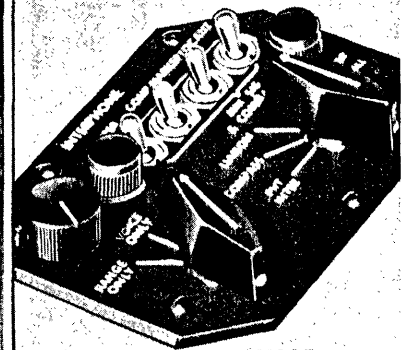

USAF COMBAT

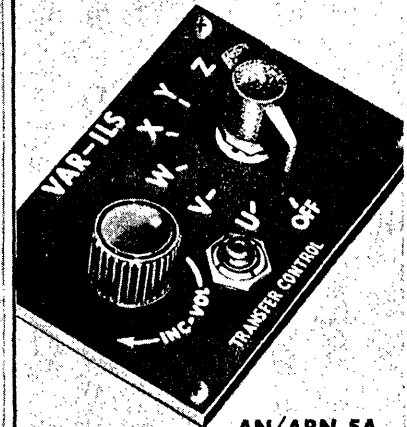

AN/ARN-5A RC-103A

§ AF49-2897 through -3537, AF50-1277 through -1326, AF51-15138 through -15237, and -16071 and subsequent

¶ AF51-14314 through -15137, and -17354 and subsequent

\*\* Provisions only

168-71-816A

Figure 4-1 (Sheet 2 of 2)

cockpit. The following table gives the location and positions of the incorporated controls and indicates the airplanes on which the controls are disconnected.

| PANEL CONTROLS            | LOCATION                       |                               | MARKED POSITION  | CONTROL DISCONNECTED       |
|---------------------------|--------------------------------|-------------------------------|--|----------------------------|
|                           | FRONT COCKPIT<br>(Figure 1-19) | REAR COCKPIT<br>(Figure 1-26) |  |                            |
| Master selector switch    | 12                             | 6                             | PVT INTER<br>COMPASS<br>LIAISON<br>MIX SIG & COMMAND<br>INTER<br>CALL<br>INTER | *<br>*<br>*<br>*<br>†<br>† |
| Interphone switch         | 25                             | 19                            |  |                            |
| Radio compass switch      | 24                             | 18                            | COMP   |                            |
| Marker beacon switch      | 11                             | 5                             | MARKER   | †                          |
| Localizer switch          | 10                             | 4                             | LOCALIZER  | *                          |
| Master volume control     | 26                             | 20                            |  |                            |
| Radio range filter switch | 23                             | 17                            | RANGE ONLY<br>VOICE ONLY<br>BOTH   |                            |

\* Airplanes AF51-14314 thru -15137, and -17354 and subsequent.  
† Airplanes AF51-14359 thru -14683

The vhf command set is selected by moving the master selector switch to MIX SIG & COMMAND. The master selector switch is spring-loaded from CALL to INTER. The CALL position is used to interrupt radio transmission or reception to enable immediate interphone communication. The interphone, radio compass, marker beacon, and localizer switches may be selected individually or collectively when the master selector switch is at MIX SIG & COMMAND. The master volume control knob increases volume when rotated clockwise. Placing the radio range filter switch in the RANGE ONLY position subdues voice reception to bring out range reception. Moving the filter switch to the VOICE ONLY position causes radio range signals to be subdued to bring out voice reception. In the BOTH position, voice and range signals are received in equal volume.

#### AN/ARC-3 VHF COMMAND RADIO CONTROLS AND INDICATOR.

**VHF COMMAND RADIO CONTROL PANEL.\*** The command radio control panel, located on the right console in each cockpit, incorporates a vhf power switch (15, figure 1-19; 10, figure 1-26), a vhf audio control knob (18, figure 1-19; 11, figure 1-26), and a vhf channel selector switch (19, figure 1-19; 15, figure 1-26). The command set is turned on when the power switch is placed in the ON position.

**MICROPHONE CONTROL BUTTON.** The microphone control button (14, figure 1-17; 13, figure 1-23), located on the throttle knob in each cockpit, permits voice transmission when manually depressed. To permit reception, the button must be released.

**VHF CONTROL TRANSFER SWITCH.\*** A control transfer switch (16, figure 1-19; 12, figure 1-26), mounted on the transfer control panel of the right console in each cockpit, is provided to enable either pilot to control channel selection of the command radio.

**VHF CONTROL INDICATOR LIGHT.\*** A control indicator light (17, figure 1-19; 14, figure 1-26) is located on the transfer control panel of the right console in each cockpit. The light illuminates in the cockpit from which the command set can be controlled as determined by the vhf control transfer switch.

#### OPERATION OF AN/ARC-3 VHF COMMAND RADIO.

1. Position vhf control transfer switch so that indicator light illuminates.
2. Turn master selector switch to MIX SIG & COMMAND.
3. Place vhf power switch to ON.
4. Rotate channel selector switch to desired frequency channel.
5. Allow 30 to 40 seconds for set to warm up. Near end of warm-up period, an audio tone will be heard in the headset. When the tone stops, the set is ready for operation and may be tuned.
6. Adjust vhf audio control knob for desired output. Rotate control clockwise to increase volume.
7. Depress microphone control button to transmit; release button to receive. Reception will be cut off at both crew stations whenever either button is depressed.

\* Airplanes AF51-14314 thru -14358, -14684 thru -15137, and -17354 and subsequent

**Note**

Do not turn vhf command radio off immediately after selecting a desired channel. If the automatic selector has not had sufficient time to complete its change cycle, the set will be inoperative when it is again turned on. Should this occur, turn the set on and select any channel other than that presently selected. Then, after cycle is completed, select the desired channel, and the set will resume normal operation.

**SCR-522A VHF COMMAND RADIO CONTROLS.\***

**VHF COMMAND RADIO CONTROL PANEL.\*** A command radio control panel (figure 4-2) is located just forward of the right console in each cockpit. The panel incorporates channel selector buttons and channel selector lights, illumination of which can be controlled by a dimming lever. In addition, the panel incorporates an "OFF" push button and a receiving indicator light that illuminates whenever the set is in the receive condition. The function switch is disconnected; consequently, the adjacent function switch locking lever is not utilized.

**OPERATION OF SCR-522A VHF COMMAND RADIO.\***

1. Position vhf control transfer switch so that indicator light illuminates.
2. Turn master selector switch to MIX SIG & COMMAND.
3. Depress desired channel selector button and note illumination of corresponding channel selector light.
4. Allow 30 to 40 seconds for set to warm up. Near end of warm-up period, an audio tone will be heard in the headset. When the tone stops, the set is ready for operation and may be tuned.
5. Adjust master volume control knob for desired output. Rotate control clockwise to increase volume.
6. Depress microphone control button to transmit; release button to receive. Reception will be cut off at both crew stations whenever either button is depressed.

**SCR-522A VHF COMMAND RADIO CONTROLS.†**

**VHF COMMAND RADIO CONTROL PANEL.‡** The command radio control panel, located on the right console in each cockpit, incorporates a vhf radio volume control knob (13, figure 1-18; 12, figure 1-24) and a vhf channel selector switch (12, figure 1-18; 3, figure 1-24). In addition to increasing volume, the control knob turns the set on when turned clockwise from its OFF position.

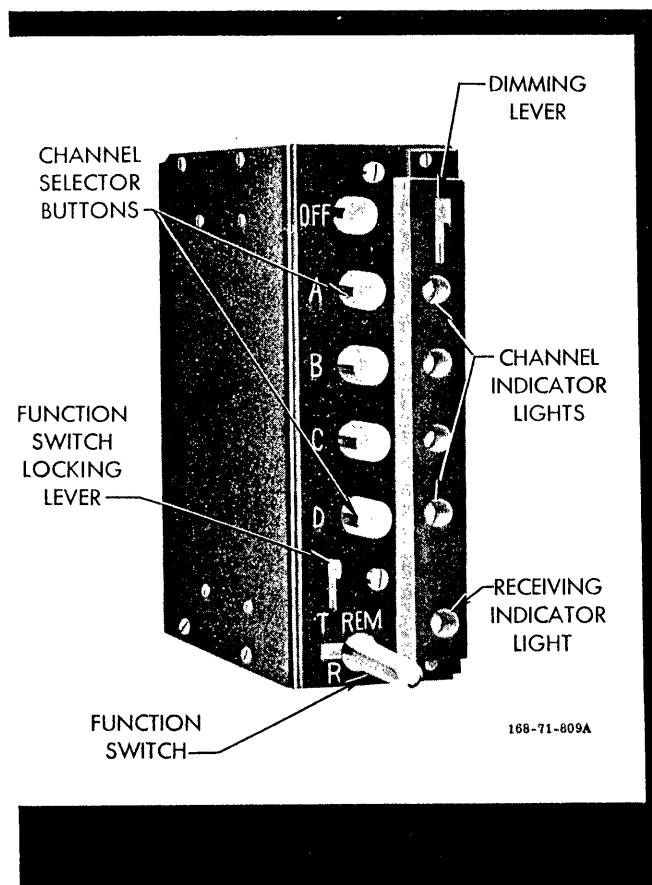

**Figure 4-2. SCR-522A Radio Control Panel—  
Airplanes AF51-14359 Through -14683**

**VHF CONTROL TRANSFER SWITCH.‡** The control transfer switch (8, figure 1-24), mounted on the right console in the rear cockpit, is provided to enable the rear cockpit occupant to control channel selection of the command radio. During solo flight the switch must be in the FRONT position to permit channel selection from the front cockpit. This switch has no effect on reception of radio signals.

**VHF COMMAND RADIO CONTROL PANEL.§** The command radio control panel, located on the right console in each cockpit, incorporates a vhf radio volume control knob (13, figure 1-18; 14, figure 1-25) and a vhf channel selector switch (12, figure 1-18; 3, figure 1-25). In addition to selecting desired channels, the channel selector switch turns the set on when moved clockwise from its OFF position.

**VHF CONTROL TRANSFER PUSH BUTTON.§** A control transfer push button (14, figure 1-18; 13, figure 1-25), mounted on the command radio control panel

\* Airplanes AF51-14359 thru -14683

† Airplanes AF49-2897 thru -3537, AF50-1277 thru -1326, AF51-15138 thru -15237 and -16071 thru -16077

‡ Airplanes AF49-2897 thru -2981

§ Airplanes AF49-2982 thru -3537, AF50-1277 thru -1326, AF51-15138 thru -15237, and -16071 thru -16077



in each cockpit, is provided to enable either pilot to control channel selection of the command radio. This switch has no effect on reception of radio signals.

#### OPERATION OF SCR-522A VHF COMMAND RADIO.\*

1. On early airplanes,† place vhf control transfer switch to desired FRONT or REAR position. On some airplanes,‡ depress vhf transfer control push button for desired control.

2. On early airplanes,† turn radio volume control knob clockwise to turn set on.

3. Rotate channel selector switch clockwise to desired frequency channel. On some airplanes,‡ this action also turns the set on.

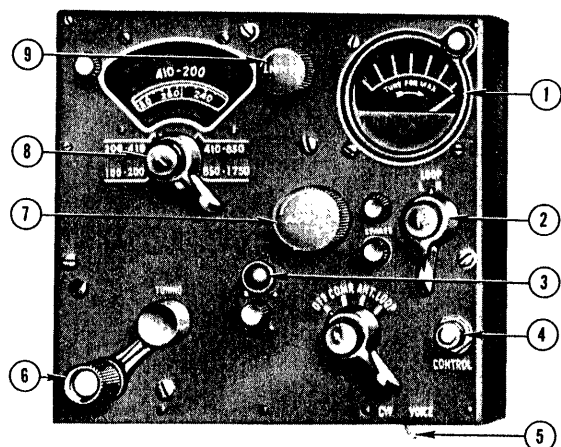

1. TUNING METER
2. LOOP ADJUSTMENT SWITCH
3. CONTROL INDICATOR LIGHT
4. CONTROL BUTTON
5. CW SELECTOR SWITCH
6. TUNING CRANK
7. AUDIO CONTROL KNOB
8. FREQUENCY BAND SELECTOR
9. LIGHT CONTROL KNOB

168-71-732C

Airplanes AF49-2897 Through -3537, AF50-1277 Through -1326, AF51-15138 Through -15237, and -16071 Through -16077

## RADIO COMPASS CONTROL PANEL

Figure 4-3

4. Allow 30 to 40 seconds for set to warm up. Near end of warm-up period, an audio tone will be heard in the headset. When the tone stops, the set is ready for operation and may be tuned.

5. Adjust radio volume control knob for desired output. Rotate control clockwise to increase volume.

6. Depress microphone control button to transmit; release button to receive. Reception will be cut off at both crew stations whenever either button is depressed.

#### D/F TONE PUSH BUTTON.§

A d/f tone push button (11, figure 1-18; 15, figure 1-25; 20, figure 1-19; and 9, figure 1-26), mounted on the command radio control panel in each cockpit, is manually depressed to transmit a tone modulated signal. This enables a d/f equipped ground station to obtain a tone signal and determine the airplane heading.

#### RADIO RANGE FILTER SWITCH.‡

The radio range filter switch (20, figure 1-18; 6, figure 1-25) is mounted on a panel in each cockpit just aft of the right console. Placing the switch in the RANGE position subdues voice reception to bring out range reception. Moving the switch to the VOICE position causes radio range signals to be subdued to bring out voice reception. In the BOTH position, voice and range signals are received in equal volume.

#### OPERATION OF AN/ARN-7 RADIO COMPASS.

1. Place cw selector switch at VOICE. For reception of continuous wave transmission, place cw selector switch to CW position.

2. Turn radio compass power switch to ANT.

3. Depress radio compass control button. When control is complete, the indicator on the tuning meter fluctuates and the green control indicator light illuminates.

4. If radio range reception is desired (on some airplanes), turn radio range filter switch to BOTH until signal is properly tuned (step 6); then place filter switch at RANGE or VOICE as desired.

5. Rotate radio compass frequency band selector as desired.

6. Rotate tuning crank to tune in desired frequency as indicated by maximum deflection of the indicator on the tuning meter. Proper station is identified by published call sign.

7. Adjust radio compass audio control knob for desired output.

8. To actuate needle on radio compass indicator, place radio compass power switch at COMP.

\* Airplanes AF49-2897 thru -3537, AF50-1277 thru -1326, AF51-15138 thru -15237, and -16071 thru -16077

† Airplanes AF49-2897 thru -2981

‡ Airplanes AF49-2982 thru -3537, AF50-1277 thru -1326, AF51-15138 thru -15237, and -16071 thru -16077

§ Airplanes AF49-2982 thru -3537, AF50-1277 thru -1326, AF51-14314 thru -14358, and -14459 and subsequent

9. When using the radio compass for aural-null procedures, the set should be tuned for maximum readability rather than maximum deflection of the tuning meter. For maximum reception or aural-null orientation and homing, the loop antenna can be rotated by using the loop adjustment switch on the radio compass control panel. Pushing the switch in against a spring load and moving it to L or R causes the loop antenna to revolve rapidly for large adjustments. In the normal position to which the switch is spring-loaded, its movement causes the loop to revolve slowly for fine adjustments. The radio compass power switch should be at LOOP for adjustment of the loop antenna.

#### OPERATION OF AN/ARN-6 RADIO COMPASS.

1. Place cw selector switch at VOICE. For reception of continuous wave transmission place cw selector switch to CW position.

2. With master selector switch on the interphone control panel at MIX SIG & COMMAND, turn on radio compass switch at same panel.

3. Turn radio compass power switch to CONT. When control is complete, the indicator on the tuning meter fluctuates.

4. If radio range reception is desired, turn radio range filter switch to BOTH until signal is properly tuned (step 7); then place filter switch at RANGE or VOICE as desired.

5. Turn radio compass power switch to ANT.

6. Rotate radio compass frequency band selector as desired.

7. Rotate tuning crank to tune in desired frequency as indicated by maximum deflection of the indicator on the tuning meter. Proper station is identified by published call sign.

8. Adjust radio compass audio control knob for desired output.

9. To actuate needle on radio compass indicator, place radio compass power switch at COMP.

10. When using the radio compass for aural-null procedures, the set should be tuned for maximum readability rather than maximum deflection of the tuning meter. For maximum reception or aural-null orientation and homing, the loop antenna can be rotated by using the loop adjustment switch on the radio compass control panel. Revolution of the loop antenna is relatively slow or relatively fast depending on how far the switch is moved toward the L or R. The radio compass power switch should be at LOOP for adjustment of the loop antenna.

#### OPERATION OF RC-193A MARKER BEACON.

The marker beacon operates automatically when the battery-disconnect switch is turned ON. The marker beacon signal light on each instrument panel illuminates when the airplane passes over a marker station.

#### OPERATION OF AN/ARN-12 MARKER BEACON.

The marker beacon operates automatically when the battery-disconnect switch is turned ON. The marker beacon signal light on each instrument panel illuminates when the airplane passes over a marker station. In addition to the light indication, audio signals are received on some airplanes.\* For reception of audio signals, the marker beacon switch on the interphone control panel is placed in the MARKER position and the master selector switch on the same panel is placed in the MIX SIG & COMMAND position.

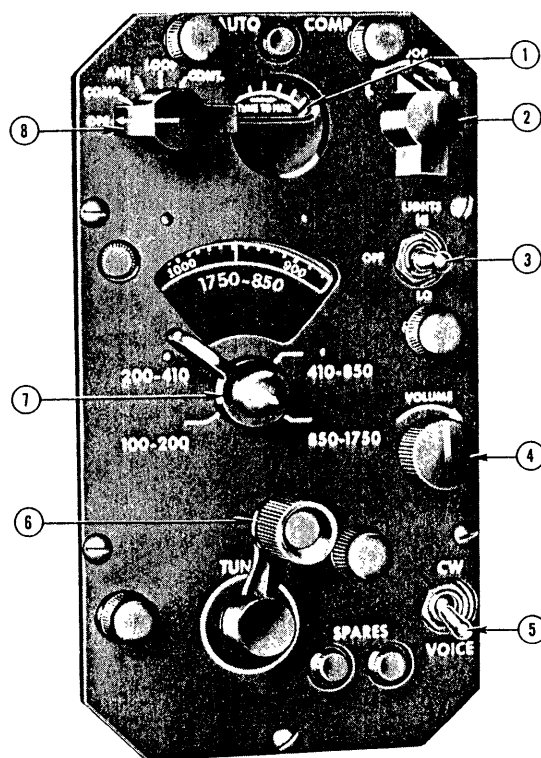

1. TUNING METER
2. LOOP ADJUSTMENT SWITCH
3. LIGHT SWITCH
4. AUDIO CONTROL KNOB
5. CW SELECTOR SWITCH
6. TUNING CRANK
7. FREQUENCY BAND SELECTOR
8. POWER SWITCH

Airplanes AF51-14314 through -15137 and -17354 and subsequent

168-71-794B

## RADIO COMPASS CONTROL PANEL

Figure 4-4

\* Airplanes AF51-14314 thru -14358, -14684 thru -15137, and -17354 and subsequent

## INTERPHONE CONTROLS.

**INTERPHONE SWITCH.** An interphone switch (11, figure 1-17; 10, figure 1-23) is located just above the throttle quadrant in each cockpit. On most airplanes,\* the switch may be manually held in the **MOMENTARY** (aft) position for short interphone transmission, or, if desired, the switch may be placed in the **CONTINUOUS** (forward) position for sustained interphone transmission. When the switch is in either position, the entire operation of the vhf command radio is overridden. Releasing the switch from the **MOMENTARY** (aft) position to the center position, or moving the switch from the **CONTINUOUS** (forward) position to the center position enables immediate interphone reception. On other airplanes† the switch can only be manually held in the **MOMENTARY** (aft) position for interphone transmission. The switch is released to enable immediate interphone reception. In addition, if the master selector switch is in the **MIX SIG & COMMAND** position, the vhf command set can be operated simultaneously with interphone operation.

**INTERPHONE VOLUME CONTROL KNOB.\*** An interphone volume control knob (10, figure 1-24) is located on the right console in the rear cockpit. The control knob is rotated to the right to increase volume during interphone communication.

### OPERATION OF INTERPHONE— PART OF SCR-522A.

1. Turn on vhf command radio.
2. Manually hold interphone switch in the aft **MOMENTARY** position, or place switch in forward **CONTINUOUS** position as desired to transmit.
3. Use microphone as in normal radio transmission.
4. To receive, release interphone switch or place switch in the center position, whichever is applicable.
5. Adjust interphone volume control knob to desired output.

### OPERATION OF INTERPHONE— USAF COMBAT TYPE.

1. Turn on vhf command radio.
2. With master selector switch at **MIX SIG & COMMAND**, place interphone switch at **INTER**.
3. Manually hold interphone switch in the **MOMENTARY** (aft) position to transmit.
4. Use microphone as in normal radio transmission.
5. To receive, release interphone switch.
6. Adjust master volume control knob for desired output.

\* Airplanes AF49-2897 thru -3537, AF50-1277 thru -1326, AF51-15138 thru -15237, and -16071 thru -16077

† Airplanes AF51-14314 thru -15137, and -17354 and subsequent

‡ Airplanes AF49-2897 thru -2981

§ Airplanes AF49-2982 thru -3537, AF50-1277 thru -1326, AF51-15138 thru -15237, and -16071 thru -16077



## VAR-ILS CONTROLS.

**ILS CONTROL PANEL.\*** The instrument landing system control panel, located on the right console of each cockpit, incorporates a volume control knob (17, figure 1-18; 11, figure 1-24) and a channel selector switch (15, figure 1-18; 5, figure 1-24). In addition to increasing volume, the control knob (on early airplanes‡) turns the set on when turned clockwise from its **OFF** position. On most airplanes§ the set is turned on when the channel selector switch is rotated clockwise from its **OFF** position.

**ILS CONTROL TRANSFER SWITCH.‡** A control transfer switch (6, figure 1-24), mounted on the right console in the rear cockpit, is provided to enable the rear cockpit occupant to control channel selection of the instrument landing system. For solo flight, the switch should be placed in the **FORWARD** position.

**ILS CONTROL TRANSFER PUSH BUTTON.§** A control transfer push button (18, figure 1-18; 11, figure 1-25), mounted on the instrument landing system control panel in each cockpit, is provided to enable either pilot to control channel selection of the instrument landing system.

**ILS COURSE REMINDER.\*** A course reminder (31, figure 1-13; 5, figure 1-21) is located above the approach indicator on the instrument panel in each cockpit. The course reminder, which can be set according to a given leg, is provided as a convenience to remind the pilot of the identity of each half of the localizer beam.

#### OPERATION OF THE INSTRUMENT LANDING SYSTEM.†

1. Place ILS control transfer switch to desired FRONT or REAR position.
2. Turn ILS volume control knob clockwise from the OFF position to turn set on.
3. Rotate ILS channel selector switch to desired channel and allow 30 seconds for set to warm up.
4. Adjust ILS volume control knob as desired.
5. Observe approach indicator, and set course reminder as necessary for visual or aural leg to be followed.

#### OPERATION OF INSTRUMENT LANDING SYSTEM.‡

1. Rotate ILS channel selector switch from the OFF position to desired frequency channel. This action also turns the set on.
2. Depress ILS control transfer push button to obtain control, and allow 30 seconds for set to warm up.
3. Adjust ILS volume control knob as desired.
4. Observe approach indicator, and set course reminder as necessary for visual or aural leg to be followed.

## EXTERIOR LIGHTS

### LIGHTING EQUIPMENT.

#### EXTERIOR LIGHT CONTROLS.

All exterior lights (landing, navigation, cowl, and passing) are controlled from the front cockpit only. See figure 4-5 for location of all exterior lights.

#### CAUTION

Do not leave landing or passing lights on for more than 10 seconds when airplane is on the ground, as excess heat may seriously damage the lights.

\*Airplanes AF49-2897 thru -3537, AF50-1277 thru -1326, AF51-15138 thru -15237, and -16071 thru -16077

†Airplanes AF49-2897 thru -2981

‡Airplanes AF49-2982 thru -3537, AF50-1277 thru -1326, AF51-15138 thru -15237, and -16071 thru -16077

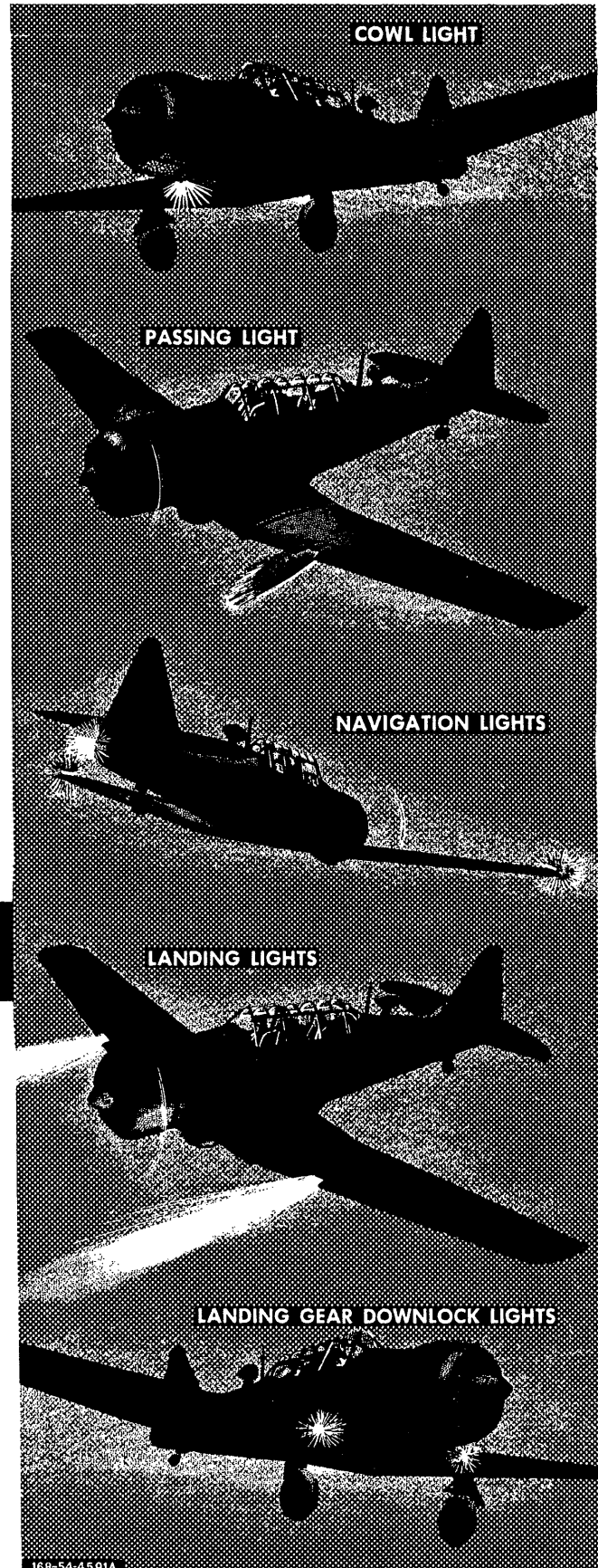

Figure 4-5

**LANDING LIGHT SWITCHES.** Landing lights, installed in the leading edge of each wing outer panel, are individually turned ON and OFF by switches (24, figure 1-15) located on the instrument subpanel in the front cockpit.

**NAVIGATION LIGHT SWITCH.** Navigation lights, located on the wing tips and tail, are controlled by a switch (27, figure 1-18; figure 4-6) located on the right console in the front cockpit. On most airplanes,\* the response of the navigation lights corresponds to the switch positions (FLASH or STEADY). However, on early airplanes,† the lights flash only (switch ON). Power to the landing gear downlock indicator lights is provided through the navigation light switch. The left wing lights are red, the right wing lights are green, and the taillights are white and amber. Brilliancy of the lights is controlled by a navigation and cowl light brilliancy switch.

**COWL LIGHT SWITCH.** A white cowl light, located under the engine section, is used in conjunction with the navigation lights. The light flashes when the cowl light switch (26, figure 1-18), located on the right console in the front cockpit, is positioned to the ON position and the navigation light switch is turned on. Brilliancy of the light is controlled by a navigation and cowl light brilliancy switch.

**NAVIGATION AND COWL LIGHT BRILLIANCY SWITCH.** Brilliancy of the navigation and cowl lights is controlled by a switch (25, figure 1-18) on the right console in the front cockpit. The switch has two positions, BRIGHT and DIM.

**PASSING LIGHT SWITCH.** A red passing light, installed in the leading edge of the left wing beside the landing light, is turned ON and OFF by a switch (7, figure 1-18) located on the right console in the front cockpit.

\* Airplanes AF49-3227 thru -3537, and AF50-1277 and subsequent  
 † Airplanes AF49-2897 thru -3226

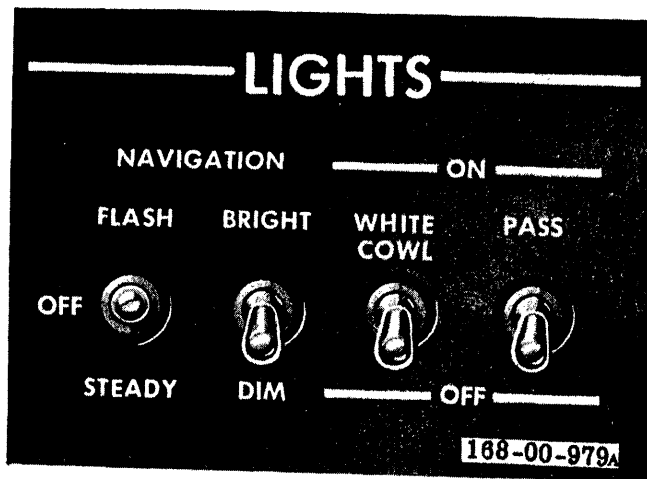

Airplanes AF49-3227 through -3537 and AF50-1277 and subsequent

## EXTERIOR LIGHTING PANEL

Figure 4-6

**INTERIOR LIGHT CONTROLS.**

**FLUORESCENT LIGHT CONTROL KNOBS.** The instrument panels are illuminated by fluorescent lights, one on each side of each cockpit. The lights are turned on and the brilliancy adjusted by a control knob (13, figure 1-17; 5, figure 1-18; and 4, figures 1-23 and 1-24) on the rear of each individual lamp. Each lamp can be removed from its bracket and held in any desired position.

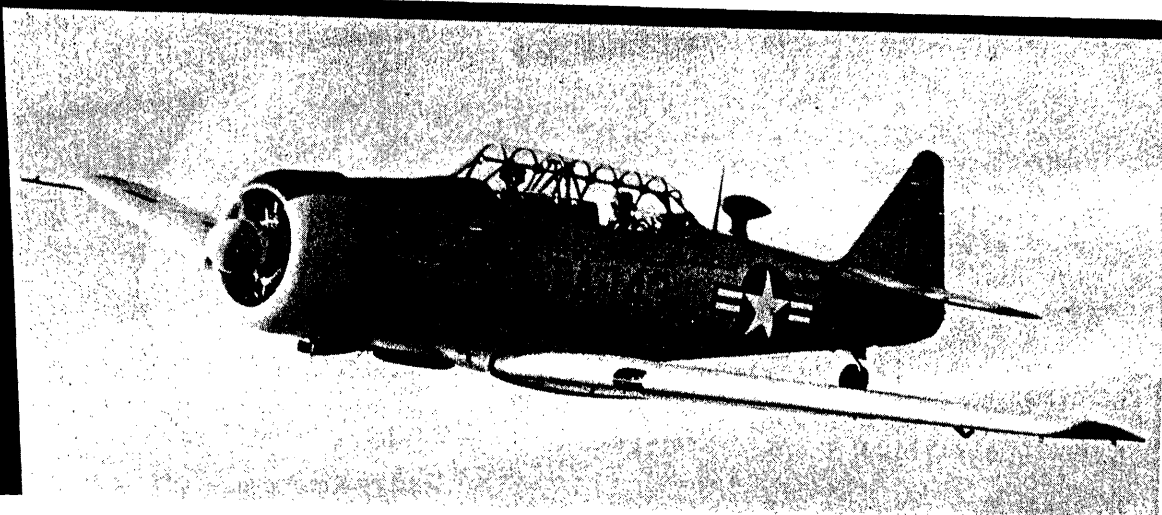

**COCKPIT LIGHT RHEOSTAT.** A cockpit light is located on each side of each cockpit to illuminate the respective consoles. Light illumination and brilliancy is controlled by a rheostat (10, figure 1-18; 13, figure 1-24), located on the right console in each cockpit.

**CONSOLE LIGHT RHEOSTAT.\*** A console light rheostat (27, figure 1-19; 2, figure 1-26) is located on the right console in each cockpit. The rheostats control lights that illuminate the respective radio control panels in each cockpit.

**FUEL QUANTITY GAGE LIGHT RHEOSTAT AND SWITCH.** Lights above each fuel quantity gage can be turned ON or OFF from either cockpit. The fuel quantity gage light is controlled from the front cockpit by a rheostat (9, figure 1-18) on the right console and from the rear cockpit by a spring-loaded switch (2, figure 1-24) on the right console. Light brilliancy can be controlled by the front cockpit rheostat only. The rear cockpit switch permits full brightness only, regardless of the position of the front cockpit rheostat.

**RADIO COMPASS CONTROL PANEL LIGHT RHEOSTAT.†** A rheostat (figure 4-3), labeled

"LIGHTS," is located at the top of the radio compass control panel in each cockpit. The rheostat turns on and regulates the brilliancy of the self-contained radio compass control panel lights. The rheostat moves clockwise from its off position, which is marked by a white radial line.

**RADIO COMPASS CONTROL PANEL LIGHT SWITCHES.\*** A switch (figure 4-4) labeled "LIGHTS," is located near the top of the radio compass control panel in each cockpit. The switch can be positioned from OFF to HI or LO for the desired light intensity of the self-contained radio compass control panel lights.

#### MISCELLANEOUS EQUIPMENT.

##### INSTRUMENT FLYING HOOD.

The rear cockpit incorporates provisions for an instrument flying hood (figure 4-7). The cockpit can be enclosed for instrument flight training by pulling the hood forward and engaging it with tie-down pins and spring clips at the instrument panel shroud. The hood, which is provided with a reel and cables to facilitate release, is stowed at the back of the cockpit when not in use.

\*Airplanes AF51-14314 thru -15137, and -17354 and subsequent

†Airplanes AF49-2897 thru -3537, AF50-1277 thru -1326, AF51-15138 thru -15237, and -16071 thru -16077

## INSTRUMENT FLYING HOOD AND CONTROL

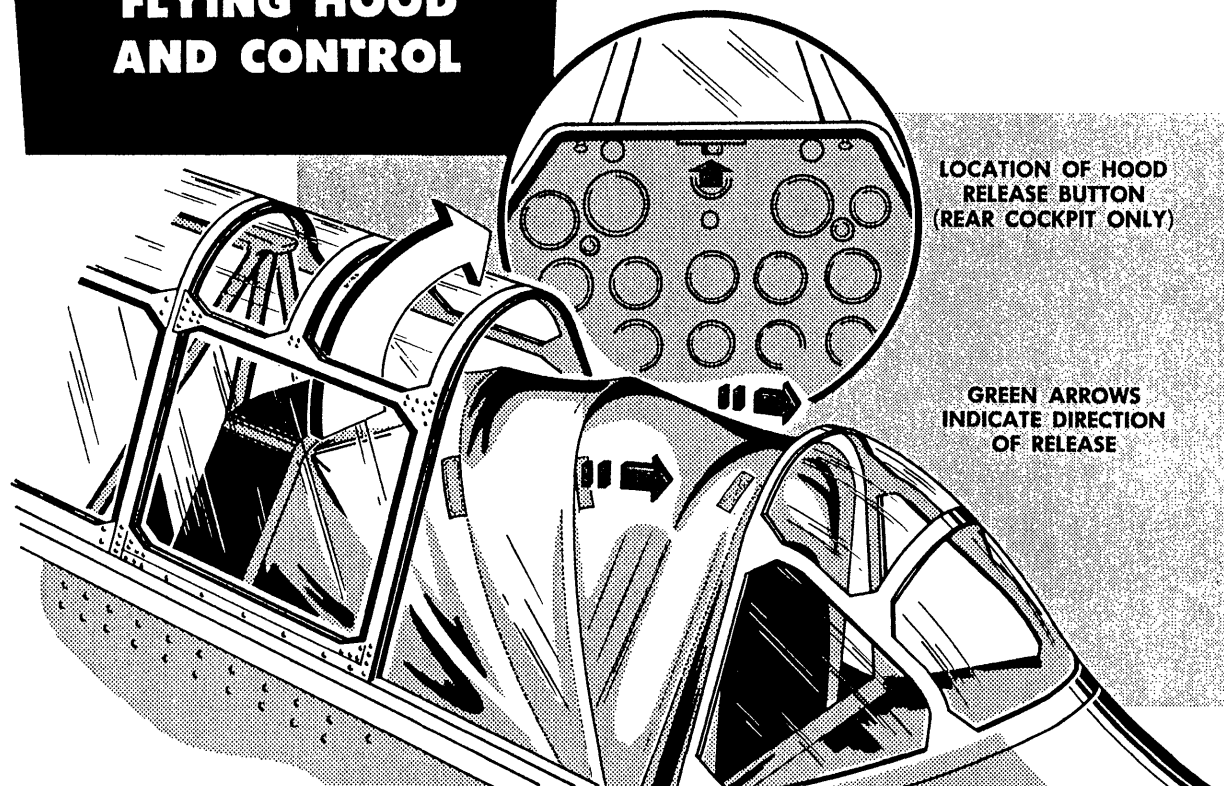

168-73-855

Figure 4-7



**INSTRUMENT FLYING HOOD RELEASE BUTTON.** A release button (10, figure 1-21), located below the top of the rear cockpit instrument panel shroud, is provided to enable release of the hood. When the release button is actuated, the tie-down pins disengage and the spring clips pull free.

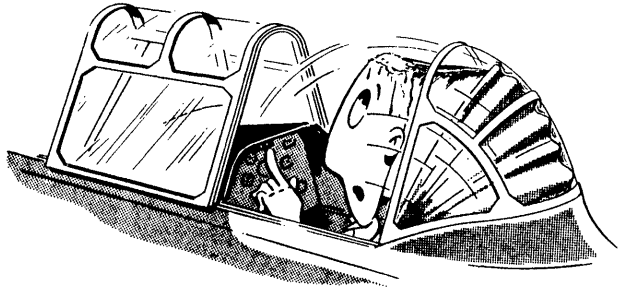

*Be sure that there is adequate head clearance before releasing instrument flying hood.*

### MAP AND DATA AND FLIGHT REPORT CASES.

A map and data case is provided on the right side of the front cockpit and a data case is provided in the rear fuselage. A flight report case is located in the front cockpit on the left, rear side of the pilot's seat.

### RELIEF TUBE.

A relief tube is attached to a bracket under the front cockpit seat and on the left side of the fuselage in the rear cockpit.

### ARMREST.

An armrest is provided on the left side of the front cockpit. The armrest is conveniently used when manipulating individual quadrant controls.

### REARVIEW MIRROR.

A rearview mirror is installed at the top right side of the windshield in the front cockpit.

### CHECK LISTS.

A Pilot's Training and Transition Check List, contained in a celluloid holder, is provided in each cockpit in a location that is convenient and has adequate clearance with all controls to prevent interference.







### OPERATING LIMITATIONS.

Some of the recommended operating conditions of the airplane or its component systems can be exceeded in the air or on the ground. The gages that indicate these operating ranges are marked in red to show the maximum safe limit. Instrument markings showing the various operating limits are illustrated in figure 5-1. The proper mixture control settings for the respective indicator readings are shown in figure 5-2. In some cases, the markings represent limitations that are self-explanatory and therefore are not discussed in the text. Operating restrictions or limitations which do not appear as maximum limits on the cockpit instruments are completely discussed in the following paragraph.

### MINIMUM CREW REQUIREMENTS.

Solo flight is permissible in this airplane; however, on solo flights the airplane must be flown from the front cockpit. Solo flight from the rear cockpit is prohibited because of insufficient controls and visibility restrictions.

### ENGINE LIMITATIONS.

All normal engine limitations are shown in figure 5-1. The maximum allowable engine overspeed is 2800 rpm for 30 seconds.

### WARNING

Whenever engine speed exceeds the operating limits, the airplane should be landed immediately at the nearest base. The reason for the overspeed (if known), the maximum rpm, and duration will be entered in Form 1 and reported to the maintenance officer. Overspeed between 2800 and 2900 rpm will necessitate an inspection of the engine before the next flight. If the rpm exceeded 2900, the engine will be removed for overhaul.

### PROPELLER LIMITATIONS.

Because of undesirable harmonic vibration frequencies, prolonged ground operation between 1450 and 1800 rpm is prohibited on airplanes equipped with round tip propeller blades. For the same reason, on airplanes equipped with square tip propeller blades, prolonged ground operation between 1800 and 1900 rpm is prohibited. This restriction does not apply during flight, because airflow through the propeller is directly from the front and does not set up any harmonic vibrations.

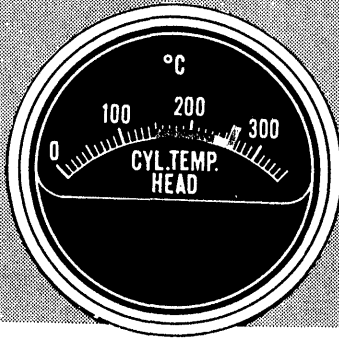

**CYLINDER HEAD TEMP**

|  |             |                       |
|--|-------------|-----------------------|
|  | 150°- 232°C | Manual Lean Permitted |
|  | 232°- 260°C | <b>RICH</b> Required  |
|  | 260°C       | Maximum               |

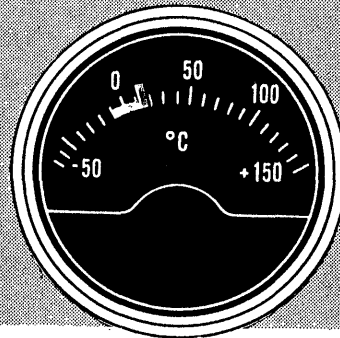

**CARBURETOR MIXT. TEMP**

|  |              |                                |
|--|--------------|--------------------------------|
|  | -10° to +3°C | Danger of Icing                |
|  | 3° to 15°C   | Continuous Operation           |
|  | 15°C         | Maximum - Danger of Detonation |

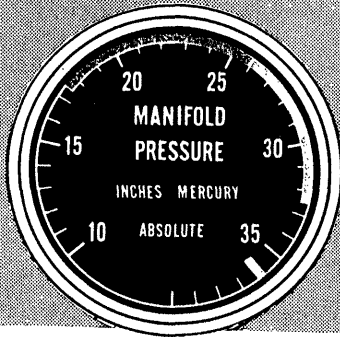
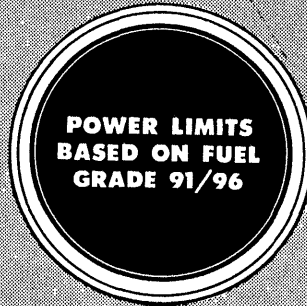

**MANIFOLD PRESSURE**

|  |                  |  |
|--|------------------|--|
|  | 17.5 in. Hg      | Minimum Recommended in Flight                                    |
|  | 17.5 - 26 in. Hg | Manual Lean Permitted  |
|  | 26 - 32.5 in. Hg | <b>RICH</b> Required   |
|  | 32.5 in. Hg      | Maximum Continuous (Operation above this point limited to 5 min) |
|  | 36 in. Hg        | Take-off (Military)  |

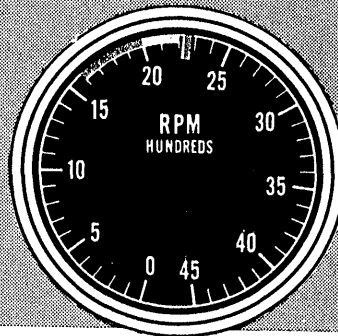

**TACHOMETER**

|  |                 |  |
|--|-----------------|--|
|  | 1600 rpm        | Minimum Recommended in Flight                                  |
|  | 1600 - 2000 rpm | Manual Lean Permitted  |
|  | 2000 - 2200 rpm | <b>RICH</b> Required   |
|  | 2200 rpm        | Maximum Continuous (Operation above this rpm limited to 5 min) |
|  | 2250 rpm        | Take-off (Military)  |

168-51-568A

Figure 5-1. Instrument Markings (Sheet 1 of 2)

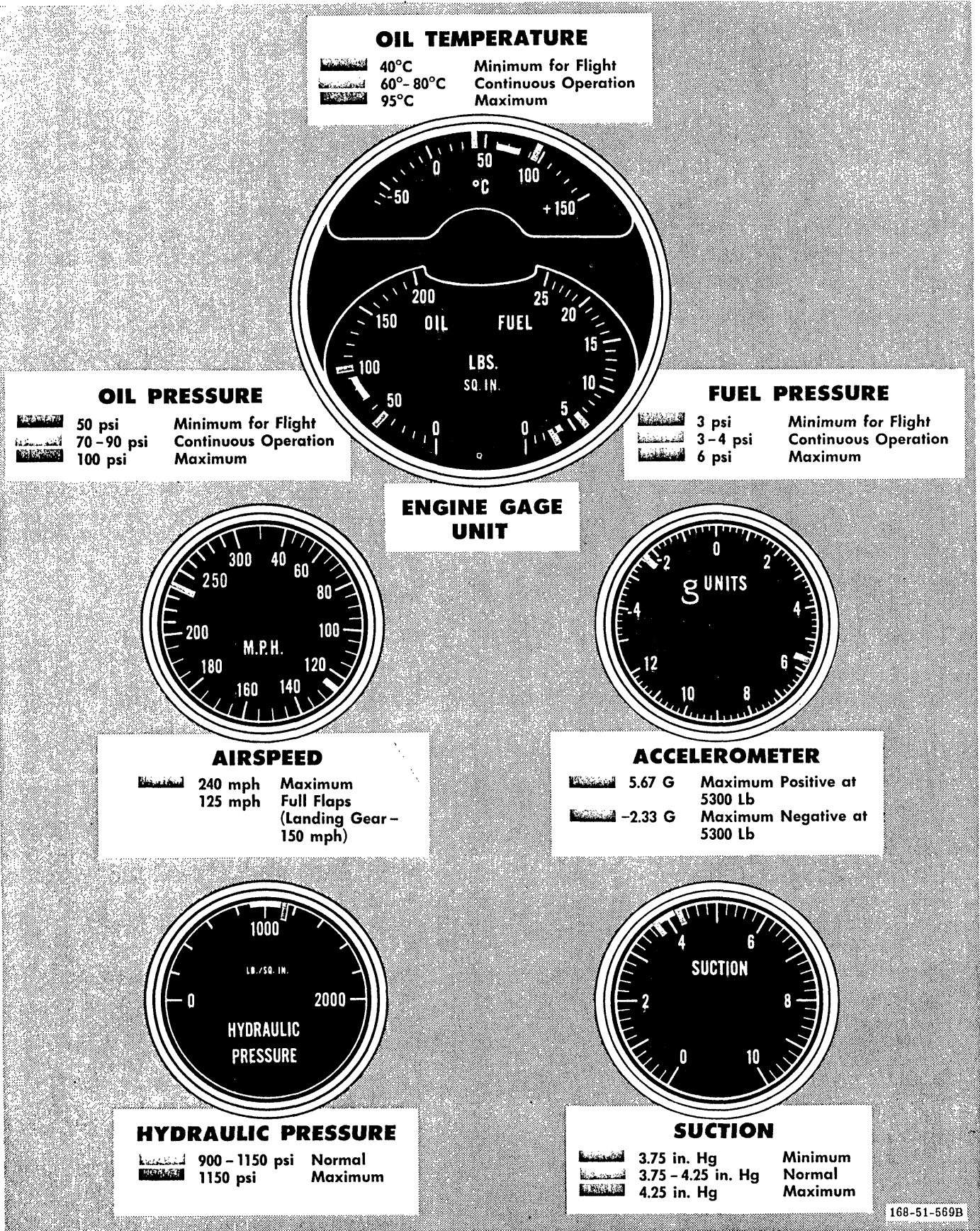

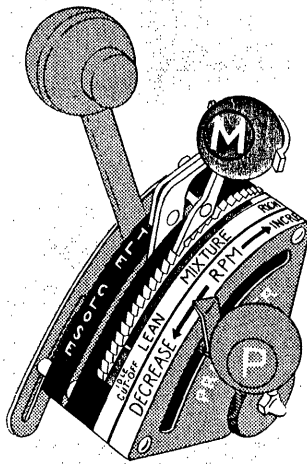

168-51-569B

Figure 5-1. Instrument Markings (Sheet 2 of 2)



### MIXTURE CONTROL

-  All Indicators in Blue—  
Operation in Manual  
Lean Permitted
-  Any Indicator (Manifold  
Pressure, Tachometer,  
or Cylinder Head Temp)  
in Green—**RICH** Re-  
quired
-  **IDLE CUT-OFF.**

168-43-241A

### MIXTURE CONTROL MARKINGS

Figure 5-2

### AIRSPPEED LIMITATIONS.

The red line on the airspeed indicator marks the limit dive speed at any altitude. However, the airplane should not be dived to airspeeds in excess of those where light to moderate airplane or surface control buffet is experienced. The yellow line indicates the maximum airspeed at which the flaps may be lowered to the full down position. The maximum airspeed for landing gear down is not marked on the airspeed indicator, but is given below the indicator on figure 5-1. Lowering either the flaps or gear at speeds in excess of the flaps-down or gear-down limit airspeeds may cause structural damage to the airplane. Because of the danger of accidental stalls, the minimum permissible indicated airspeed during sideslips is 90 mph.

### PROHIBITED MANEUVERS.

Outside loops, inverted spins, snap rolls in excess of 130 mph, and slow rolls in excess of 190 mph are prohibited. Inverted flight must be limited to 10 seconds, as there is no means of ensuring a continuous flow of fuel or oil in this attitude. Since altitude is lost rapidly during a sideslip, this maneuver should not be attempted below 200 feet.

### G-LOAD LIMITATIONS.

The airplane is limited to a maximum positive G-load of 5.67 and a maximum negative G-load of -2.33. These acceleration limits apply only when the clean airplane gross weight does not exceed 5300 pounds (design gross weight). When airplane gross weight is greater than 5300 pounds, the maximum allowable G-load is less than the maximum limit marked on the accelerometer. Remember that when you pull the maximum G-load (5.67 G), the wings of your airplane must support 5.67 times their normal load. This means that during a maximum G pull-out the wings of the airplane (at design gross weight) are supporting 5.67 times 5300 pounds or a total of approximately 30,000 pounds (the maximum that the wings can safely support). Therefore, when your airplane weighs more than 5300 pounds, the maximum G-load that you can safely apply can be determined by dividing 30,000 by the new gross weight. The maximum G-loads we have been talking about apply only to straight pull-outs. Rolling pull-outs are a different story, however, since they impose considerably more stress upon the airplane. The maximum allowable G-load in a rolling pull-out is limited to two-thirds the maximum G-load for a straight pull-out.

### OPERATING FLIGHT STRENGTH.

The Operating Flight Strength diagram (figure 5-3) shows the strength limitations of the airplane. Various G-loads are shown vertically along the left side of the diagram, and various indicated airspeeds are shown

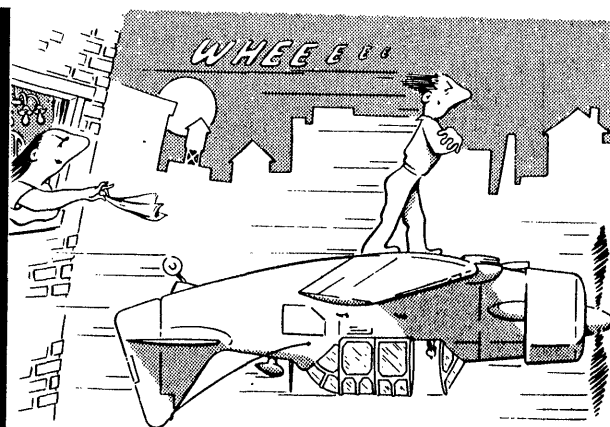

*All acrobatic maneuvers performed during training flights should be completed at least 5000 feet above the ground.*



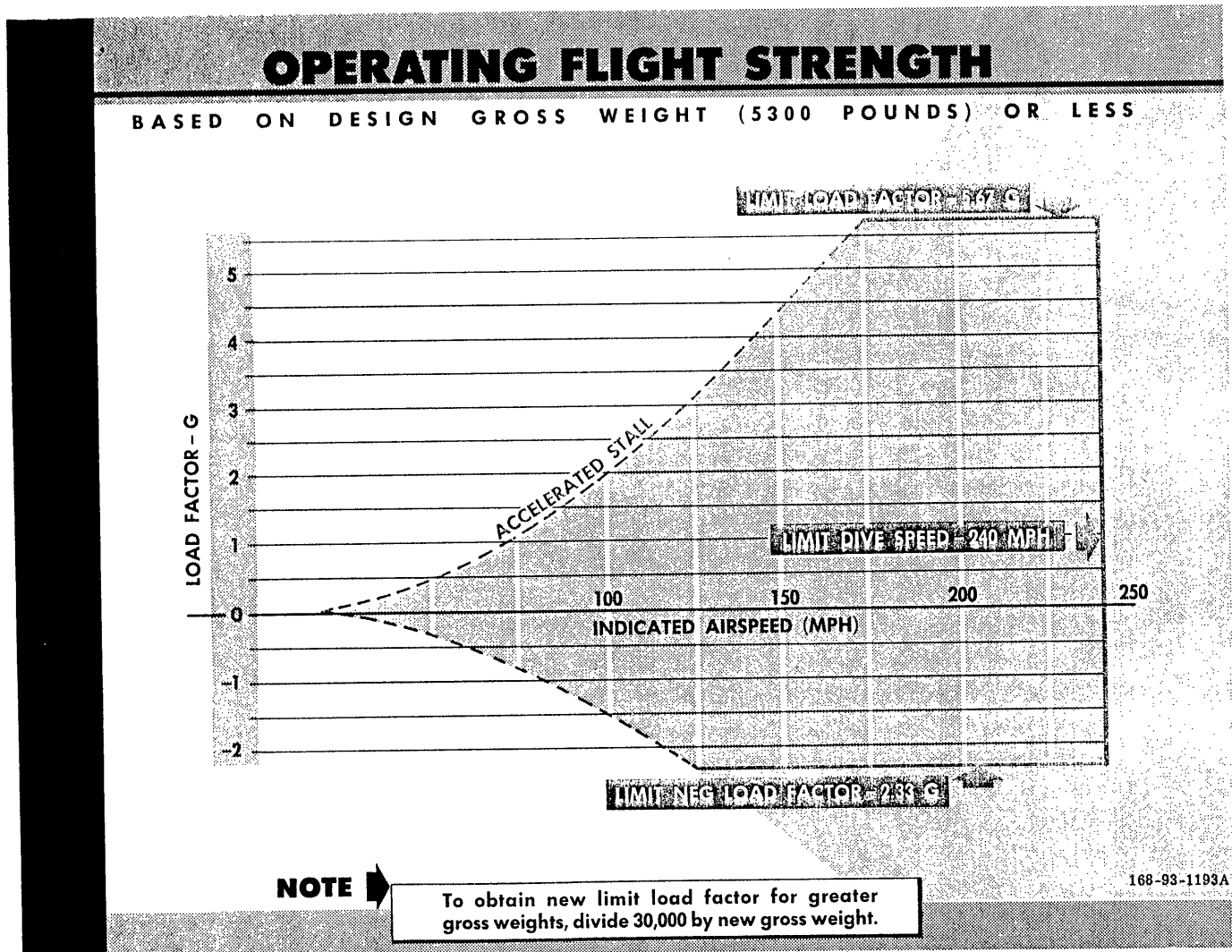

Figure 5-3

horizontally across the center of the diagram. The horizontal red lines at the top and bottom of the diagram represent the maximum positive and maximum negative allowable G-loads. The vertical red line indicates the limit dive speed of the airplane. The curved lines show the G-load at which the airplane will stall at various airspeeds. The upper curved line shows, for example, that at 100 mph the airplane will stall in a 2 G turn, while at 150 mph the airplane will not stall until more than 4 G is applied. The upper and lower limits at the right side of the diagram illustrate that the maximum positive and negative limit load factors (+5.67 G and -2.33 G) can be safely applied up to the limit dive speed of the airplane.

### CENTER-OF-GRAVITY LIMITATIONS.

The only adverse CG location that can occur is a tail-heavy condition caused by an excessive baggage load. This will result if more than 100 pounds of baggage is carried on a solo flight or, on flights with both pilots, when more than 15 pounds of baggage is carried on some airplanes\* or more than 35 pounds of baggage is carried on other airplanes.†

### WEIGHT LIMITATIONS.

The maximum allowable gross weight of the airplane cannot be exceeded. The baggage compartment should not be loaded in excess of its maximum capacity of 100 pounds.

\*AF49-2897 thru -3537, AF50-1277 thru -1326, AF51-15138 thru -15237, and -16071 thru -16077  
 †AF51-14314 thru -15137, and -17354 and subsequent

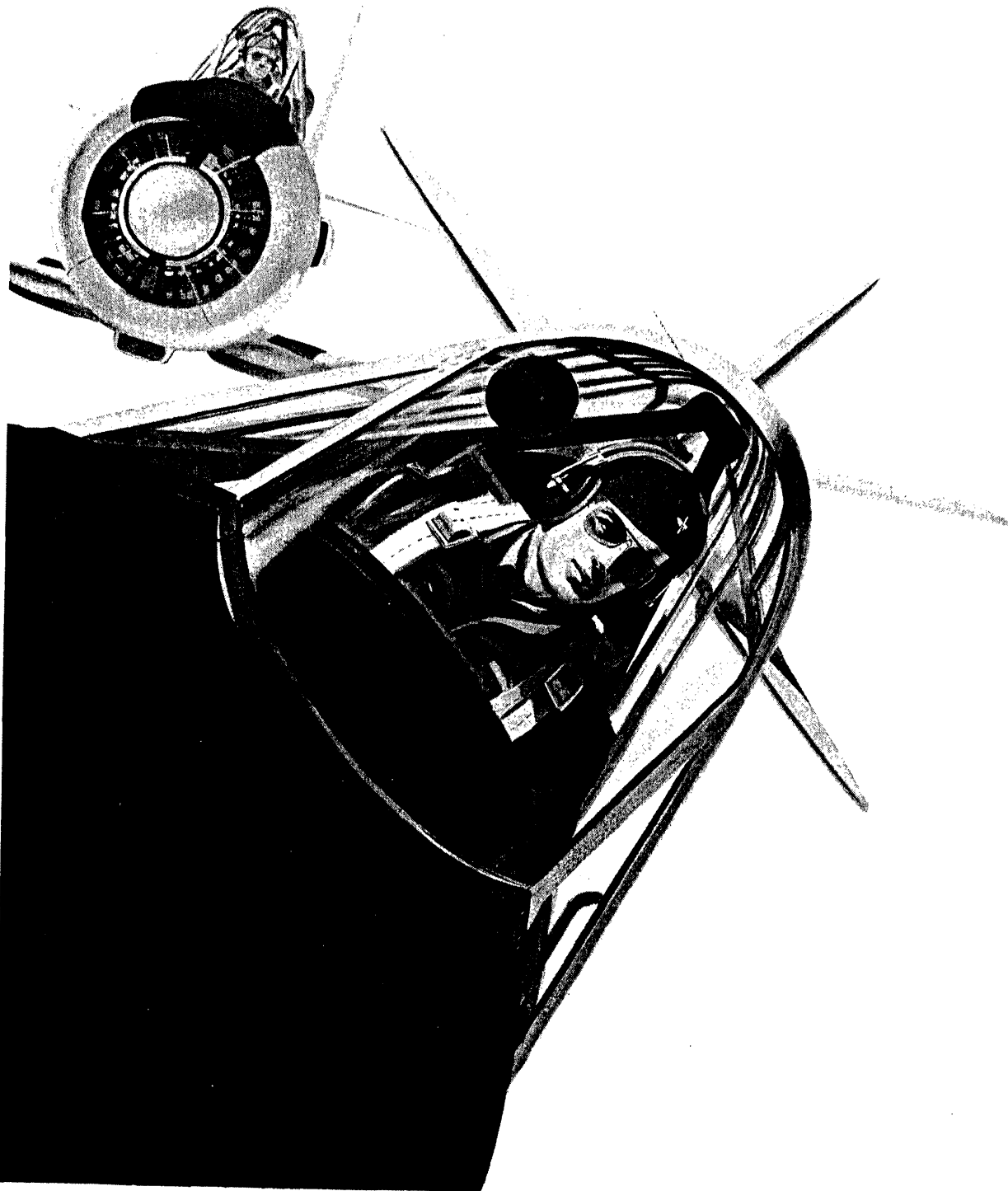

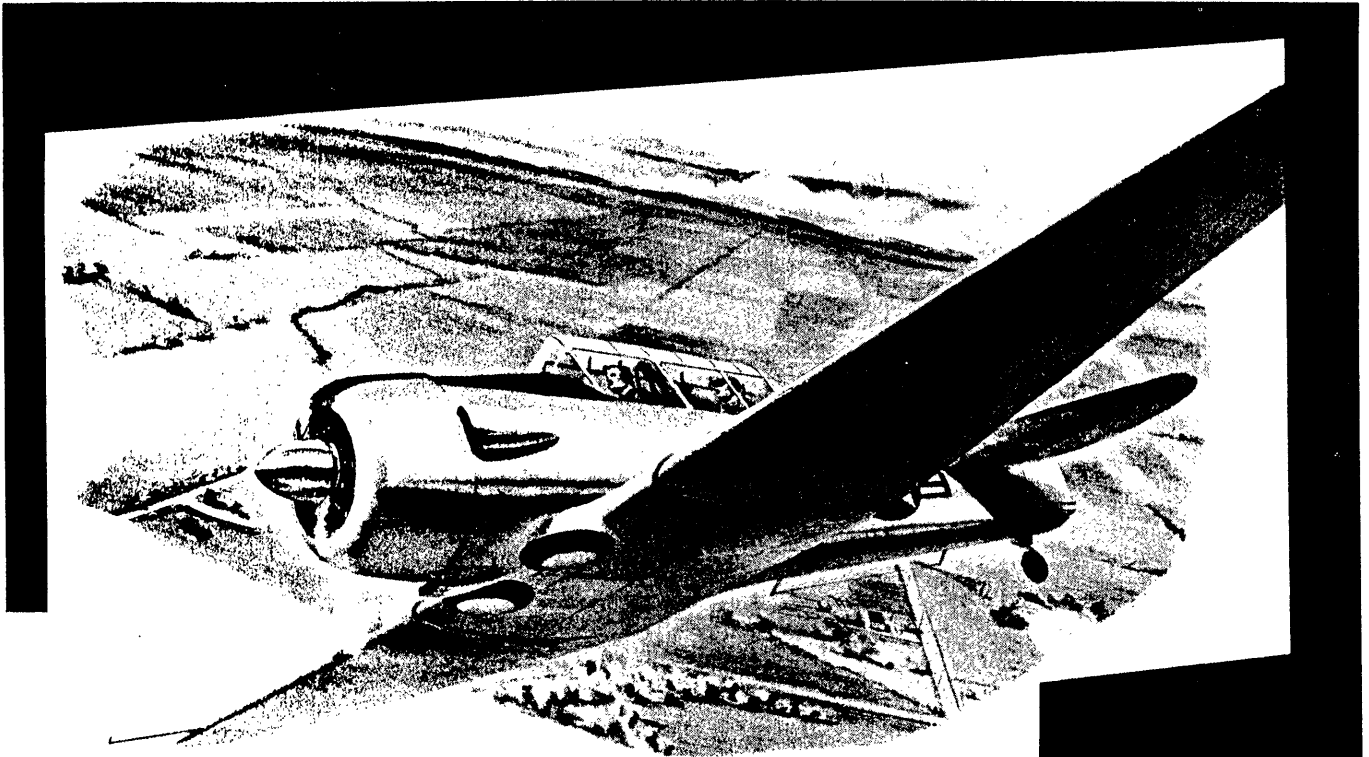

# *Flight Characteristics*

## SECTION VI

### **FLIGHT CHARACTERISTICS.**

The airplane has good stability and control characteristics and when properly trimmed will tend to maintain level flight.

### **MANEUVERING FLIGHT.**

Rapid airplane response to flight control movement during the normal speed range provides good acrobatic characteristics in this airplane. However, elevator stick forces in turns and pull-outs are purposely higher than elevator stick forces in fighter-type airplanes. This feature is to help you prevent imposing an excessive G-load on the airplane during acrobatics.

### **CAUTION**

Do not trim the airplane during any acrobatic maneuvers in an attempt to reduce stick forces, as only small elevator stick forces are then required to exceed the structural limits for the airplane.

### **FLIGHT CONTROLS.**

All flight controls are very effective throughout the normal speed range, and only moderate stick movement is

required to maneuver the airplane. At high speeds, the airplane response to control movement is greater than at cruise speeds, and abrupt movement of the controls must be avoided to prevent exceeding the G-limit of the airplane. Near stalling speeds the ailerons are least effective, the rudder is fairly effective, and the elevator is very effective. Rapid elevator movements at low speed should be avoided to prevent an unintentional stall. Elevator and rudder trim tab adjustments are sufficient to trim elevator stick forces and rudder pedal forces to zero throughout the normal speed range. Right rudder pedal force may be required during low-speed full-power conditions. The aileron trim tab is not adjustable from the cockpit.

### **SPINS.**

The airplane spin characteristics are illustrated in figure 6-1. The spin characteristics remain essentially the same whether the gear and flaps are up or down or whether the spin is to the left or the right. Some slight difference in the magnitude of the oscillations and canopy vibration may be noted. Normal spin entry is accomplished in the conventional manner by application



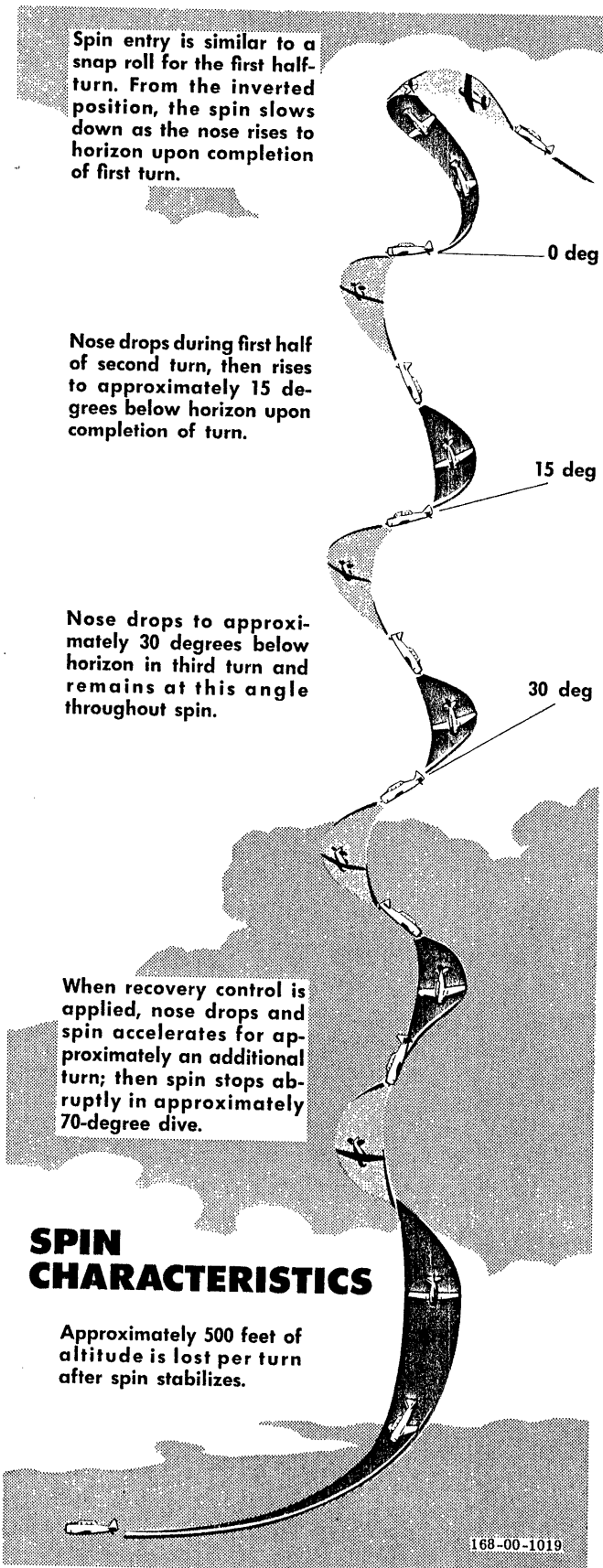

Figure 6-1

of full rudder in the desired direction at point of stall and simultaneous application of full back stick with ailerons neutral. These control positions must be held with the spin until the desired number of turns has been completed. The minimum altitude for intentionally entering a spin is 10,000 feet above the terrain. (Inverted spins are prohibited.)

#### SPIN RECOVERY.

Recovery from normal or inverted spins is effected by vigorous application of full opposite rudder followed by stick movement (slightly forward of neutral for normal spins and slightly aft of neutral for inverted spins). Leave ailerons neutral. Immediately following application of recovery controls, the nose of the airplane will drop and the spin will accelerate rapidly for approximately one-half to three-fourths turn. Hold the controls in this position until the spin stops; then immediately relax rudder pressure to neutral. Slowly apply back pressure on the stick to round out the dive and regain level-flight attitude. During the final recovery from an inverted spin, you may half-roll from the inverted dive before applying back pressure on the stick to round out the dive. Move throttle slowly to cruise setting after level-flight attitude is attained. Elevator stick forces during recovery will be lighter if the elevator trim adjustment is maintained for the level-flight cruise condition.

#### STALLS.

Stalls in this airplane are not violent. You can feel a normal stall approaching as the controls begin to loosen up and the airplane develops a sinking, "mushy" feeling. In addition, you can see the stalling attitude. When the stall occurs, there is a slight buffeting of the elevator and a vibration of the fuselage, and the nose or a wing drops. Stalling speeds with gear and flaps up or down—power on or off—with different gross weights at varying degrees of bank are given in figure 6-2. Conditions that affect stalling speeds and characteristics are shown in figure 6-3.

#### STALL RECOVERY.

The importance of proper stall recovery technique cannot be stressed too much. Because the elevator is very effective at stalling speeds, recovery is quick and positive. However, rough elevator use or failure to regain sufficient flying speed following a normal stall can cause an accelerated or high-speed stall. You can recover from partial stalls by reducing back pressure on the stick or by adding sufficient power to maintain control of the airplane. The standard procedure for recovering from a stall is as follows:

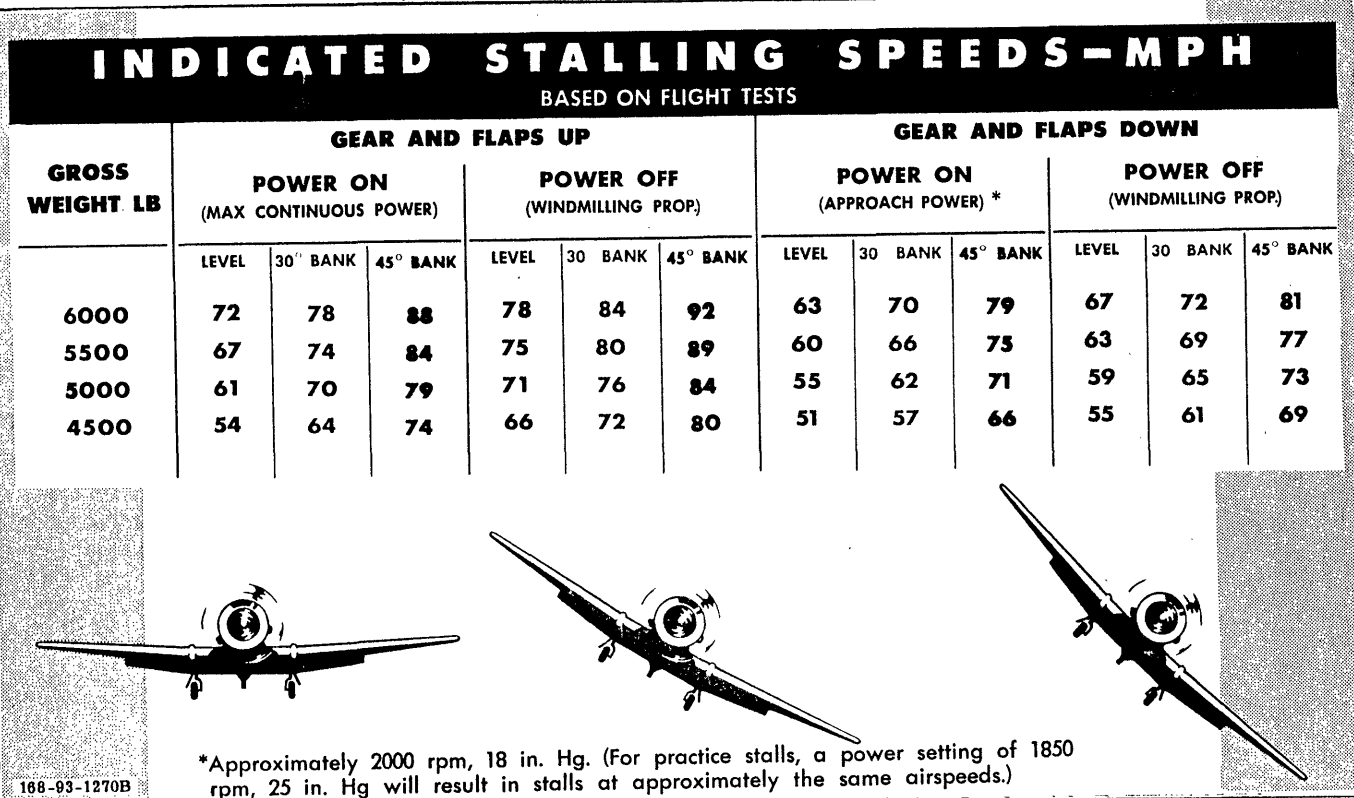

Figure 6-2

1. Move stick forward quickly and smoothly. To prevent an undesirable nose-low attitude and possible momentary engine stoppage, avoid jamming or snapping the stick forward abruptly.
2. At the same time, advance the throttle in a smooth movement to the sea-level stop.

**Note**

Be sure to move the stick and throttle together smoothly. Do not allow the nose to drop too far below the horizon.

3. Use rudder to maintain directional control. Ignore wing attitude until the stall is broken, at which time aileron effectiveness returns.
4. As soon as the stall is broken, utilize all controls in a co-ordinated manner to resume normal flight.
5. When you attain safe flying speed, raise the nose to level flight with steady back pressure on the stick. Avoid abrupt changes of attitude.
6. Retard throttle to cruising power after leveling off.

**PRACTICE STALLS.**

The following practice maneuvers will acquaint you with the stall traits and speed of the airplane under various flight conditions. For both power-on and power-off stalls, set the propeller control to obtain 1850 rpm. This

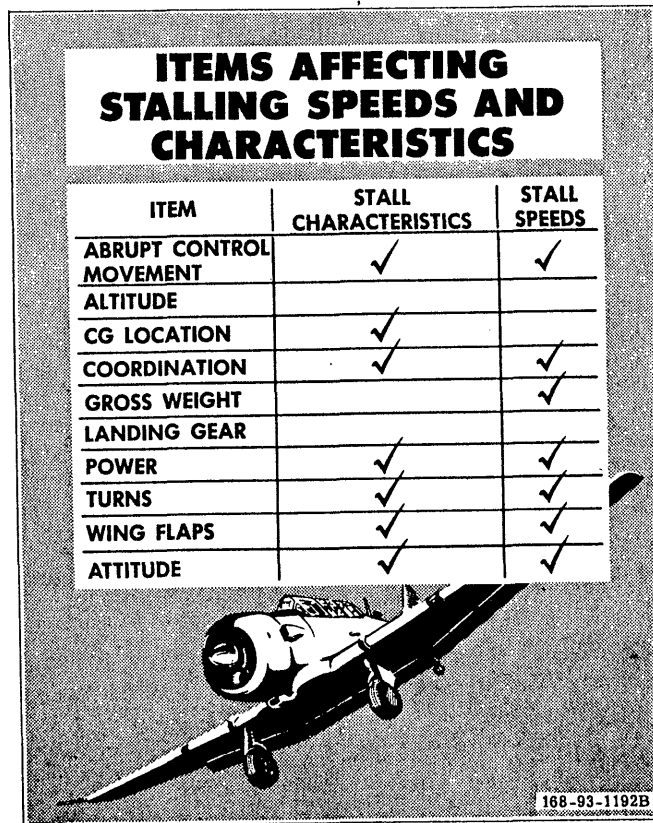
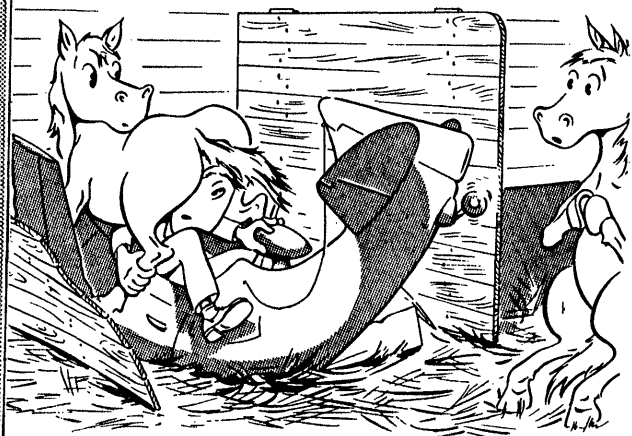

Figure 6-3

setting will prevent engine limitations from being exceeded accidentally during recovery. Retard the throttle smoothly for power-off stall; set manifold pressure at 25 in. Hg for power-on stalls. Canopies should be closed during practice stalls to prevent exhaust flame from entering cockpit in case of a backfire.



*Enter all stalls at a safe altitude above the ground. Recoveries should be completed at 4000 feet or higher above the terrain. Remember that considerable altitude can be lost in a stall maneuver.*

**PRACTICE STALL—GEAR AND FLAPS DOWN, POWER OFF, STRAIGHT AHEAD.** Set propeller control for 1850 rpm and mixture control for smooth operation. Close the throttle and maintain altitude. When airspeed approaches approximately 110 mph, lower full flaps. Establish a 90-mph glide and trim the airplane. Pull the nose up to a three-point attitude and hold until the stall occurs. Observe the qualities of the airplane in the stall. Note the *feel*. After the airplane breaks to the right or left or stalls straight ahead, per-

form a standard stall recovery as the nose passes through the horizon. Raise the landing gear and raise the flaps in slow stages as soon as possible. Retard the throttle to 25 in. Hg manifold pressure.

**PRACTICE STALL—GEAR AND FLAPS UP, POWER ON, STRAIGHT AHEAD.** Raise nose to approximately 40 degrees above the horizon. Hold this attitude with wings level and nose steady. As the stall approaches, observe the looseness of the controls, attitude of the airplane, and the tone of the engine. Notice how the airplane shudders when the stall occurs. As the stall occurs, apply brisk forward pressure to the stick and, at the same time, advance the throttle to the sea-level stop. Use rudder to maintain directional control; then blend in aileron as it becomes effective with the increase in airspeed. When flying speed is reached, ease airplane out of dive and back to cruising attitude and reduce throttle to 25 in. Hg manifold pressure.

**PRACTICE STALL—GEAR AND FLAPS UP, POWER ON, 20-DEGREE BANK.** Enter a coordinated climbing turn with a bank of approximately 20 degrees. Raise the nose approximately 40 degrees above the horizon. Keep the nose turning at a steady rate until the stall occurs. When the stall occurs, apply brisk forward pressure to the stick and advance the throttle to the sea-level stop. When you have enough flying speed to make ailerons effective, make a coordinated roll out of the turn and dive. Return to level flight as in straight-ahead stalls. Reduce throttle to 25 in. Hg manifold pressure.

**PRACTICE STALL—GEAR DOWN, FLAPS UP, POWER OFF, STRAIGHT AHEAD.** Close throttle completely, reduce airspeed to 100 mph IAS, and establish a normal glide. Retrim. Raise the nose to a landing attitude and hold it on a point straight ahead until the stall occurs. As you approach the stall, observe the looseness of controls, the "mushy" feeling of the airplane, and the dwindling airspeed. Remember, this is like a landing stall. Use standard recovery procedure. Reduce throttle to 25 in. Hg manifold pressure and raise the landing gear.

**PRACTICE STALL—GEAR DOWN, FLAPS UP, POWER OFF, 40-DEGREE BANK.** This maneuver will help you recognize the stalls which may occur in power-off turns in traffic or landings. Assume a normal glide of 100 mph; then roll into a medium gliding turn with about 40 degrees of bank. Maintain a steady turn, raising the nose slightly until it is just above the horizon. It is necessary to increase back pressure on the stick to hold this attitude until the stall occurs. Make a standard recovery. After recovering speed, use coordinated controls to level the airplane. Reduce the throttle to 25 in. Hg manifold pressure and raise the landing gear.

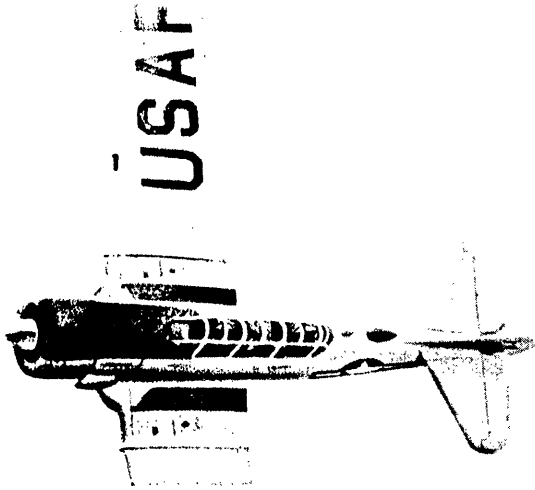

### DIVES.

The handling characteristics in dives to the limit air-speed are good. All control movement is easy and effective, and the airplane responds rapidly. If you trim the airplane for level flight at Maximum Continuous Power, the tab settings will be satisfactory for diving, although some adjustment of rudder tab may be desired during the dive so that you will not have to hold rudder. The amount of forward stick pressure required to hold the airplane in a dive is relatively small, as is the amount of aileron pressure needed to keep the wings level. To determine the altitude lost in a constant 4 G pull-out dive recovery, see figure 6-4. Before entering a dive, close the canopy and position the carburetor air control to COLD. Decrease rpm as necessary during the dive to prevent exceeding maximum engine overspeed limits.

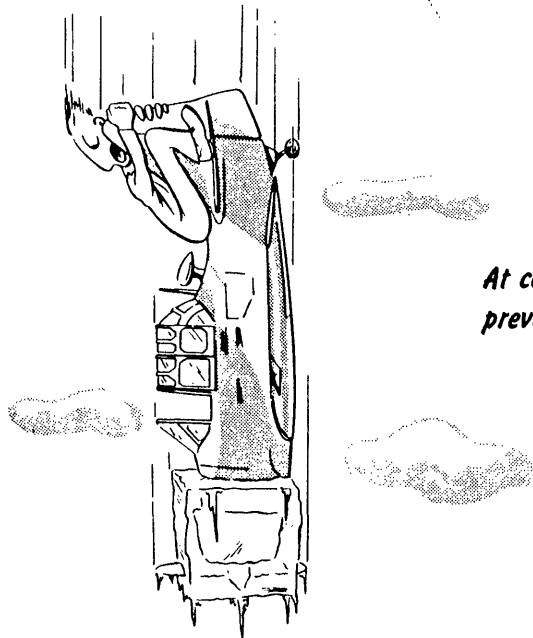
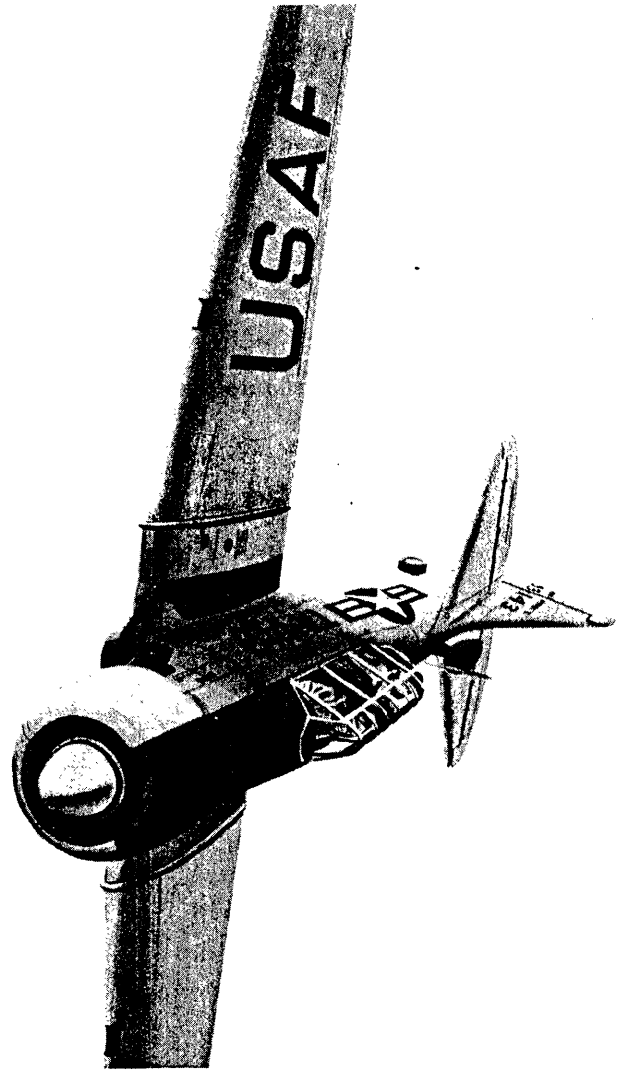

*At completion of dive, open throttle slowly to prevent partly cooled engine from cutting out.*

### ALTITUDE LOSS CONSTANT 4G PULL-OUT

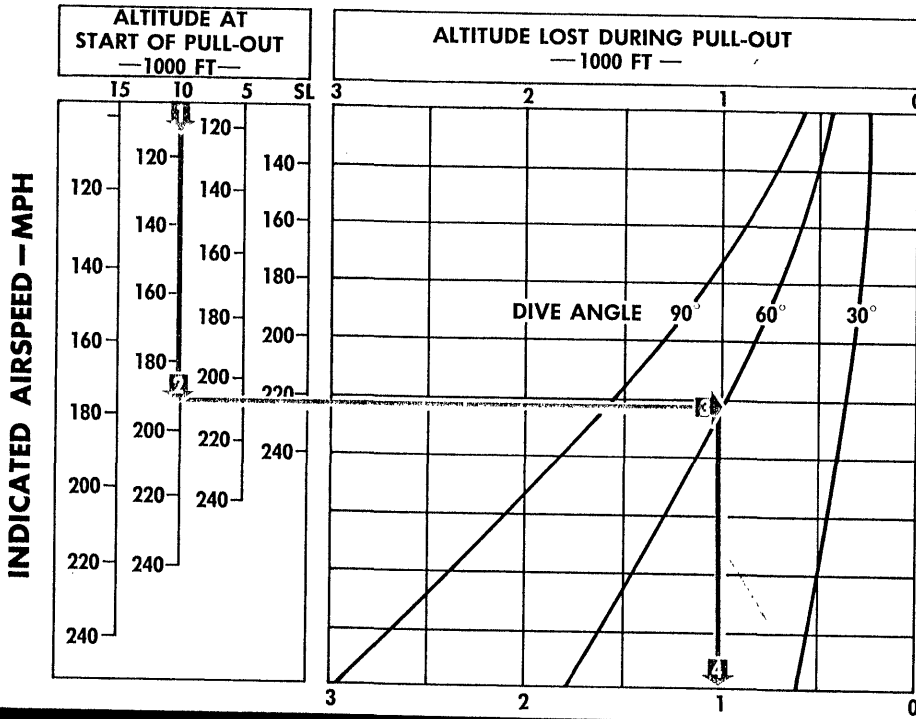

#### HOW TO USE CHART

- Enter chart at altitude line nearest actual altitude at start of pull-out (example, 10,000 feet).
- On scale along altitude line, select point nearest the IAS at which pull-out is started (190 MPH).
- Sight horizontally to point on curve of dive angle (60 degrees).
- Sight vertically to read altitude lost during constant 4G pull-out (1000 feet).

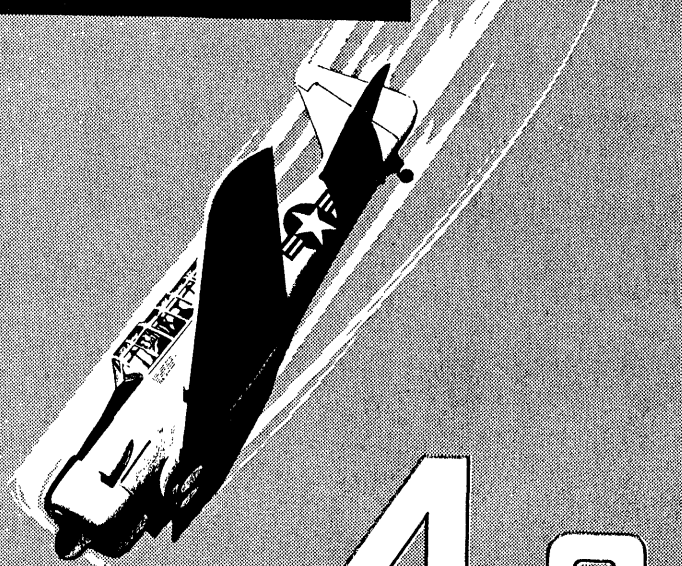

# 4 G

**PULL-OUT**

168-93-1178

Figure 6-4. Altitude Loss in Dive Recovery—4 G





## SECTION VII

# Systems Operation

### ENGINE.

#### USE OF TAKE-OFF (MILITARY) POWER.

It is often asked what the consequences would be if the 5-minute limit at Take-off Power were exceeded. Another frequent inquiry is how long a period must be allowed after the specified time limit has elapsed until Take-off Power can again be used. These questions are difficult to answer, since the time limit specified does not mean that engine damage will occur if the limit is exceeded. Instead, the limit means to keep the total operating time at high power to a reasonable minimum in the interest of prolonging engine life.

It is generally accepted that high-power operation of an engine results in increased wear and necessitates more frequent overhaul than low-power operation. However, it is apparent that a certain percentage of operating time must be at full power. The engine manufacturer allows for this in qualification tests in which much of the running is done at Take-off Power to prove ability to withstand the resulting loads. It is established in these runs that the engine will handle sustained high power without damage. Nevertheless, it is still the aim of the manufacturer and to the best interest of the pilot to keep within reasonable limits the amount of high-power time accumulated in the field. The most satisfactory method for accomplishing this is to establish time limits that will keep pilots constantly aware of the desire to hold high-power periods to the shortest period

that the flight plan will allow, so that the total accumulated time and resulting wear can be kept to a minimum. How the time at high power is accumulated is of secondary importance; i.e., it is no worse from the standpoint of engine wear to operate at Take-off Power for one hour straight than it is to operate in twelve 5-minute stretches, provided engine temperatures and pressures are within limits. In fact, the former procedure may even be preferable, as it eliminates temperature cycles which also promote engine wear. Thus, if flight conditions occasionally require exceeding time limits, this should not cause concern so long as constant effort is made to *keep the over-all time at Take-off Power to the minimum practicable.*

Another factor to be remembered in operating engines at high power is that full Take-off Power is to be preferred over take-off rpm with reduced manifold pressure. This procedure results in less engine wear for two reasons. First, the higher resulting brake horsepower decreases the time required to obtain the objective of such high-power operation. At take-off, for example, the use of full power decreases the time required to reach an altitude and airspeed where it is safe to reduce power and shortens the time required to reach the airspeed that will provide more favorable cylinder cooling. Second, high rpm results in high loads on the reciprocating parts because of inertia forces. As these loads are partially offset by the gas pressure in the cylinder, the higher cylinder pressures resulting from use of full take-off manifold

pressure will give lower net loads and less wear. Sustained high rpm is a major cause of engine wear. It requires more "rpm minutes" and "piston-ring miles" to take off with reduced manifold pressure. In addition to the engine wear factor, a take-off at reduced power is comparable to starting with approximately one-third of the runway behind the airplane. Therefore full power should *always* be used on all take-offs.

#### MANUAL LEANING.

An important factor affecting engine power output is the fuel-air ratio of the inlet charge going to the cylinders. Since air density decreases with altitude, the mixture control must be manually adjusted to maintain a proper mixture. However, lean mixtures must be avoided, especially when the engine is operating near its maximum output. It is well to closely observe the cylinder head temperature whenever lean mixtures are used. If the mixture is too lean, one or more of the following operational difficulties may result: rough engine operation, backfiring, overheating, detonation, sudden engine failure, or appreciable loss in engine power. Adjusting the mixture for smooth operation is accomplished by slowly pulling the mixture control toward LEAN until the engine definitely falters; immediately push the control slightly forward until the engine again runs smoothly. Then slowly push the control approximately  $\frac{1}{8}$  inch toward RICH.

#### THROTTLE "JOCKEYING."

Since there is no advantage to "jockeying" the throttle, and because it can result in damage to the engine, it should be avoided. "Jockeying" the throttle when the engine is cold frequently causes backfire with accompanying fire hazard. When the engine is hot, "jockeying" the throttle will tend to "load up" and possibly choke the engine.

#### CHANGING ENGINE POWER SETTINGS.

One of the basic limitations placed on engine operation is imposed by the amount of pressure developed in the cylinders during combustion. If this pressure becomes excessive, it can cause detonation and will result in eventual engine failure. Since improper coordination in the use of the throttle and propeller control can cause these limitations to be exceeded, it is important to learn the correct sequence in which these controls should be used. *Whenever the engine power is to be reduced, retard the throttle first; then retard the propeller control. Conversely, when increasing engine power, advance the propeller control first; then advance the throttle.*

#### CARBURETOR ICING.

A characteristic of carburetor icing is that ice will form more readily when the *mixture* temperature in the carburetor is between  $-10^{\circ}\text{C}$  and  $+3^{\circ}\text{C}$ . Carburetor icing usually occurs during times when the *free air* temperature is about  $+4^{\circ}\text{C}$  to  $+8^{\circ}\text{C}$ . Ice will also form more readily when the engine is operated under a low-power

cruise condition; therefore, a higher power setting should be selected when icing conditions are prevalent. The formation of ice can be detected by a gradual decrease of manifold pressure, but rpm will remain constant, as the propeller governor will automatically maintain the existing rpm setting. Moving the carburetor air control to HOT will eliminate the ice in the carburetor, and the manifold pressure will return almost to the original setting. During operation in cold, clear nonicing air where cylinder head and carburetor mixture temperatures drop to values low enough to cause rough engine operation, carburetor heat should be increased just enough to eliminate the roughness.

#### DETONATION.

Detonation is the result of one type of abnormal combustion of part of the fuel-air mixture. The other prevalent form of abnormal combustion is preignition. When detonation occurs, combustion is normal until approximately 80 percent of the charge is burning. At that point, the rate of combustion speeds up tremendously, resulting in an explosion or nearly instantaneous combustion. This explosion actually pounds the cylinder walls, producing "knock." This "knock," or pounding of the cylinder walls, can cause an engine failure. In an airplane, the "knock" is not heard because of other engine and propeller noises. However, detonation can be detected by observing the exhaust for visible puffs of black smoke, glowing carbon particles, or a small, sharp whitish-orange flame. In addition, a rapid increase in cylinder head temperatures often indicates detonation. When detonation is evident, throttle reduction is the most immediate and surest remedy. *When detonation occurs, power is lost.* Contributing causes of detonation are as follows:

1. Low octane fuel.
2. High cylinder head temperature caused by too long a climb at too low an airspeed or by too lean a mixture.
3. High mixture temperature caused by use of carburetor heat or by high outside air temperature.
4. Too high manifold pressure with other conditions favorable to detonation.
5. Improper mixture caused by faulty carburetor or too lean a mixture.

#### PREIGNITION.

Preignition is closely related to detonation. In fact, detonation often progresses into preignition. When the engine gets too hot, the mixture is ignited before the spark occurs. When this happens, much of the power is wasted trying to push the piston down while it is still rising in the cylinder. The power impulses are uneven, horsepower falls off, and the engine can be damaged from excessive pressures and temperatures. Preignition may be detected by backfiring through the carburetor and possibly by a rapid increase in cylinder head temperatures. When preignition is encountered, the throttle setting should be reduced immediately.



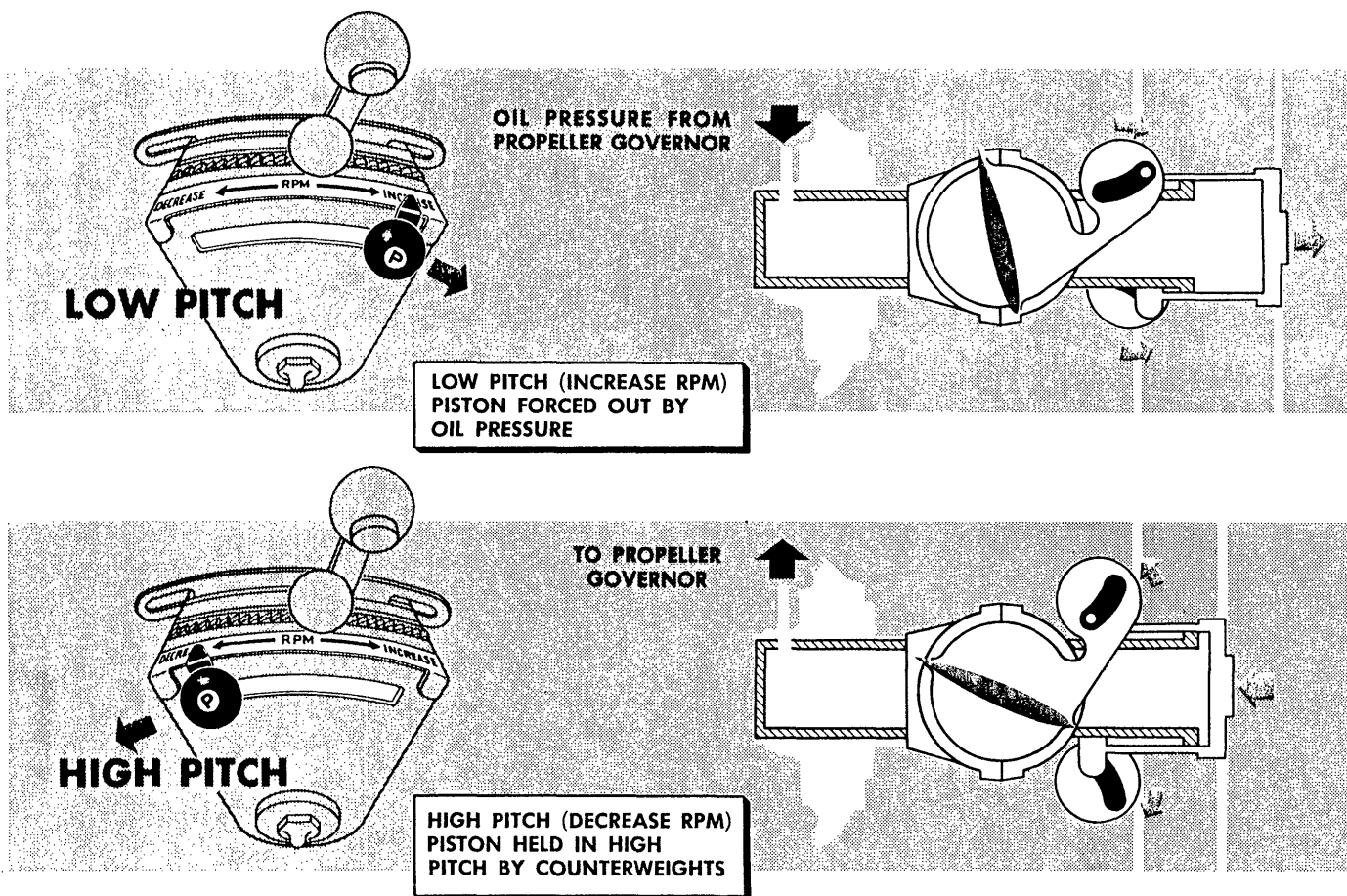

Since the engine is shut down with propeller at **DECREASE** rpm, it must be started at **DECREASE** rpm to ensure proper engine lubrication during starting.

168-44-260B

## PROPELLER OPERATION

Figure 7-1

### FUEL SYSTEM FLIGHT OPERATION.

During flight, the fuel selector should be moved alternately between 70 GAL LEFT and 70 GAL RIGHT to keep the fuel level in the wing tanks within 10 gallons of each other. When flying below 3000 feet above the ground, it is advisable to select the tank containing more fuel as a safety precaution against inadvertent fuel starvation. Because of fuel cell baffle and flapper valve design, banking maneuvers can "stuff" fuel into the cell enclosure from which fuel quantity is determined. Therefore, the actual quantity of fuel may be less than that indicated on the gage.

### PROPELLER OPERATION.

The relationship between propeller pitch (blade angle),

counterweight and propeller piston position, and function of engine oil pressure is schematically shown on figure 7-1. The engine speed is maintained constant by a governor, which regulates the engine oil pressure to a piston incorporated in the propeller hub. A counterweight at the shank of each blade provides a force (proportionate to rpm) in opposition to engine oil pressure to effect a balance. The resultant action of the piston varies the propeller blade angle or pitch, thereby maintaining a constant engine rpm. The engine is shut down with the propeller at decrease rpm (high pitch) so that the oil in the hub piston will be returned to the oil tank. Therefore, the propeller control must be at DECREASE rpm when the engine is again started; otherwise, the immediate demand for oil to change the propeller pitch will decrease the available oil pressure necessary for engine lubrication during the start.

**SECTION VIII**  
*Crew Duties*

**NOT APPLICABLE  
TO THIS AIRPLANE**

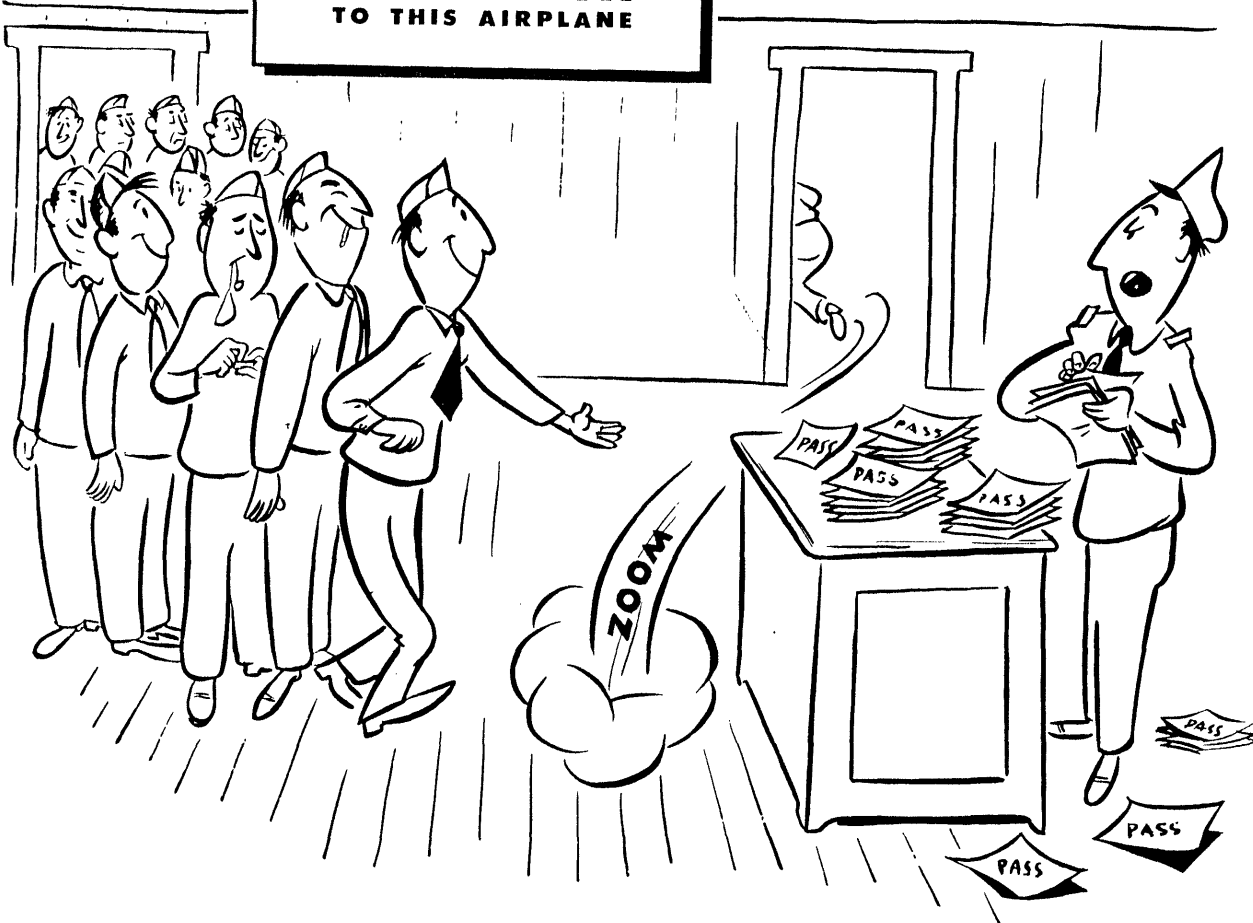

# All-Weather Operation

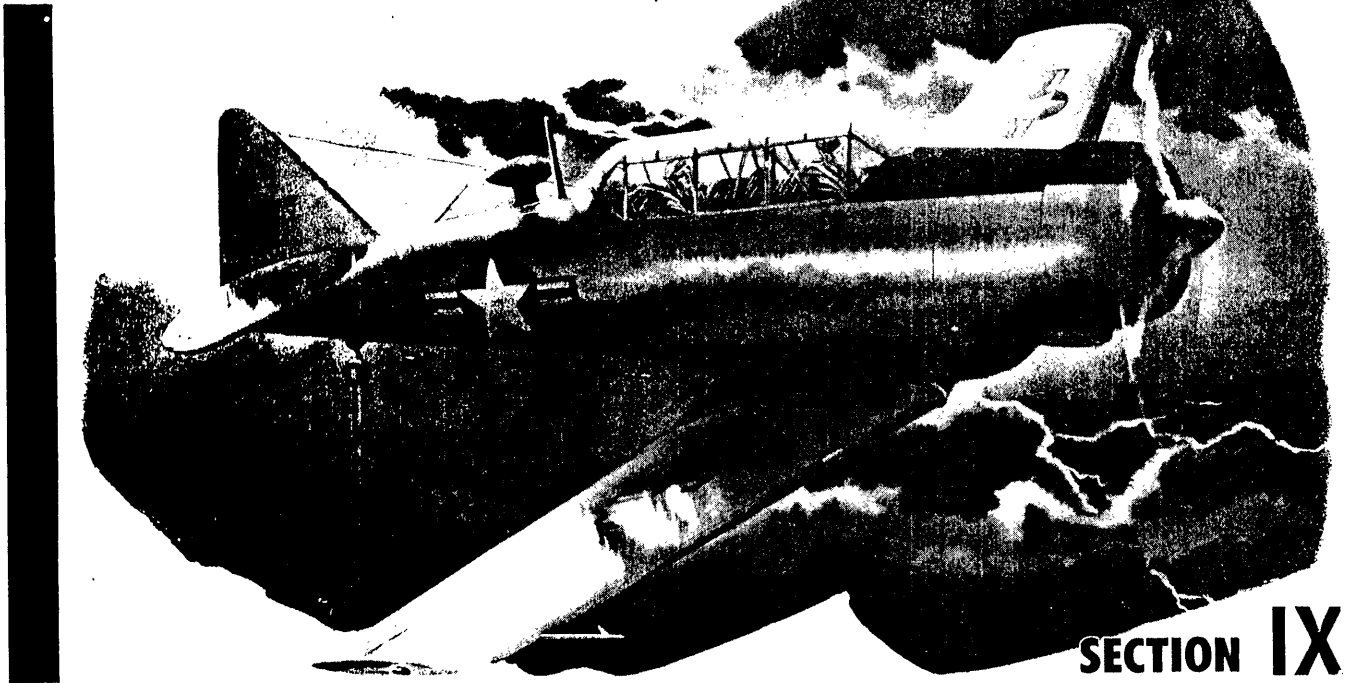

Except for some repetition necessary for emphasis or continuity of thought, this section contains only those procedures that differ from, or are in addition to, the normal operating instructions contained in Section II.

## NIGHT FLYING

There are no predominant differences between night flying procedures and day flying procedures. Exhaust glare will obviously be more pronounced during night flights, but should be no cause of alarm. Refer to Section II for night flight interior check, take-off, and landing procedures.

## INSTRUMENT FLIGHT PROCEDURES

Stability and rapid acceleration or deceleration are the outstanding instrument flight characteristics of the airplane. All the necessary flight instruments are provided. In an emergency, flight on the basic flight instruments (turn-and-bank indicator and airspeed indicator) can be safely accomplished. Radio compass, range reception, vhf transmission, and vhf reception are all provided in addition to interphone communication between cockpits. Remember, since power settings are somewhat higher during certain phases of instrument flight, the airplane range will be slightly decreased.

### Note

All turns are single-needle-width standard rate (3 degrees per second) turns.

### PRIOR TO TAKE-OFF.

1. Check G file for inclusion of AN 08-15-1 (Radio Facilities Charts), AN 08-15-2 (USAF Radio Data and

Flight Information), and Pilot's Handbooks—Continental United States.

2. Check suction gage for proper indication.

3. Check that the pitot head cover has been removed. Turn pitot heater on and have outside observer verify its operation. Turn pitot heater off until just before take-off.

4. Check airspeed indicator needle at zero. Check airspeed correction card for any deviation at the speed range to be flown.

5. If the directional gyro has been actuated for at least 5 minutes, the rotor will have attained proper operating speed. The dial card should revolve with the knob when the gyro is caged but not when the gyro is uncaged. Set the directional gyro so that it corresponds to the reading of the magnetic compass.

6. If the gyro horizon has been actuated for at least 5 minutes, the rotor will have attained proper operating

speed. Cage the instrument and then uncage it. After the instrument is uncaged, the horizon bar should return to the correct position for the attitude of the airplane. Temporary vibration of the horizon bar is permissible.

#### Note

If the horizon bar temporarily departs from horizontal position while the airplane is being taxied straight ahead, or if the bar tips more than 5 degrees during taxiing turns, the instrument is not operating properly.

7. Obtain station altimeter setting (sea level barometric pressure) from control tower operator. When altimeter is set, the pointers should indicate local field elevation. If the altimeter registers within 75 feet, it may be used, provided the error is properly considered when the instrument is reset during flight.

8. Check operation of turn-and-bank indicator by observing proper response of needle and ball when turns are made during taxiing.

9. Check rate-of-climb indicator needle at zero.

#### Note

If the needle does not indicate zero, tap the instrument panel. If it still indicates incorrectly, readjust it by use of the screw in the lower left corner of the instrument.

10. Check accuracy of the magnetic compass by comparing its reading to the published runway heading.

11. Check that clock is operating and is set to correct time.

12. Move carburetor heat control handle to HOT. Proper operation is verified by a resultant drop in manifold pressure as the mixture temperature increases. Return carburetor heat control handle to COLD.

13. Check instruments for readings within proper ranges.

14. Check operation of all radio equipment. Adjust tuning of required radio equipment as desired.

#### INSTRUMENT TAKE-OFF.

Preparation, power settings, and take-off and climb speeds are identical to those used in normal take-off. Since use of flaps reduces rate of climb, flaps should not be used for instrument take-offs.

1. When cleared for take-off, taxi to the center of the runway and align the airplane, as nearly as possible, straight down the centerline of the runway. Hold the airplane with the brakes. Set directional gyro to the published runway heading.

2. When ready, advance throttle to obtain 1000 to 1200 rpm. Release brakes and, as the airplane starts to roll, advance throttle smoothly to the sea-level stop.

3. Maintain directional control by reference to directional gyro. When elevator control becomes effective, raise the tail slightly and allow the airplane to leave the ground with the nose slightly lower than a three-point attitude as indicated on the gyro horizon.

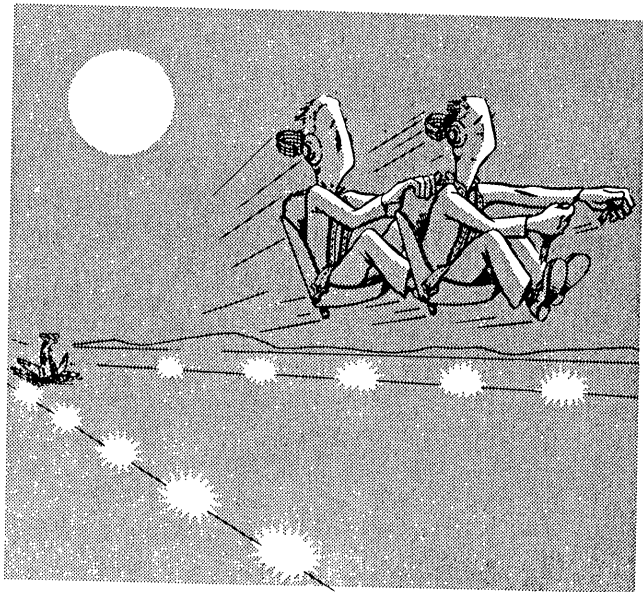

*Prior to take-off under instrument conditions, special attention should be given to gyro instruments and airplane trim. Any irregularity could have serious consequences.*

4. Hold this pitch attitude and, as the airplane breaks ground, hold the wings level by reference to the gyro horizon. Hold direction by reference to the directional gyro.

5. As soon as the altimeter and rate-of-climb indicator begin to register a climb, retract the landing gear.

6. Reduce the throttle and propeller control setting to give approximately 30 in. Hg manifold pressure and 2000 rpm only after climbing airspeed is reached.

#### INSTRUMENT CLIMB.

1. Establish a rate of climb to obtain approximately 500 feet per minute on the rate-of-climb indicator until normal climbing speed is reached; then trim airplane to maintain this airspeed.

2. Leave traffic and climb to assigned flight altitude in accordance with local air traffic regulations. Do not exceed a 30-degree bank during climbing turns.

#### INSTRUMENT CRUISING FLIGHT.

Since trim of the airplane will change rapidly when speed is increased or decreased, adjustment of the trim tabs will be necessary until speed is stabilized. Since no aileron trim facilities are provided, balance the airplane laterally by maintaining an even fuel level. While changing cruising airspeed, momentarily overpower or underpower (3 to 5 in. Hg) beyond the desired power setting for a quicker response. The recommended airspeeds, shown in the following chart, will provide a safe margin above stall and good controllability for practice instrument flight. Power settings shown in figure 9-1 will normally give standard airspeeds listed.

**Note**

If landing gear is extended, the power settings should be slightly higher.

**DESCENT.**

Normal descent procedures are followed.

**HOLDING.**

If holding is necessary for an extended period, fuel can be conserved by using a power setting of 1600 rpm and enough manifold pressure to maintain an airspeed of 100 mph IAS.

**INSTRUMENT APPROACHES.**

Radio range letdown and low visibility approaches are standard.

**GROUND CONTROLLED APPROACH.** Procedure for landing under instrument conditions by use of directions from ground controlled approach radar equipment after letdown on a radio range is as follows:

1. Establish contact with GCA over GCA pickup point.
2. Hold 110 mph IAS until final turn is completed, running through GCA prelanding cockpit check as instructed by GCA controller.
3. After completing turn to final approach and prior to intercepting the glide path, lower flaps 20 degrees.
4. As glide path is intercepted, reduce throttle setting to obtain 17 in. Hg manifold pressure and descend as directed by the GCA final controller.

**ICE AND RAIN.**

During a winter fog or rain, watch for icing on wings from propeller blast during engine run-up. Don't take off in sleet if you can avoid it, because it may freeze on the wings before you can gain altitude. If carburetor ice has formed during group operation, use carburetor heat to remove ice prior to take-off and as necessary during take-off.

**WARNING**

The carburetor is susceptible to icing and may ice up at any time under actual instrument flight conditions. Except in extreme cases, carburetor mixture temperatures of approximately 3°C will be sufficient to clear the carburetor or prevent icing.

Engine roughness and a slight drop in manifold pressure are indications of ice forming in the carburetor. If carburetor icing is indicated, carburetor heat should first be applied at a somewhat higher temperature than is normally used and then readjusted as necessary to prevent further icing. Fuel consumption will increase slightly with the application of carburetor heat. If icing is encountered during low rpm operation, increase the engine speed and manifold pressure and enrich the mixture.

**INSTRUMENT CRUISING FLIGHT**



| RECOMMENDED AIRSPEEDS                        | RPM  | APPROX MAN. PRESS. (In. Hg) | MIXTURE   |
|--|------|-----------------------------|---|
| Climb to cruising altitude — 110 mph IAS     | 2000 | 30                          | Mixture adjusted for smoothest operation above 3000 feet. |
| Slow cruise — 110 mph IAS                    | 1850 | 18                          |   |
| Normal cruise — 130 mph IAS                  | 1850 | 21                          |   |
| Fast cruise — 140 mph IAS                    | 1850 | 24                          |   |
| Climb — 500 fpm — 110 mph IAS                | 1850 | 25                          |   |
| Descent — 500 fpm — 110 mph IAS              | 1850 | 13                          |   |
| GCA airspeed — 20 degree flaps — 100 mph IAS | 2000 | 16-18                       | <b>RICH</b>   |

168-93-1339

Figure 9-1

If ice has accumulated on wings, make wide, shallow turns at a speed greater than normal, especially during the approach. Use flaps with care. Remember, stalling speed increases with ice. The only units that incorporate provisions to prevent icing are the pitot head and carburetor. Additional information concerning carburetor icing is given in Section VII.

**FLIGHT IN TURBULENCE AND THUNDERSTORMS.**

Since circumstances may force you at some time to enter a zone of severe turbulence, you should be familiar with the techniques recommended for flying this airplane under such circumstances. Power setting and pitch attitude are the keys to proper flight technique in turbulent air. The power setting and pitch attitude for the desired penetration airspeed should be established before entrance into the storm and, if maintained throughout the storm, should result in a constant airspeed regardless of any false indications by the airspeed indicator. Instruc-

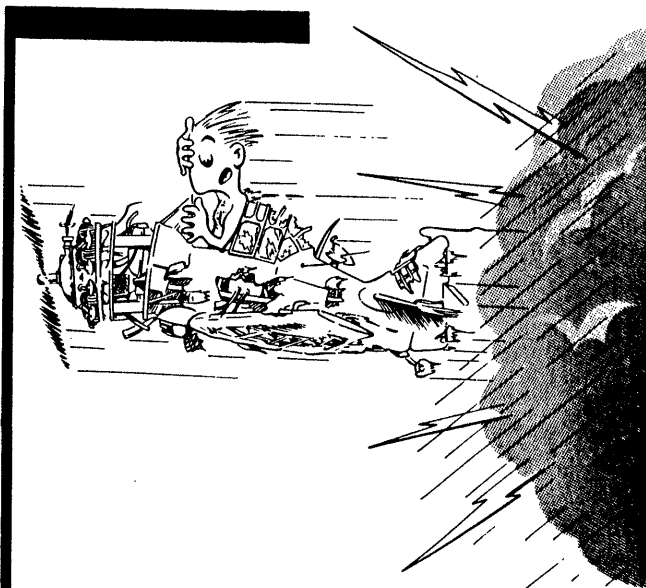

*A pilot, using modern equipment and possessing a combination of proper experience, common sense, and instrument flying proficiency, can safely fly thunderstorms. However, flight through a thunderstorm should be avoided if it is at all possible.*

tions for preparing to enter a storm and flying in it are given in the following paragraphs.

**BEFORE TAKE-OFF.** Perform the following checks before take-off when flight through a storm is anticipated:

1. Check Turbulent Air Penetration Speed chart (figure 9-2) for best penetration speed.
2. Make a thorough analysis of the general weather to determine thunderstorm areas, and prepare a flight plan that will avoid thunderstorm areas whenever possible.

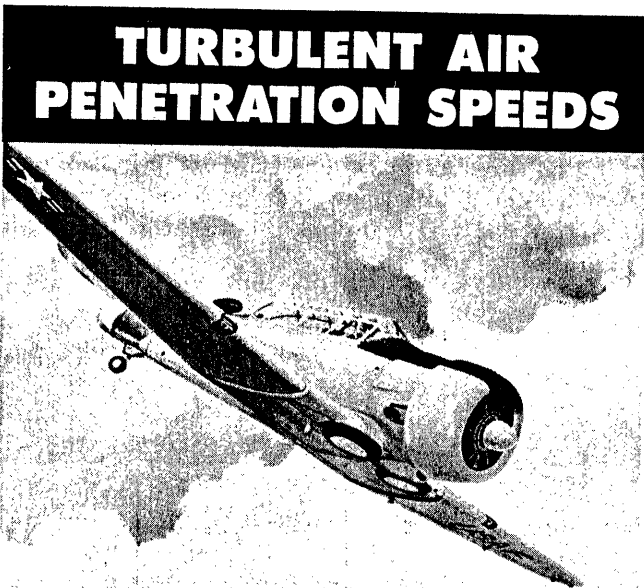

**TURBULENT AIR PENETRATION SPEEDS**

**INDICATED AIRSPEED — MPH**

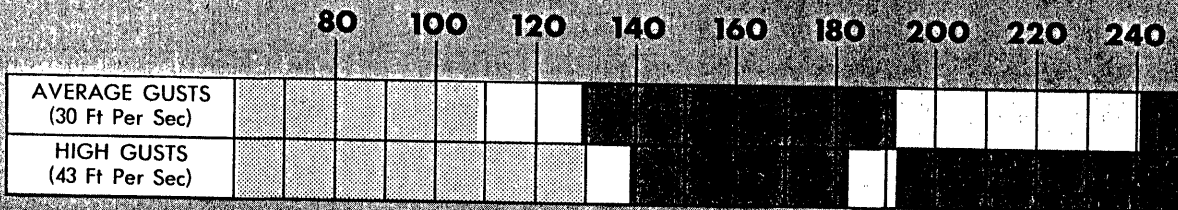

Safe Airspeed Zone  
 Cautionary Zone  
 Danger Zone — Stall  
 Danger Zone — Structural Failure

168-93-1271A

Figure 9-2



3. Be sure to check proper operation of all flight instruments, navigation equipment, pitot heater, carburetor air heater, and panel lights before attempting flight through thunderstorm areas.

**APPROACHING THE STORM.** It is imperative that you prepare the airplane prior to entering a zone of turbulent air. If the storm cannot be seen, its proximity can be detected by radio crash static. Prepare the airplane as follows:

1. Accurately fix position before actual entry into thunderstorm area.
2. Propeller control set to obtain 1900 rpm for gyroscopic stability.
3. Mixture control adjusted for smooth engine operation.
4. Pitot heater switch ON.
5. Carburetor air control adjusted as required.
6. Throttle adjusted as necessary to obtain desired penetration speed.
7. Check suction gage for proper reading and gyro instruments for correct settings.
8. Tighten safety belt. Lock shoulder harness.
9. Turn off any radio equipment rendered useless by static.
10. To minimize the blinding effect of lightning at night, turn cockpit lights full bright or use dark glasses, adjust seat low, and don't stare outside airplane.



When flying through turbulent air, do not lower gear and flaps, as they decrease the aerodynamic efficiency of the airplane.

**IN THE STORM.** While flying through the storm, observe the following precautions:

## COLD-WEATHER PROCEDURES

The success of low-temperature operation depends greatly on the preparation made previously during engine shutdown and post flight procedures as outlined in the following paragraphs. Icing conditions, however, are covered in the instructions for instrument flight.

### BEFORE ENTERING THE AIRPLANE.

1. Have "Y" drain and oil tank sump checked for free flow. If no oil flow is obtained, heat should be applied.

#### Note

If oil was not diluted when the engine was previously shut down, heating will be necessary at temperatures below 2°C (35°F). At temperatures below -18°C (0°F), heat should be applied to the engine and accessories. Below

1. Maintain, throughout the storm, the power setting and pitch attitude established before entering the storm. Hold these constant and your airspeed will be constant, regardless of the airspeed indicator.

2. Maintain attitude. Concentrate principally on holding a level attitude by reference to the gyro horizon.

3. Maintain original heading. Do not make any turns unless absolutely necessary.

4. Don't chase the airspeed indicator, since doing so will result in extreme airplane attitudes. If a sudden gust should be encountered while the airplane is in a nose-high attitude, a stall might easily result. Because of rapid changes in vertical gust velocity or rain clogging the pitot tube, the airspeed may momentarily fluctuate as much as 70 mph.

5. Use as little elevator control as possible to maintain your attitude in order to minimize the stresses imposed on the airplane.

6. The altimeter and rate-of-climb indicator may be unreliable in thunderstorms because of differential barometric pressure within the storm. A gain or loss of several thousand feet may be expected. Altitude must be allowed to vary to let the airplane ride out the storm. Make allowance for this condition in determining a minimum safe altitude.

#### Note

Normally, the least turbulent area in a thunderstorm will be at altitudes between 6000 and 8000 feet above the terrain. Altitudes between 10,000 and 20,000 feet are usually the most turbulent.

7. Maintain a constant power setting and pitch attitude unless airspeed falls off to 60 percent above power-on stalling speed, or unless airspeed increases to approximately 30 percent above maximum penetration airspeed.

-30°C (-22°F), it may be necessary to apply heat also to the battery, cockpits, master brake cylinder, and actuating cylinders.

2. Have moisture drained from all fuel tanks and fuel system sumps; if they are frozen, heat should be applied first. Check fuel and oil tank vent lines for free passage.

3. Check gear and shock struts free of dirt and ice.

4. Have protective covers removed from airplane and any snow or ice removed from surfaces, control hinges, propeller, pitot tube, fuel and oil vents, and crankcase breather outlet.

5. Check freedom of propeller periodically to determine engine stiffness. If propeller cannot be moved easily, continue preheat.



6. Have engine cover and ground heater removed.

**BEFORE STARTING ENGINE.**

1. Have external power source connected to conserve battery life for use during in-flight emergencies.
2. Have oil immersion heater removed.
3. Have propeller pulled through at least two revolutions.
4. Prime engine four to six strokes.

**Note**

Rapid priming action may be necessary to vaporize the fuel sufficiently.

**STARTING ENGINE.**

1. After engine starts, continue priming until engine is running smoothly.
2. If there is no indication of oil pressure after 30 seconds running, or if pressure drops after a few minutes of ground operation, stop engine and investigate.
3. Use carburetor heat to assist fuel vaporization.

**WARM-UP AND GROUND TESTS.**

1. Check all instruments for normal operation.
2. When oil temperature and pressure are normal, ad-

vance the throttle to 1400 rpm and pull propeller control to full DECREASE position until a drop of 200 rpm is obtained; then return control to full INCREASE position. Repeat procedure three times to ensure that hot oil is in propeller dome.

3. Operate wing flaps through at least one complete cycle.

4. Perform all ground tests requiring electrical power before disconnecting external power source.

**Note**

The battery cannot carry the electrical load imposed by ground operation of pitot heater and radios. Minimize load on the electrical system until the generator "cuts in."

5. Have external power source disconnected and turn battery-disconnect switch ON.

**TAXIING INSTRUCTIONS.**

Use only essential electrical equipment to preserve battery life while taxiing at low engine speeds. Avoid slushy and icy areas. Apply brakes cautiously to prevent skidding. Avoid taxiing in deep snow, as steering and taxiing are extremely difficult and frozen brakes are likely to result.

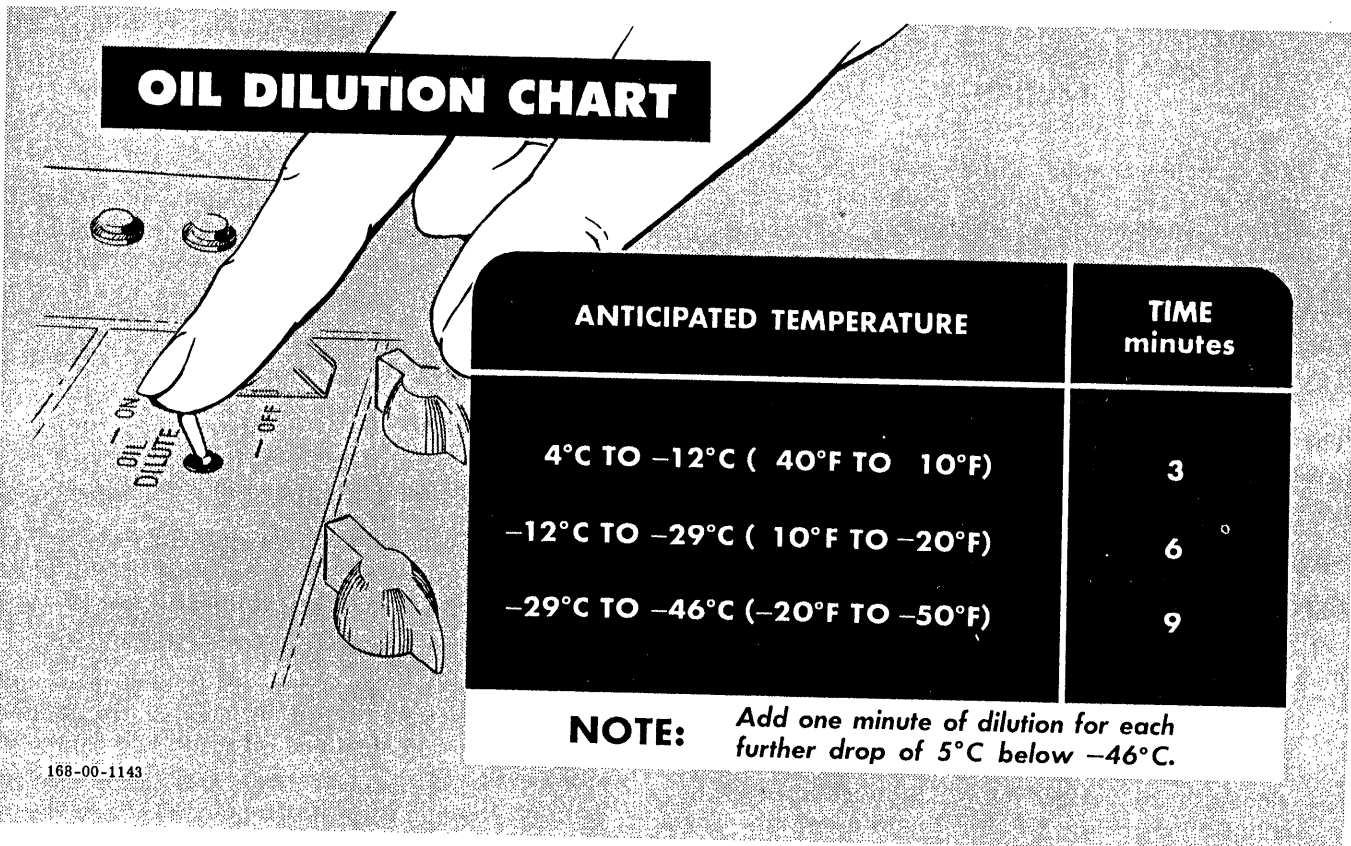

168-00-1143

Figure 9-3



#### BEFORE TAKE-OFF.

1. Check controls very carefully for free and proper movement.
2. Hold brakes and run up engine to 2000 rpm until spark plugs have burned clean and engine is operating smoothly. Then check magnetos.
3. Apply carburetor heat as necessary to maintain carburetor mixture temperature within limits during take-off.
4. Place pitot heat switch ON just before rolling into position for take-off.

#### TAKE-OFF.

At start of take-off run, advance throttle rapidly to take-off setting and check that full power is available. If full power is not obtained, immediately discontinue take-off. Since cold, dry air has a greater density, engine power output and airplane lift are increased.

#### AFTER TAKE-OFF.

After take-off from a wet snow- or slush-covered field, operate the landing gear and flaps through several complete cycles to prevent their freezing in the retracted position. Expect considerably slower operation of the landing gear and flaps in cold weather.

#### CLIMB.

Adjust carburetor air control as necessary to prevent carburetor icing.

#### DURING FLIGHT.

1. At low outside air temperatures, especially during low-power cruising operation, the fuel-air mixture ratio may be too cold for proper vaporization and fuel economy. Use carburetor heat as necessary to obtain smooth engine operation and to eliminate plug fouling.
2. Operate propeller control every 30 minutes, obtaining approximately a 300 rpm increase and decrease from cruising position; then return to cruise rpm. Otherwise, oil may congeal in propeller hub.
3. Adjust cockpit heat as necessary.

#### DESCENT.

1. Use power during the descent to prevent engine from being cooled too rapidly.
2. Increase carburetor heat as necessary.
3. Mixture control RICH.

#### APPROACH.

1. Make a longer, lower approach than normal so that

some power is needed to reach the runway. Use carburetor heat.

2. Pump brake pedals several times to be sure adequate braking is available.

#### LANDING.

Use normal landing procedure.

#### STOPPING ENGINE.

**OIL DILUTION.** Before shutdown, the engine oil should be diluted unless the entire oil system is to be drained. If it is necessary to service the oil tank, shut down the engine and have it serviced before diluting. Then restart the engine and dilute as follows:

1. Run engine at 1000 rpm.
2. During dilution, maintain oil temperature from 5°C to 50°C and oil pressure above 15 psi. Reset throttle, if necessary, to maintain these conditions. If oil temperature is above 50°C, shut down engine and allow oil to cool below 40°C; then restart and dilute.
3. Hold oil dilution switch ON, as required by lowest expected temperature, for time indicated in figure 9-3.
4. Dilute the oil in the propeller by operating the propeller control during the latter part of the dilution time interval. Advance throttle to 1400 rpm and move propeller control back until a decrease of approximately 200 rpm is obtained; then return control to full INCREASE. Repeat operation three times.

#### BEFORE LEAVING THE AIRPLANE.

1. Release the brakes.
2. Check dirt and ice removed from shock struts.
3. Inspect oil and fuel tanks and engine breather to verify absence of any accumulated ice.
4. Leave canopy partially open to prevent cracking of transparent areas due to differential contraction. Air circulation also retards formation of frost.
5. Have protective covers installed.
6. Have oil tank sump, "Y" drain, and fuel sumps drained of condensation approximately 30 minutes after stopping the engine. If the airplane is to be idle for several days, the oil should be drained.
7. If specific gravity of battery is less than 1.250, have battery removed for service. If layover of several days is anticipated, or if temperature is below -29°C (-20°F) and airplane will be idle more than 4 hours, have the battery removed.

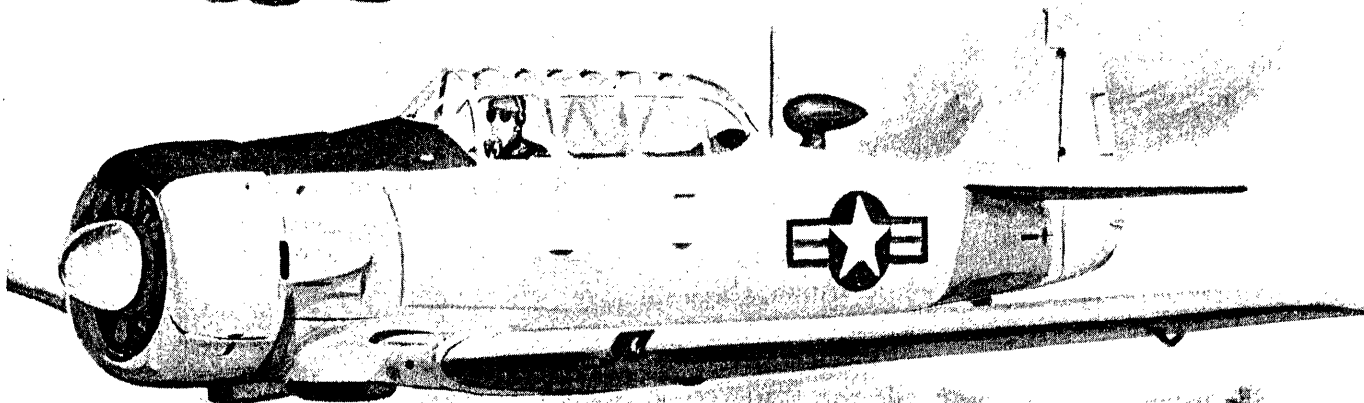
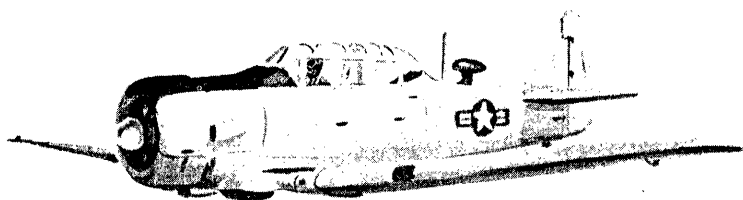
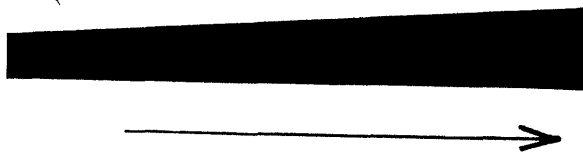

# Operating Data Charts



## APPENDIX I

### INTRODUCTION.

There are two ways to perform a mission. The *correct* method can be determined from the information presented in the charts, on the following pages. If a pilot chooses to ignore the charts he can fly any mission confident that the airplane is capable of greater performance than he is capable of obtaining from it. These charts, which are easy to interpret, enable you to fly a greater distance at better cruising speed and arrive at your destination with more reserve fuel. A description of each chart and a sample problem to illustrate a typical training mission are also included.

### AIRSPEED INSTALLATION CORRECTION.

An Airspeed Installation Correction table (figure A-1) is provided for computing calibrated airspeed (CAS) from indicated airspeed (IAS). Indicated airspeed is the airspeed indicator reading. Calibrated airspeed is indicated airspeed corrected for installation error. Equivalent airspeed (EAS) is calibrated airspeed corrected for compressibility error. (Within the airspeed range of the airplane, the compressibility error is negligible, and CAS may be considered as EAS.) True airspeed is equivalent airspeed corrected for atmospheric density.

### EXAMPLE—USE OF CORRECTION TABLE.

An airplane is flying at 5000 feet pressure altitude, free air temperature is  $+16^{\circ}\text{C}$ , and airspeed indicator reading is 130 mph. What is the true airspeed?

|  |         |
|--|---------|
| Airspeed indicator reading.....        | 130 mph |
| Correction for installation error..... | +1 mph  |
| Calibrated airspeed .....              | 131 mph |

Use this value of CAS with a Type D-4 or Type G-1 airspeed computer, or a Type AN5835-1 dead-reckoning computer, to determine the true airspeed of 144 mph.

### Note

When the dead-reckoning computer is used, CAS usually must be corrected for compressibility error; however, since this correction is not considered on this airplane, CAS may be considered as EAS.

### AIR TEMPERATURE CORRECTION.

Air temperature correction for compressibility is negligible (less than  $5^{\circ}\text{C}$  in level-flight cruising) and is not considered. Indicated free air temperature may be considered as true free air temperature.

### ALTIMETER INSTALLATION CORRECTION.

An Altimeter Installation Correction table (figure A-2) is provided for obtaining true pressure altitude from the altimeter reading.

### TAKE-OFF DISTANCES.

A Take-off Distances chart (figure A-4) gives take-off ground run distances and total distances to clear a 50-foot obstacle, tabulated for several different altitudes and temperatures on a hard-surface runway. Distances given are for standard flaps-up take-offs. For a minimum-run take-off, refer to Section II.

## AIRSPPEED INSTALLATION CORRECTION TABLE

APPLY CORRECTION TO INDICATED AIRSPEED  
TO OBTAIN CALIBRATED AIRSPEED

| GEAR AND FLAPS UP – CANOPY CLOSED |                  | GEAR AND FLAPS DOWN – CANOPY OPEN |                  |
|-----------------------------------|------------------|-----------------------------------|------------------|
| IAS (MPH)                         | CORRECTION (MPH) | IAS (MPH)                         | CORRECTION (MPH) |
| 80                                | 0                | 60                                | 0                |
| 100                               | 1                | 70                                | 0                |
| 120                               | 2.5              | 80                                | 0                |
| 140                               | 4.0              | 90                                | 0.5              |
| 160                               | 5.5              | 100                               | 1.0              |
| 180                               | 7.0              | 110                               | 2.0              |
| 200                               | 8.5              | 120                               | 2.5              |
| 220                               | 10.0             |                                   |                  |
| 240                               | 11.0             |                                   |                  |

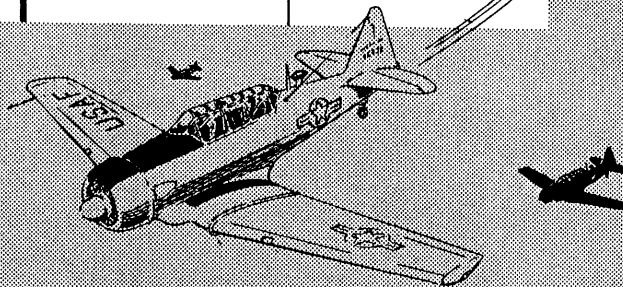

168-93-855A

Figure A-1

### NORMAL POWER CLIMB.

Best climb speed, fuel consumption, time to climb, and rate of climb (all at Maximum Continuous Power) can be determined from the Normal Power Climb chart (figure A-5). A fuel allowance for warm-up, taxi, and take-off is listed in the column labeled "SEA LEVEL." Fuel requirements listed at other altitudes include this allowance plus the fuel required to climb from sea level. Fuel required for an in-flight climb from one altitude to another is the difference between the tabulated fuel required to climb to each altitude from sea level.

### LANDING DISTANCES.

The Landing Distances chart (figure A-6) shows the distances required for ground roll and for landing over a 50-foot obstacle. Distances for landings on a hard-surface runway are furnished for several altitudes and gross weights. Best speeds are shown for both power-on and power-off approach. Distances given are airplane requirements under normal service conditions with no wind and with flaps full down.

### MAXIMUM ENDURANCE.

Airspeeds, power settings, and fuel flow rates for maximum endurance flight are shown in the Maximum Endurance chart (figure A-7) for several gross weights and altitudes. The Maximum Endurance chart giving

the power settings and fuel flows for maximum *time* in the air should not be confused with the "MAXIMUM AIR RANGE" section of the Flight Operation Instruction Chart in which the power settings and fuel flows are for maximum *distance*, not maximum *time*.

### COMBAT ALLOWANCE.

The Combat Allowance chart (figure A-8) shows the variation with altitude in manifold pressure and fuel flow at Take-off Power (Military Power).

### FLIGHT OPERATION INSTRUCTION CHART.

To assist in selecting the engine operating conditions required for obtaining various ranges, a Flight Operation Instruction Chart (figure A-9) is provided. The chart is divided into five main columns. Data listed under Column I is for emergency high-speed cruising at Maximum Continuous Power. Operating conditions in Columns II, III, IV, and V give progressively greater ranges at lower cruising speeds. Ranges shown in any column for a given fuel quantity can be obtained at various altitudes by using the power settings listed in the lower half of the chart in the same column. The speeds quoted on the chart are those obtained with gross weight equal to the high limit of the chart weight band. No allowances are made for wind, navigational error, simulated combat, formation flights, etc; therefore, such allowances must be made as required.

**USE OF CHART.**

Enter the chart at a fuel quantity equal to, or less than, the total amount in the airplane minus all allowances. (Ranges listed for each fuel quantity are based on using the entire quantity in level flight, cruising at the recommended operation conditions.) Fuel allowance for warm-up, taxi, take-off, and climb is obtained from the Normal Power Climb chart (figure A-5). Other allowances based on the type of mission, terrain over which the flight is to be made, and weather conditions are dictated by local policy. If your flight plan calls for a continuous flight at reasonably constant cruising power, compute the fuel required and flight time as a single-section flight. Otherwise, the flight must be broken up into sections and each leg of the flight planned separately. The flight plan may be changed at any time en route, and the chart will show the balance of range available at various cruising powers and altitudes if the instructions printed at the top of the chart are followed.

**SAMPLE PROBLEM—TRAINING MISSION.**

A triangular cross-country training mission is to be flown according to the flight plan illustrated in figure A-3. After take-off, climb to 2500 feet altitude and cross the air base. Fly the first leg of 150 miles at 2500 feet. Fly the second leg of 175 miles at 5000 feet altitude to avoid mountainous terrain. Fly the third leg of 175 miles at 10,000 feet back to the home station. Write down the conditions of the problem.

|   |                   |
|---|-------------------|
| Required range .....                                      | 500 statute miles |
| Weather .....   | CAVU              |
| Airplane basic weight.....                                | 4367 pounds       |
| (includes trapped fuel, oil, and miscellaneous equipment) |                   |
| Crew weight (2).....                                      | 400 pounds        |
| Oil (10.2 gallons).....                                   | 76 pounds         |
| Maximum fuel (138 gallons).....                           | 828 pounds        |
| Total gross weight.....                                   | 5671 pounds       |

Now that the conditions of the flight are determined, it is necessary to establish a flight plan. The chart gives only cruise ranges under no-wind conditions and does not include any reserve, so it is necessary to first compute all allowances required to cover warm-up, take-off, climb, and reserve for unexpected difficulties. Since Maximum Continuous Power and Take-off Power are not used during flight on this mission, no additional fuel allowance for these power settings is considered.

**DETERMINATION OF FUEL ALLOWANCES.** Determine the fuel available for flight planning by deducting the necessary fuel allowances from the actual fuel aboard as follows:

|   |            |
|---|------------|
| General reserve for unexpected difficulties ..... | 24 gallons |
|---|------------|

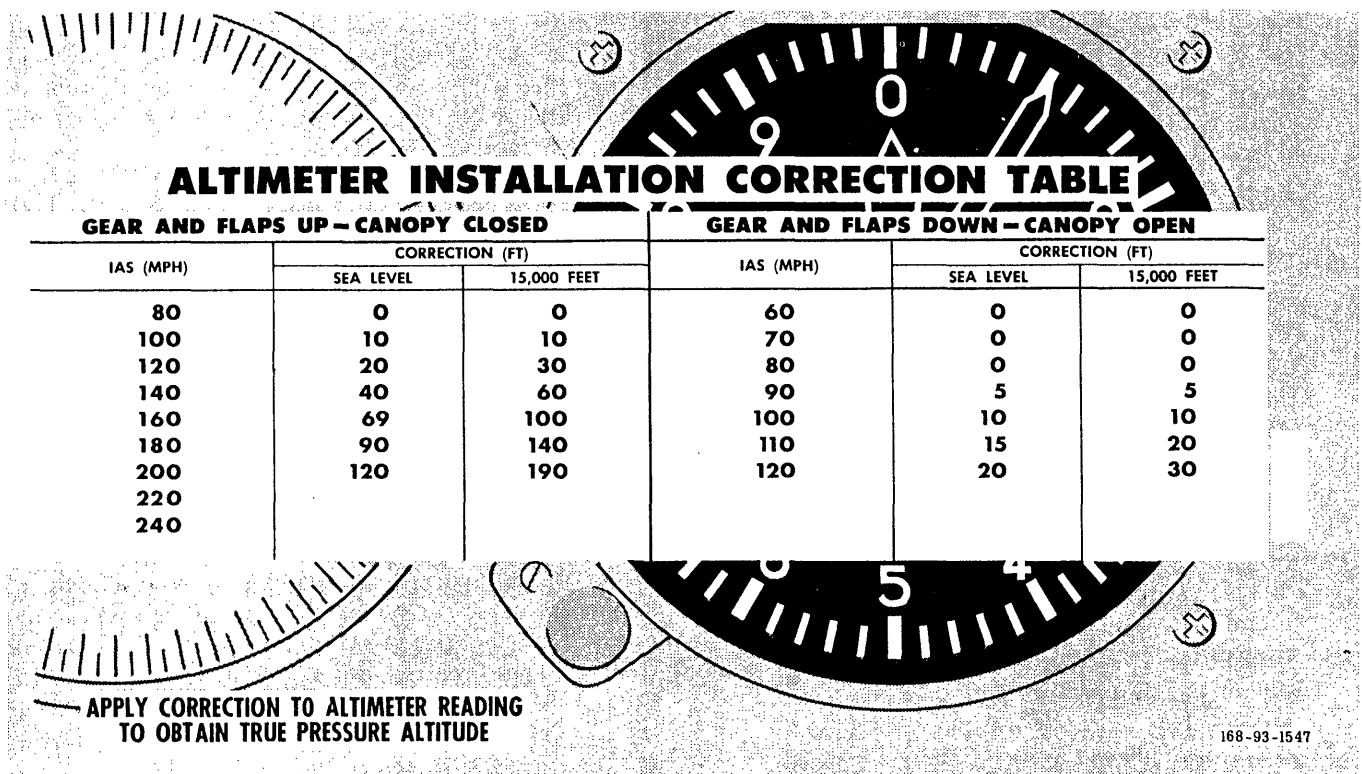
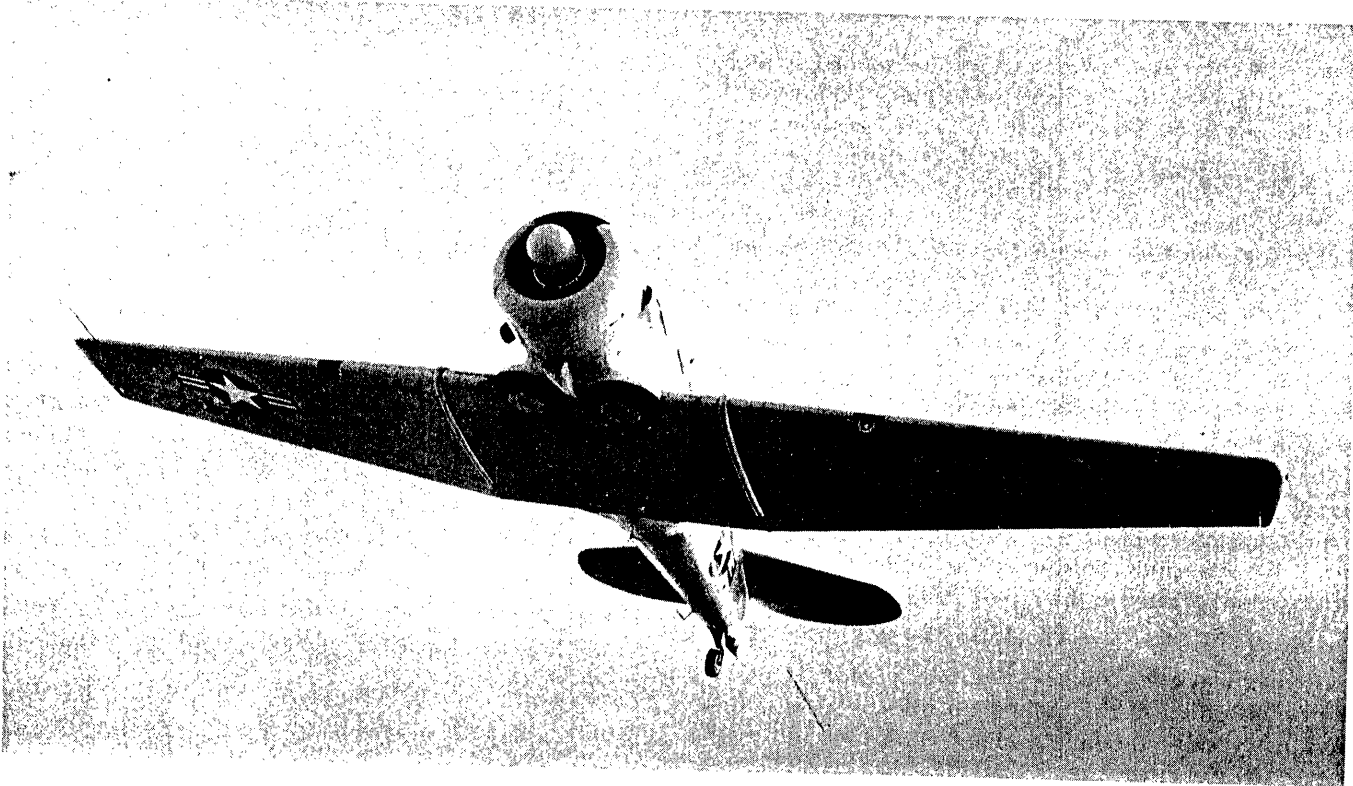

Figure A-2



Note in Column V of figure A-9 that at 10,000 feet 24 gallons of fuel represents one hour's flying time. A one-hour fuel reserve is considered sufficient for this mission.

Take-off and climb from sea level to 2500 feet.....11 gallons

The Normal Power Climb chart (figure A-5) shows by interpolation that 11 gallons is required for warm-up, take-off, and climb from sea level to 2500 feet.

Climb from 2500 feet to 5000 feet.....2 gallons

The Normal Power Climb chart (figure A-5) shows by interpolation that 2 gallons is required to climb from 2500 feet to 5000 feet. A distance of 3 miles is covered during the climb.

Climb from 5000 feet to 10,000 feet.....5 gallons

The Climb chart shows that 5 gallons is required to climb from 5000 feet to 10,000 feet (18 gallons minus 13 gallons). A distance of 9 miles is covered during the climb (16 miles minus 7 miles).

Collecting all the required fuel allowances:

General reserve for unexpected difficulties .....24 gallons

Take-off and climb from sea level to 2500 feet.....11 gallons

Climb from 2500 feet to 5000 feet..... 2 gallons

Climb from 5000 feet to 10,000 feet.. 5 gallons

Total fuel allowance.....42 gallons

**DETERMINATION OF FUEL REQUIRED FOR CRUISING.** Because of the foregoing fuel allowances, the actual fuel available for cruising is 96 gallons (138 gallons minus 42 gallons). In calculating climbing allowance, 12 miles of range (3 miles climbing from 2500 feet to 5000 feet, and 9 miles climbing from 5000 feet to 10,000 feet) was taken care of, so the total range for normal cruising is 500 miles minus 12 miles, or 488 statute miles. Assuming that the instructions in Column III of the Flight Operation Instruction Chart will be followed for all cruising conditions, the fuel required for 488 miles of cruise is, by interpolation, 85 gallons, which is 11 gallons less than the fuel available. This margin may be considered as an added safety feature, or the mission may be replanned around slightly higher power settings.

**SAMPLE PROBLEM—ALTERNATE FLIGHT PLAN.**

Should an emergency arise during flight, an alternate flight plan would have to be used. Suppose that arrival over the home field at the completion of the training mission is made after dark, and, because of a malfunction of field lighting facilities, a landing cannot be made. An alternate air base 70 miles away must be used. Suppose, because of circumnavigation of weather on the training mission, the 24-gallon reserve allowed for contingencies has been reduced to 14 gallons. Reference to Column V of the Flight Operation Instruction Chart (figure A-9) shows that 20 gallons is required to travel 140 statute miles; therefore 10 gallons is required to fly the 70 statute miles to the alternate field, assuming a no-wind condition. The remaining 4 gallons (14 minus



10 gallons) will permit a go-around procedure or may be used if it is necessary to hold over the alternate field prior to entry into the traffic pattern. The remaining 4 gallons constitutes a 14-minute time limit for holding at 5000 feet. Reference to the Maximum Endurance

chart (figure A-7) for 5800 pounds shows 18 gallons per hour used for maximum endurance at 10,000 feet. A descent to 5000 feet will give 17 gallons per hour; 4 gallons divided by 17 gallons per hour is .24 hours or 14 minutes.

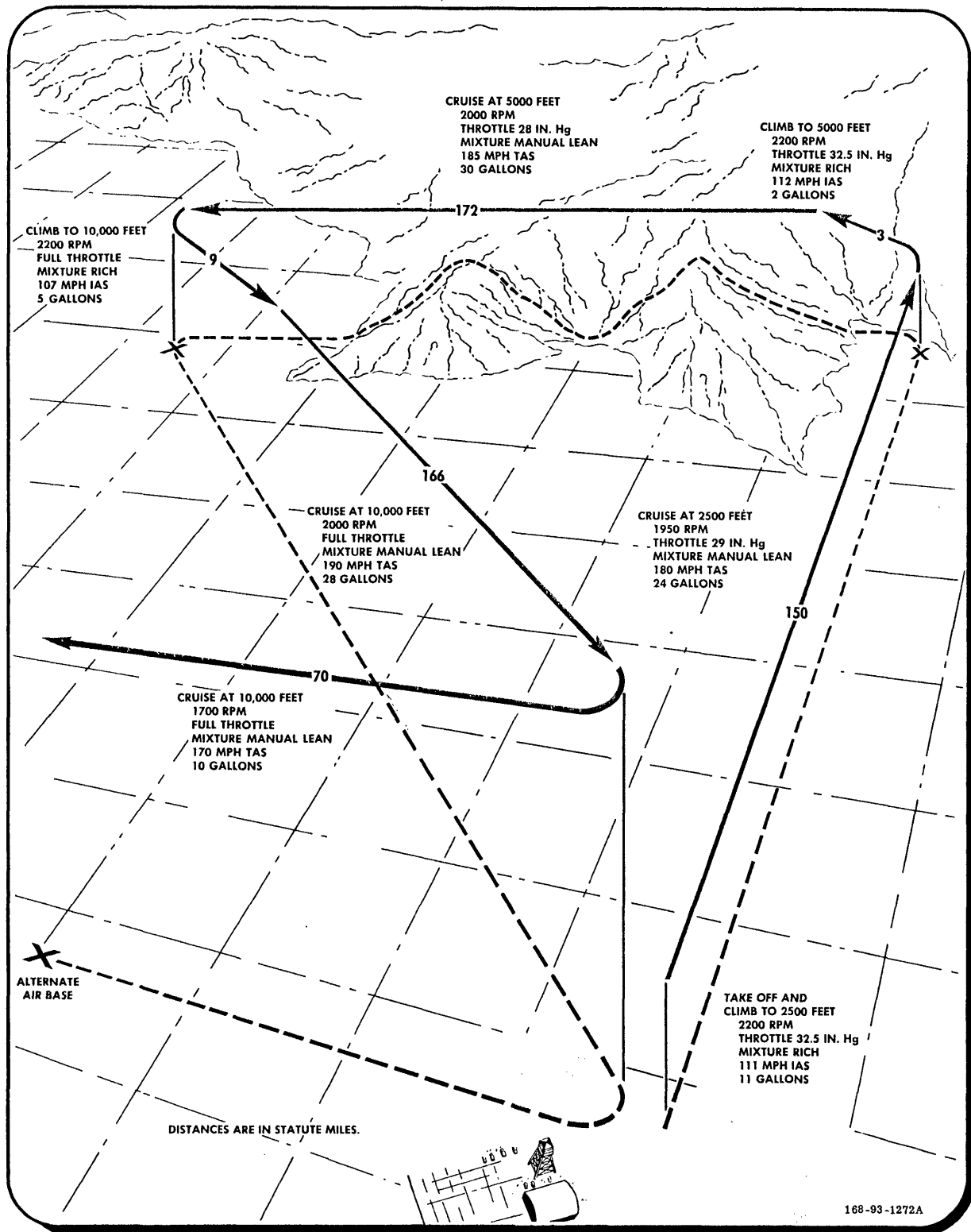

Figure A-3. Sample Problem—Training Mission

**TAKE-OFF DISTANCES**  
(FEET)  
**HARD-SURFACE RUNWAY**

ENGINE (S): (1) R-1340-AN-1

MODEL: T-6G

| CONFIGURATION AND GROSS WEIGHT | PRESSURE ALTITUDE | -5 DEGREES CENTIGRADE |                      |              |                      | +15 DEGREES CENTIGRADE |                      |              |                      | +35 DEGREES CENTIGRADE |                      |              |                      | +55 DEGREES CENTIGRADE |                      |              |                      |
|--------------------------------|-------------------|-----------------------|----------------------|--------------|----------------------|------------------------|----------------------|--------------|----------------------|------------------------|----------------------|--------------|----------------------|------------------------|----------------------|--------------|----------------------|
|                                |                   | ZERO WIND             |                      | 30-KNOT WIND |                      | ZERO WIND              |                      | 30-KNOT WIND |                      | ZERO WIND              |                      | 30-KNOT WIND |                      | ZERO WIND              |                      | 30-KNOT WIND |                      |
|                                |                   | GROUND RUN            | TO CLEAR 50 FT OBST. | GROUND RUN   | TO CLEAR 50 FT OBST. | GROUND RUN             | TO CLEAR 50 FT OBST. | GROUND RUN   | TO CLEAR 50 FT OBST. | GROUND RUN             | TO CLEAR 50 FT OBST. | GROUND RUN   | TO CLEAR 50 FT OBST. | GROUND RUN             | TO CLEAR 50 FT OBST. | GROUND RUN   | TO CLEAR 50 FT OBST. |
| 6000 LB                        | SL                | 1000                  | 1650                 | 350          | 750                  | 1100                   | 1850                 | 400          | 850                  | 1250                   | 2000                 | 500          | 950                  | 1400                   | 2200                 | 550          | 1050                 |
|                                | 1000              | 1000                  | 1700                 | 350          | 750                  | 1150                   | 1900                 | 450          | 850                  | 1300                   | 2050                 | 500          | 950                  | 1400                   | 2250                 | 600          | 1100                 |
|                                | 2000              | 1050                  | 1750                 | 400          | 800                  | 1200                   | 1950                 | 450          | 900                  | 1350                   | 2150                 | 550          | 1050                 | 1500                   | 2400                 | 650          | 1150                 |
|                                | 3000              | 1150                  | 1900                 | 450          | 850                  | 1300                   | 2100                 | 500          | 1000                 | 1450                   | 2250                 | 600          | 1100                 | 1600                   | 2500                 | 700          | 1250                 |
|                                | 4000              | 1250                  | 2000                 | 500          | 950                  | 1400                   | 2200                 | 550          | 1050                 | 1550                   | 2400                 | 650          | 1200                 | 1750                   | 2700                 | 750          | 1350                 |
| CLEAN                          | 5000              | 1350                  | 2150                 | 550          | 1000                 | 1500                   | 2400                 | 650          | 1150                 | 1700                   | 2600                 | 750          | 1300                 | 1900                   | 2900                 | 850          | 1500                 |
|                                | SL                | 900                   | 1550                 | 300          | 650                  | 1050                   | 1700                 | 350          | 750                  | 1150                   | 1900                 | 450          | 850                  | 1250                   | 2050                 | 500          | 950                  |
|                                | 1000              | 950                   | 1600                 | 300          | 700                  | 1050                   | 1750                 | 400          | 800                  | 1200                   | 1950                 | 450          | 900                  | 1350                   | 2100                 | 550          | 1000                 |
|                                | 2000              | 1000                  | 1650                 | 350          | 750                  | 1100                   | 1850                 | 400          | 850                  | 1250                   | 2050                 | 500          | 950                  | 1400                   | 2200                 | 600          | 1100                 |
|                                | 3000              | 1050                  | 1750                 | 400          | 800                  | 1200                   | 1950                 | 450          | 900                  | 1350                   | 2150                 | 550          | 1050                 | 1500                   | 2350                 | 650          | 1150                 |
| 5500 LB                        | 4000              | 1150                  | 1900                 | 450          | 900                  | 1300                   | 2100                 | 500          | 1000                 | 1450                   | 2300                 | 600          | 1100                 | 1600                   | 2500                 | 700          | 1250                 |
|                                | 5000              | 1250                  | 2050                 | 500          | 950                  | 1400                   | 2250                 | 600          | 1100                 | 1600                   | 2500                 | 650          | 1200                 | 1800                   | 2750                 | 800          | 1400                 |
|                                | SL                | 800                   | 1400                 | 250          | 600                  | 900                    | 1550                 | 300          | 700                  | 1050                   | 1700                 | 400          | 800                  | 1150                   | 1850                 | 450          | 850                  |
|                                | 1000              | 850                   | 1450                 | 300          | 650                  | 950                    | 1600                 | 350          | 700                  | 1050                   | 1750                 | 400          | 800                  | 1150                   | 1900                 | 450          | 900                  |
|                                | 2000              | 900                   | 1500                 | 300          | 650                  | 1000                   | 1650                 | 350          | 750                  | 1100                   | 1850                 | 400          | 850                  | 1250                   | 2000                 | 500          | 950                  |
| CLEAN                          | 3000              | 950                   | 1600                 | 350          | 700                  | 1050                   | 1750                 | 400          | 800                  | 1200                   | 1950                 | 450          | 900                  | 1300                   | 2100                 | 550          | 1000                 |
|                                | 4000              | 1000                  | 1700                 | 400          | 800                  | 1150                   | 1900                 | 450          | 900                  | 1300                   | 2050                 | 500          | 1000                 | 1400                   | 2250                 | 600          | 1100                 |
|                                | 5000              | 1100                  | 1850                 | 400          | 850                  | 1250                   | 2000                 | 500          | 950                  | 1400                   | 2250                 | 600          | 1100                 | 1550                   | 2450                 | 650          | 1200                 |
|                                | SL                | 650                   | 1200                 | 200          | 500                  | 750                    | 1300                 | 250          | 550                  | 800                    | 1450                 | 300          | 650                  | 900                    | 1550                 | 350          | 700                  |
|                                | 1000              | 700                   | 1250                 | 200          | 500                  | 750                    | 1350                 | 250          | 600                  | 850                    | 1500                 | 300          | 650                  | 950                    | 1600                 | 350          | 750                  |
| 5000 LB                        | 2000              | 700                   | 1300                 | 250          | 550                  | 800                    | 1400                 | 300          | 600                  | 900                    | 1550                 | 350          | 700                  | 1000                   | 1650                 | 350          | 800                  |
|                                | 3000              | 750                   | 1350                 | 250          | 600                  | 850                    | 1500                 | 300          | 650                  | 950                    | 1650                 | 350          | 750                  | 1050                   | 1750                 | 400          | 850                  |
|                                | 4000              | 800                   | 1450                 | 300          | 650                  | 900                    | 1600                 | 350          | 700                  | 1050                   | 1750                 | 400          | 800                  | 1150                   | 1900                 | 450          | 900                  |
|                                | 5000              | 900                   | 1550                 | 300          | 700                  | 1000                   | 1700                 | 400          | 750                  | 1150                   | 1850                 | 450          | 850                  | 1250                   | 2050                 | 500          | 1000                 |
|                                | SL                | 800                   | 1400                 | 250          | 600                  | 900                    | 1550                 | 300          | 700                  | 1050                   | 1700                 | 400          | 800                  | 1150                   | 1850                 | 450          | 900                  |

REMARKS: 1. Take-off distances are airplane requirements under normal service conditions.  
 2. Flaps up (0 degrees).  
 3. RPM = 2250.  
 4. MP = 36.0 in. Hg.

DATA AS OF 4-17-52  
 BASED ON FLIGHT TEST

FUEL GRADE: MIL-F-5572, 91/96  
 FUEL DENSITY: 6.0 LB/GAL

168-93-1252B

Figure A-4. Take-off Distances

| WADC<br>Form 2411<br>(11 Jun 51)  | <h2 style="margin: 0;">NORMAL POWER CLIMB CHART</h2> <h3 style="margin: 0;">STANDARD DAY</h3> |      |      |                |              |   |              |   |                |      |          |                           |
|---|---|------|------|----------------|--------------|---|--------------|---|----------------|------|----------|---------------------------|
| MODEL: T-6G   |   |      |      |                |              | ENGINE(S): (1) R-1340-AN-1                                |              |   |                |      |          |                           |
| CONFIGURATION: CLEAN  |   |      |      |                |              | CONFIGURATION: CLEAN                                      |              |   |                |      |          |                           |
| GROSS WEIGHT: 6000 POUNDS   |   |      |      |                |              | GROSS WEIGHT: 5800 POUNDS                                 |              |   |                |      |          |                           |
| APPROXIMATE   |   |      |      | MP<br>(IN. Hg) | CAS<br>(MPH) | PRESSURE<br>ALTITUDE<br>(FEET)                            | CAS<br>(MPH) | MP<br>(IN. Hg)  | APPROXIMATE    |      |          |                           |
| RATE OF<br>CLIMB<br>(FPM)   | FROM SEA LEVEL  |      |      |                |              |   |              |   | FROM SEA LEVEL |      |          | RATE OF<br>CLIMB<br>(FPM) |
|   | DISTANCE  | TIME | FUEL |                |              |   |              |   | FUEL           | TIME | DISTANCE |                           |
| 1000  | 0   | 0    | 9    | 32.5           | 112          | SEA LEVEL   | 112          | 32.5  | 9              | 0    | 0        | 1050                      |
| 1000  | 8   | 5    | 14   | 32.5           | 113          | 5,000   | 113          | 32.5  | 14             | 5    | 9        | 1050                      |
| 650   | 19  | 11   | 19   | F. T.          | 108          | 10,000  | 108          | F. T.   | 19             | 10   | 21       | 700                       |
| 350   | 38  | 21   | 26   | F. T.          | 101          | 15,000  | 101          | F. T.   | 24             | 20   | 40       | 400                       |
|   |   |      |      |                |              | 20,000  | 94           | F. T.   | 37             | 45   | 95       | 60                        |
|   |   |      |      |                |              | 25,000  |              |   |                |      |          |                           |
|   |   |      |      |                |              | 30,000  |              |   |                |      |          |                           |
|   |   |      |      |                |              | 35,000  |              |   |                |      |          |                           |
|   |   |      |      |                |              | 40,000  |              |   |                |      |          |                           |
|   |   |      |      |                |              | 45,000  |              |   |                |      |          |                           |
| CONFIGURATION: CLEAN  |   |      |      |                |              | CONFIGURATION: CLEAN                                      |              |   |                |      |          |                           |
| GROSS WEIGHT: 5500 POUNDS   |   |      |      |                |              | GROSS WEIGHT: 5000 POUNDS                                 |              |   |                |      |          |                           |
| APPROXIMATE   |   |      |      | MP<br>(IN. Hg) | CAS<br>(MPH) | PRESSURE<br>ALTITUDE<br>(FEET)                            | CAS<br>(MPH) | MP<br>(IN. Hg)  | APPROXIMATE    |      |          |                           |
| RATE OF<br>CLIMB<br>(FPM)   | FROM SEA LEVEL  |      |      |                |              |   |              |   | FROM SEA LEVEL |      |          | RATE OF<br>CLIMB<br>(FPM) |
|   | DISTANCE  | TIME | FUEL |                |              |   |              |   | FUEL           | TIME | DISTANCE |                           |
| 1150  | 0   | 0    | 9    | 32.5           | 112          | SEA LEVEL   | 112          | 32.5  | 9              | 0    | 0        | 1350                      |
| 1150  | 7   | 5    | 13   | 32.5           | 113          | 5,000   | 113          | 32.5  | 13             | 4    | 6        | 1350                      |
| 800   | 16  | 9    | 18   | F. T.          | 108          | 10,000  | 108          | F. T.   | 16             | 8    | 14       | 1000                      |
| 500   | 31  | 17   | 23   | F. T.          | 101          | 15,000  | 101          | F. T.   | 20             | 14   | 25       | 650                       |
| 150   | 62  | 35   | 31   | F. T.          | 94           | 20,000  | 94           | F. T.   | 26             | 25   | 45       | 300                       |
|   |   |      |      |                |              | 25,000  |              |   |                |      |          |                           |
|   |   |      |      |                |              | 30,000  |              |   |                |      |          |                           |
|   |   |      |      |                |              | 35,000  |              |   |                |      |          |                           |
|   |   |      |      |                |              | 40,000  |              |   |                |      |          |                           |
|   |   |      |      |                |              | 45,000  |              |   |                |      |          |                           |
| REMARKS:<br>1. Warm-up, taxi, and take-off: 9 gallons.<br>2. Recommended climb power: 2200 rpm, rich mixture. |   |      |      |                |              |   |              | LEGEND<br>RATE OF CLIMB - FEET PER MINUTE<br>DISTANCE - STATUTE MILES<br>TIME - MINUTES<br>FUEL - US. GALLONS<br>MP - MANIFOLD PRESSURE<br>CAS - CALIBRATED AIRSPEED<br>F. T. - FULL THROTTLE |                |      |          |                           |
| DATA AS OF 4-17-52<br>BASED ON FLIGHT TEST  |   |      |      |                |              | FUEL GRADE: MIL-F-5572, 91/96<br>FUEL DENSITY: 6.0 LB/GAL |              |   |                |      |          |                           |
| 168-93-1253B  |   |      |      |                |              |   |              |   |                |      |          |                           |

Figure A-5. Normal Power Climb

| WADC<br>Form 241Q<br>(11 Jun 51)  |                       | <b>LANDING DISTANCES</b><br>(FEET)<br><b>STANDARD DAY</b> |                      |                      |             |   |             |  |             |                      |  |
|---|-----------------------|---|----------------------|----------------------|-------------|---|-------------|--|-------------|----------------------|--|
| MODEL: T-6G   |                       | ENGINE(S): (1) R-1340-AN-1                                |                      |                      |             |   |             |  |             |                      |  |
| GROSS WEIGHT (LB)   | BEST CAS FOR APPROACH |   | HARD-SURFACE-NO WIND |                      |             |   |             |  |             |                      |  |
|   | POWER ON (3)          | POWER OFF   | AT SEA LEVEL         |                      | AT 2000 FT  |   | AT 4000 FT  |  | AT 6000 FT  |                      |  |
|   | (MPH)                 | (MPH)   | GROUND ROLL          | TO CLEAR 50 FT OBST. | GROUND ROLL | TO CLEAR 50 FT OBST.                                      | GROUND ROLL | TO CLEAR 50 FT OBST.                                   | GROUND ROLL | TO CLEAR 50 FT OBST. |  |
| 6000  | 75                    | 80  | 900                  | 1600                 | 900         | 1700  | 1000        | 1800   | 1000        | 1900                 |  |
| 5800  | 75                    | 80  | 900                  | 1600                 | 900         | 1700  | 1000        | 1800   | 1000        | 1900                 |  |
| 5500  | 70                    | 80  | 800                  | 1500                 | 800         | 1600  | 900         | 1700   | 900         | 1800                 |  |
| 5000  | 65                    | 75  | 700                  | 1400                 | 800         | 1500  | 800         | 1600   | 900         | 1700                 |  |
| 4500  | 65                    | 70  | 600                  | 1300                 | 700         | 1400  | 700         | 1500   | 800         | 1600                 |  |
| REMARKS: 1. Landing distances are airplane requirements under normal service conditions.<br>2. Flaps down 45 degrees.<br>3. Approach power (at sea level): 2000 rpm, 22 in. Hg manifold pressure. |                       |   |                      |                      |             |   |             | LEGEND<br>CAS - CALIBRATED AIRSPEED<br>OBST - OBSTACLE |             |                      |  |
| DATA AS OF 4-17-52<br>BASED ON FLIGHT TEST  |                       | 168-93-1254A  |                      |                      |             | FUEL GRADE: MIL-F-5572, 91/96<br>FUEL DENSITY: 6.0 LB/GAL |             |  |             |                      |  |

**Figure A-6. Landing Distances**

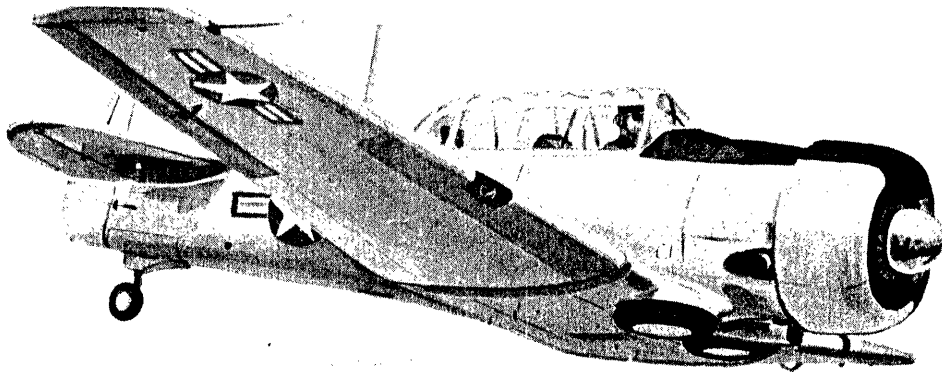

| WADC<br>Form 241U<br>(11 Jun 51)  | <h2 style="margin: 0;">MAXIMUM ENDURANCE CHART</h2> <h3 style="margin: 0;">STANDARD DAY</h3> |      |               |              |                                |              |               |     |         |     |
|---|--|------|---------------|--------------|--------------------------------|--------------|---------------|-----|---------|-----|
| MODEL: T-6G   |  |      |               |              | ENGINE(S): (1) R-1340-AN-1     |              |               |     |         |     |
| CONFIGURATION: CLEAN  |  |      |               |              | CONFIGURATION:                 |              |               |     |         |     |
| GROSS WEIGHT: 5800 POUNDS OR LESS   |  |      |               |              | GROSS WEIGHT:                  |              |               |     |         |     |
| APPROXIMATE   |  |      |               | CAS<br>(MPH) | PRESSURE<br>ALTITUDE<br>(FEET) | CAS<br>(MPH) | APPROXIMATE   |     |         |     |
| GPH   | MIXTURE  | RPM  | MP<br>(IN Hg) |              |                                |              | MP<br>(IN Hg) | RPM | MIXTURE | GPH |
| 17  | M.L.   | 1600 | 21            | 95           | SEA LEVEL                      |              |               |     |         |     |
| 17  | M.L.   | 1600 | 20            | 95           | 5,000                          |              |               |     |         |     |
| 18  | M.L.   | 1600 | 19            | 95           | 10,000                         |              |               |     |         |     |
| 19  | M.L.   | 1600 | 19            | 95           | 15,000                         |              |               |     |         |     |
| 20  | M.L.   | 1900 | F.T.          | 95           | 20,000                         |              |               |     |         |     |
|   |  |      |               |              | 25,000                         |              |               |     |         |     |
|   |  |      |               |              | 30,000                         |              |               |     |         |     |
|   |  |      |               |              | 35,000                         |              |               |     |         |     |
|   |  |      |               |              | 40,000                         |              |               |     |         |     |
|   |  |      |               |              | 45,000                         |              |               |     |         |     |
| CONFIGURATION:  |  |      |               |              | CONFIGURATION:                 |              |               |     |         |     |
| GROSS WEIGHT:   |  |      |               |              | GROSS WEIGHT:                  |              |               |     |         |     |
| APPROXIMATE   |  |      |               | CAS<br>(MPH) | PRESSURE<br>ALTITUDE<br>(FEET) | CAS<br>(MPH) | APPROXIMATE   |     |         |     |
| GPH   | MIXTURE  | RPM  | MP<br>(IN Hg) |              |                                |              | MP<br>(IN Hg) | RPM | MIXTURE | GPH |
|   |  |      |               |              | SEA LEVEL                      |              |               |     |         |     |
|   |  |      |               |              | 5,000                          |              |               |     |         |     |
|   |  |      |               |              | 10,000                         |              |               |     |         |     |
|   |  |      |               |              | 15,000                         |              |               |     |         |     |
|   |  |      |               |              | 20,000                         |              |               |     |         |     |
|   |  |      |               |              | 25,000                         |              |               |     |         |     |
|   |  |      |               |              | 30,000                         |              |               |     |         |     |
|   |  |      |               |              | 35,000                         |              |               |     |         |     |
|   |  |      |               |              | 40,000                         |              |               |     |         |     |
|   |  |      |               |              | 45,000                         |              |               |     |         |     |
| REMARKS: <div style="float: right; text-align: right; margin-top: 10px;"> <b>LEGEND</b><br/>                     GPH - FUEL CONSUMPTION<br/>                     CAS - CALIBRATED AIRSPEED<br/>                     F. T. - FULL THROTTLE<br/>                     M. L. - MANUAL LEAN                 </div> |  |      |               |              |                                |              |               |     |         |     |
| DATA AS OF 9-11-51  |  |      |               |              | FUEL GRADE: MIL-F-5572, 91/96  |              |               |     |         |     |
| BASED ON FLIGHT TEST  |  |      |               |              | FUEL DENSITY: 6.0 LB/GAL       |              |               |     |         |     |
| 168-93-1255A  |  |      |               |              |                                |              |               |     |         |     |

Figure A-7. Maximum Endurance

**COMBAT ALLOWANCE CHART**  
**MILITARY POWER**  
**STANDARD DAY**

MODEL: T-6G

ENGINE(S): (1) R-1340-AN-1

| PRESSURE ALTITUDE (FEET) | RPM  | MP (IN. Hg) | BLOWER POSITION | MIXTURE POSITION | TIME LIMIT (MIN) | LIMIT CYLINDER TEMP(°C) | FUEL FLOW GPM/ENG |
|--------------------------|------|-------------|-----------------|------------------|------------------|-------------------------|-------------------|
| SEA LEVEL                | 2250 | 36.0        |                 | RICH             | 5                | 260                     | 1.20              |
| 2,000                    | 2250 | 36.0        |                 | RICH             | 5                | 260                     | 1.30              |
| 4,000                    | 2250 | F. T.       |                 | RICH             | 5                | 260                     | 1.20              |
| 6,000                    | 2250 | F. T.       |                 | RICH             | 5                | 260                     | 1.04              |
| 8,000                    | 2250 | F. T.       |                 | RICH             | 5                | 260                     | .91               |
| 10,000                   | 2250 | F. T.       |                 | RICH             | 5                | 260                     | .81               |
| 12,000                   | 2250 | F. T.       |                 | RICH             | 5                | 260                     | .72               |
| 14,000                   | 2250 | F. T.       |                 | RICH             | 5                | 260                     | .65               |
| 16,000                   | 2250 | F. T.       |                 | RICH             | 5                | 260                     | .59               |
| 18,000                   | 2250 | F. T.       |                 | RICH             | 5                | 260                     | .54               |
| 20,000                   | 2250 | F. T.       |                 | RICH             | 5                | 260                     | .50               |
| 22,000                   |      |             |                 |                  |                  |                         |                   |
| 24,000                   |      |             |                 |                  |                  |                         |                   |
| 26,000                   |      |             |                 |                  |                  |                         |                   |
| 28,000                   |      |             |                 |                  |                  |                         |                   |
| 30,000                   |      |             |                 |                  |                  |                         |                   |
| 32,000                   |      |             |                 |                  |                  |                         |                   |
| 34,000                   |      |             |                 |                  |                  |                         |                   |
| 36,000                   |      |             |                 |                  |                  |                         |                   |
| 38,000                   |      |             |                 |                  |                  |                         |                   |
| 40,000                   |      |             |                 |                  |                  |                         |                   |

REMARKS:

LEGEND

F. T. - FULL THROTTLE

DATA AS OF 8-29-51  
 BASED ON FLIGHT TEST

FUEL GRADE: MIL-F-5572, 91/96  
 FUEL DENSITY: 6.0 LB/GAL

168-93-1256A

Figure A-8. Combat Allowance



| AIRCRAFT MODEL (S)   |              | FLIGHT OPERATION INSTRUCTION CHART       |           |  |                  |                    |           | EXTERNAL LOAD ITEMS              |   |
|--|--------------|--|-----------|--|------------------|--------------------|-----------|----------------------------------|---|
| T-6G   |              | STANDARD DAY                             |           |  |                  |                    |           | NONE                             |   |
| ENGINE(S): (1) R-1340-AN-1   |              | CHART WEIGHT LIMITS: 5800 POUNDS OR LESS |           |  |                  |                    |           | NUMBER OF ENGINES OPERATING: ONE |   |
| WADC Form 241K (11 Jun 51)   | POWER LIMITS | RPM                                      | MP IN. HG | BLOWER POSITION  | MIXTURE POSITION | TIME LIMIT         | CYL. TEMP | TOTAL GPH                        | INSTRUCTIONS FOR USING CHART: Select figure in FUEL column equal to or less than amount of fuel to be used for cruising. Move horizontally to right or left and select RANGE value equal to or greater than the statute or nautical air miles to be flown. Vertically below and opposite value nearest desired cruising altitude (ALT), read rpm, manifold pressure (MP), and MIXTURE setting required. Refer to corresponding column and altitude for new power settings when gross weight falls below limits of this chart. |
|  |              |  |           |  |                  |                    |           |                                  |   |
|  |              | 2250                                     | 36.0      | RICH   |                  |                    |           |                                  |   |
| <p>NOTES: Column I is for emergency high-speed cruising only. Columns II, III, IV, and V give progressive increase in range at a sacrifice in speed. Air miles per gallon (MI/GAL) (no wind), gallons per hr (GPH), and true airspeed (TAS) are approximate values for reference. Range values are for an average airplane flying alone (no wind) (1).</p> |              |  |           |  |                  |                    |           |                                  |   |
| COLUMN I   |              | COLUMN II                                |           | COLUMN III   |                  | COLUMN IV          |           | COLUMN V                         |   |
| RANGE IN AIR MILES   |              | RANGE IN AIR MILES                       |           | RANGE IN AIR MILES                                     |                  | RANGE IN AIR MILES |           | RANGE IN AIR MILES               |   |
| STATUTE  | NAUTICAL     | STATUTE                                  | NAUTICAL  | STATUTE  | NAUTICAL         | STATUTE            | NAUTICAL  | STATUTE                          | NAUTICAL  |
|  |              |  |           | SUBTRACT FUEL ALLOWANCES NOT AVAILABLE FOR CRUISING(1) |                  |                    |           |                                  |   |
| 400  |              | 540                                      |           | 690  |                  | 790                |           | 840                              |   |
| 340  |              | 450                                      |           | 570  |                  | 650                |           | 700                              |   |
|  |              | 360                                      |           | 460  |                  | 520                |           | 560                              |   |
| 270  |              | 270                                      |           | 340  |                  | 390                |           | 420                              |   |
| 200  |              | 230                                      |           | 310  |                  | 330                |           | 360                              |   |
|  |              | 180                                      |           | 230  |                  | 260                |           | 280                              |   |
| 130  |              | 90                                       |           | 110  |                  | 130                |           | 140                              |   |
| 70   |              | 150                                      |           | 200  |                  | 230                |           | 240                              |   |
|  |              | 80                                       |           | 100  |                  | 110                |           | 120                              |   |
| MAXIMUM CONTINUOUS   |              | MAXIMUM CONTINUOUS                       |           | MAXIMUM CONTINUOUS                                     |                  | MAXIMUM CONTINUOUS |           | MAXIMUM AIR RANGE                |   |
| RPM  | MP INCHES    | MIX. TURE                                | TOTAL GPH | TAS  | ALT FEET         | APPROX             | APPROX    | APPROX                           | APPROX  |
|  |              |  |           |  |                  |                    |           |                                  |   |
| 2200   | 27           | RICH                                     | 27        | 180  | 155              | 20,000             | 20,000    | 2000                             | F.T. M.L. 21  |
| 2200   | 35           | RICH                                     | 35        | 195  | 170              | 15,000             | 15,000    | 2000                             | F.T. M.L. 26  |
| 2200   | 45           | RICH                                     | 45        | 205  | 175              | 10,000             | 10,000    | 1700                             | F.T. M.L. 24  |
| 2200   | 60           | RICH                                     | 60        | 215  | 185              | 5,000              | 5,000     | 1600                             | F.T. M.L. 23  |
| 2200   | 54           | RICH                                     | 54        | 200  | 170              | SL                 | SL        | 1600                             | F.T. M.L. 20  |

**SPECIAL NOTES**

(1) Make allowance for warm-up, take-off, and climb plus allowance for wind, reserve, and combat as required.

**EXAMPLE**

At 5700 lb gross weight with 100 gal of fuel (after deducting total allowances of 38 gal) to fly 450 stat. air miles at 15,000 ft altitude, maintain 2200 rpm and F.T. with mixture set: RICH.

**LEGEND**

ALT : PRESSURE ALTITUDE  
 MP : MANIFOLD PRESSURE  
 GPH : GALLONS PER HOUR  
 TAS : TRUE AIRSPEED  
 KN : KNOTS  
 F.T. : FULL THROTTLE  
 M.L. : MANUAL LEAN  
 FUEL GRADE: MIL-F-5572, 91/96 FUEL DENSITY: 6.0 LB/GAL

Figure A-9. Flight Operation Instruction Chart



# Index

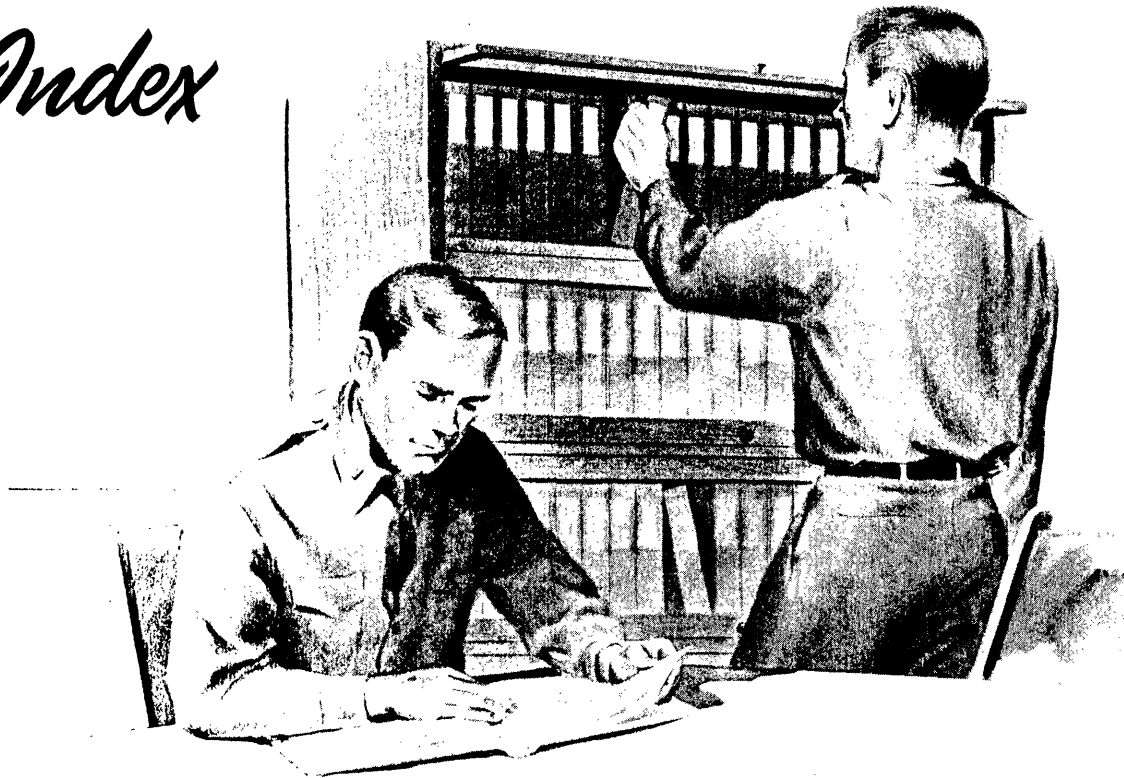

|  |  |
|--|--|
| <b>A</b>                                       | <b>C</b>                                       |
| After Landing ..... 37                         | Canopy ..... 26                                |
| cold-weather procedure ..... 82                | panels, removable ..... 26, 44                 |
| After Take-off ..... 34                        | Carburetor ..... 1                             |
| cold-weather procedure ..... 81                | control, air ..... 3                           |
| engine failure ..... 40                        | icing ..... 72, 77                             |
| Ailerons ..... 11                              | manual leaning ..... 72                        |
| Air Conditioning System                        | Center-of-gravity Limitations ..... 63         |
| <i>see:</i> Heating System                     | Charts ..... 83                                |
| Ventilating System                             | airspeed installation correction ..... 83, 84  |
| Air Induction System ..... 4                   | altimeter installation correction ..... 83, 85 |
| control, carburetor air ..... 3                | combat allowance ..... 84, 92                  |
| Airspeed Installation Correction ..... 83, 84  | flight operation instruction ..... 84, 93      |
| Airspeed Limitations ..... 60, 62              | fuel quantity data ..... 8                     |
| Air Temperature Correction ..... 83            | instrument markings ..... 60, 61               |
| Altimeter Installation Correction ..... 83, 85 | landing distances ..... 84, 90                 |
| Ammeter ..... 8                                | maximum endurance ..... 84, 91                 |
| Approach ..... 35                              | Normal Power climb ..... 84, 89                |
| cold-weather procedure ..... 81                | operating flight strength ..... 63             |
| instrument approaches ..... 77                 | stall speeds ..... 67                          |
| Armrest ..... 58                               | take-off distances ..... 83, 88                |
|  | use of ..... 35                                |
| <b>B</b>                                       | Check Lists                                    |
| Bail-out ..... 44, 45                          | Pilot's Training and Transition ..... 58       |
| Battery ..... 8                                | traffic pattern ..... 36                       |
| switch, battery-disconnect ..... 8             | Checks   |
| Before Entering Airplane ..... 27              | exterior ..... 27, 28                          |
| cold-weather procedure ..... 79                | ground tests ..... 30, 31                      |
| Before Leaving Airplane ..... 38               | interior ..... 27, 29                          |
| cold-weather procedure ..... 82                | postflight ..... 37                            |
| Before Take-off ..... 31                       | preflight ..... 31                             |
| airplane check, preflight ..... 31             | Circuit Breakers ..... 8                       |
| cold-weather procedure ..... 81                | Climb ..... 34                                 |
| engine check, preflight ..... 32               | cold-weather procedure ..... 81                |
| instrument operation ..... 75                  | instrument operation ..... 76                  |
| thunderstorm flight ..... 78                   | Normal Power climb ..... 84, 89                |
| Brake System ..... 13, 13                      | Cockpits ..... 14-18, 20-25                    |
| handle, parking brake ..... 13                 | emergency entrance ..... 43                    |
|  | smoke elimination ..... 79                     |

PAGE NUMBERS IN *ITALICS* DENOTE ILLUSTRATIONS

## Cold-weather — Glide, Maximum

|  |            |
|--|------------|
| Cold-weather Procedures .....              | 79         |
| Combat Allowance .....                     | 84, 92     |
| Communications and Associated              |            |
| Electronic Equipment .....                 | 47, 48, 49 |
| command radio, AN/ARC-3 vhf .....          | 48, 49     |
| button, microphone control .....           | 50         |
| light, vhf control indicator .....         | 50         |
| operation .....                            | 50         |
| panel, control .....                       | 50         |
| switch, control transfer .....             | 50         |
| command radio, SCR-522A vhf .....          | 48, 49     |
| interphone .....                           | 48, 49     |
| knob, volume control .....                 | 54         |
| operation .....                            | 54         |
| switch .....                               | 54         |
| operation .....                            | 51, 52     |
| panel, control .....                       | 51, 51     |
| push button, control transfer .....        | 51         |
| switch, control transfer .....             | 51         |
| instrument landing system .....            | 48, 49     |
| course reminder .....                      | 55         |
| operation .....                            | 55         |
| panel, control .....                       | 54         |
| push button, control transfer .....        | 54         |
| switch, transfer .....                     | 54         |
| interphone, USAF combat type .....         | 48, 49     |
| knob, volume control .....                 | 54         |
| operation .....                            | 54         |
| switch .....                               | 54         |
| keyer, emergency .....                     | 48, 49     |
| marker beacon, AN/ARN-12 .....             | 48, 49     |
| operation .....                            | 53         |
| marker beacon, RC-193A .....               | 48, 49     |
| operation .....                            | 53         |
| panel, interphone control .....            | 47         |
| push button, d/f tone .....                | 52         |
| radio compass, AN/ARN-6 .....              | 48, 49     |
| operation .....                            | 53         |
| panel, control .....                       | 53         |
| radio compass, AN/ARN-7 .....              | 48, 49     |
| operation .....                            | 52         |
| panel, control .....                       | 52         |
| switch, radio range filter .....           | 52         |
| Control Lock Handle .....                  | 11         |
| Controls .....                             |            |
| <i>see applicable system</i>               |            |
| Control Stick .....                        | 11         |
| Crew Requirements, Minimum .....           | 59         |
| Cross-wind Landing .....                   | 35         |
| Cross-wind Take-off .....                  | 33         |
| Cruising Flight, Instrument .....          | 76         |
| <b>D</b>                                   |            |
| Data Case .....                            | 58         |
| Descent .....                              | 34         |
| cold-weather procedure .....               | 81         |
| instrument operation .....                 | 77         |
| Detonation .....                           | 72         |
| Dimensions .....                           | 1          |
| Ditching .....                             | 44         |
| Dives .....                                | 69, 70     |
| Downlock, Landing Gear .....               | 12         |
| emergency downlock .....                   | 45         |
| lights, indicator .....                    | 12, 55     |
| <b>E</b>                                   |            |
| Electrical Power Supply System .....       | 8, 9       |
| ammeter .....                              | 8          |
| battery .....                              | 8          |
| switch, battery-disconnect .....           | 8          |
| circuit breakers .....                     | 8          |
| emergency operation .....                  | 45         |
| fire .....                                 | 41         |
| generator .....                            | 8          |
| switch, main-line .....                    | 8          |
| receptacle, external power .....           | 8          |
| Electronic Equipment .....                 |            |
| <i>see Communications and Associated</i>   |            |
| Electronic Equipment .....                 |            |
| Elevators .....                            | 11         |
| Emergency Equipment .....                  | 19         |
| Emergency Procedures .....                 |            |
| <i>see applicable system</i>               |            |
| emergency entrance .....                   | 43         |
| emergency escape on the ground .....       | 44, 44     |
| Engine .....                               | 1          |
| carburetor icing .....                     | 72         |
| controls .....                             | 1          |
| carburetor air .....                       | 3, 4       |
| crank .....                                | 4          |
| mixture .....                              | 3, 4       |
| primer .....                               | 4          |
| switch, ignition .....                     | 4          |
| switch, starter .....                      | 4          |
| throttle .....                             | 3, 4       |
| detonation .....                           | 72         |
| failure .....                              | 39         |
| fire .....                                 | 40         |
| hand-cranking .....                        | 46         |
| indicators .....                           | 4          |
| manual leaning .....                       | 72         |
| operation .....                            | 29         |
| cold-weather procedure .....               | 79         |
| ground tests .....                         | 30, 31     |
| limitations .....                          | 59, 60-62  |
| postflight check .....                     | 37         |
| preflight check .....                      | 32         |
| starting .....                             | 29         |
| stopping .....                             | 38, 82     |
| Take-off Power, use of .....               | 71         |
| power settings, changing .....             | 72         |
| preignition .....                          | 72         |
| throttle "jockeying" .....                 | 72         |
| valve, manifold pressure gage drain .....  | 5          |
| Entrance, Emergency .....                  | 43         |
| Exterior Inspection .....                  | 27, 28     |
| External Power Receptacle .....            | 8          |
| <b>F</b>                                   |            |
| Fire .....                                 | 40         |
| electrical .....                           | 41         |
| engine .....                               | 40         |
| fuselage .....                             | 41         |
| wing .....                                 | 41         |
| Fire Extinguisher .....                    | 19, 43     |
| First-aid Kit .....                        | 19         |
| Flaps, Wing .....                          | 11         |
| handle .....                               | 11         |
| indicator, position .....                  | 11         |
| Flat Tire .....                            | 43         |
| Flight Characteristics .....               | 65         |
| Flight Control System .....                | 11         |
| control stick .....                        | 11         |
| flight characteristics .....               | 65         |
| lock .....                                 | 11         |
| rudder pedal adjustment .....              | 11         |
| trim tab wheels, rudder and elevator ..... | 11         |
| Flight, Maneuvering .....                  | 65         |
| Flight Operation Instruction Chart .....   | 84, 93     |
| Flight Report Case .....                   | 58         |
| Fuel System .....                          | 6, 7       |
| controls .....                             | 6          |
| emergency operation .....                  | 45         |
| flight operation .....                     | 73         |
| fuel quantity data .....                   | 8          |
| fuel specification .....                   | 26         |
| indicators .....                           | 6          |
| gage, fuel pressure .....                  | 6          |
| gages, fuel quantity .....                 | 6, 6       |
| switch, light .....                        | 57         |
| lights, low fuel quantity warning .....    | 8          |
| Fuselage Fire During Flight .....          | 41         |
| <b>G</b>                                   |            |
| Gages .....                                |            |
| <i>see applicable system</i>               |            |
| Generator .....                            | 8          |
| switch, main-line .....                    | 8          |
| Glide, Maximum .....                       | 40, 41     |

PAGE NUMBERS IN ITALICS DENOTE ILLUSTRATIONS

|   |                |   |                |
|---|----------------|---|----------------|
| Glide Path Receiver .....                 | 48, 49         | exterior .....                                      | 55, 55         |
| <i>also see</i> Instrument Landing System |                | switch, cowl light .....                            | 56             |
| G-load Limitations .....                  | 62             | switches, landing light .....                       | 56             |
| Go-around .....                           | 37, 37         | switch, navigation and cowl light brilliancy .....  | 56             |
| Ground Controlled Approach .....          | 77             | switch, navigation light .....                      | 56, 56         |
| Ground Tests .....                        | 30, 31         | switch, passing light .....                         | 56             |
| cold-weather procedure .....              | 80             | interior .....                                      | 56             |
| <b>H</b>                                  |                |   |                |
| Handles                                   |                | knobs, fluorescent light control .....              | 56             |
| <i>see</i> applicable system              |                | rheostat and switch, fuel quantity gage light ..... | 57             |
| Heater, Pitot .....                       | 47             | rheostat, cockpit light .....                       | 57             |
| Heating System .....                      | 47             | rheostat, console light .....                       | 57             |
| Holding .....                             | 77             | rheostat, radio compass control panel light .....   | 52, 57         |
| Hood, Instrument Flying .....             | 57, 57         | switches, radio compass control panel light .....   | 53, 57         |
| release button .....                      | 58             | Limitations, Operating .....                        | 59, 60-62      |
| Hydraulic Power Supply System .....       | 10, 11         | Localizer Receiver .....                            | 48             |
| gage, pressure .....                      | 11             | <i>also see</i> Instrument Landing System           |                |
| hand-pump .....                           | 11             | Locks   |                |
| hydraulic fluid specification .....       | 26             | flight controls .....                               | 11             |
| <b>I</b>                                  |                |   |                |
| Icing, Carburetor .....                   | 72, 77         | friction lock, throttle quadrant .....              | 1              |
| Icing, Wing .....                         | 77             | shoulder harness, inertia reel .....                | 26             |
| Ignition Switch .....                     | 4              | <b>M</b>  |                |
| Indicators                                |                | Main Differences Table .....                        | 3              |
| <i>see</i> applicable system              |                | Maneuvering Flight .....                            | 65             |
| Instrument Flight Procedures .....        | 75             | Maneuvers, Prohibited .....                         | 62             |
| Instrument Landing System .....           | 48, 49         | Manual Leaning, Engine .....                        | 72             |
| course reminder .....                     | 55             | Map and Data Case .....                             | 58             |
| operation .....                           | 55             | Marker Beacon, AN/ARN-12 .....                      | 48, 49         |
| panel, control .....                      | 54             | operation .....                                     | 53             |
| push button, control transfer .....       | 54             | Marker Beacon, RC-193A .....                        | 48, 49         |
| switch, transfer .....                    | 54             | operation .....                                     | 53             |
| Instrument Markings .....                 | 60, 61         | Maximum Endurance .....                             | 84, 91         |
| Instruments .....                         | 13             | Minimum-run Take-off .....                          | 33, 34         |
| <i>also see</i> applicable system         |                | Mirror, Rearview .....                              | 58             |
| markings .....                            | 60, 61         | Mixture Control .....                               | 3, 4           |
| panels .....                              | 14, 15, 20, 21 | manual leaning .....                                | 72             |
| knobs, fluorescent light control .....    | 56             | <b>N</b>  |                |
| switch, gyro .....                        | 19             | Night Flying .....                                  | 75             |
| Interior Checks .....                     | 27             | interior check .....                                | 29             |
| Interphone, USAF Combat Type .....        | 48, 49         | landing .....                                       | 37             |
| knob, volume control .....                | 54             | take-off .....                                      | 33             |
| operation .....                           | 54             | Normal Power Climb .....                            | 84, 89         |
| switch .....                              | 54             | <b>O</b>  |                |
| Interphone, USAF Combat Type .....        | 48, 49         | Oil System .....                                    | 5              |
| knob, volume control .....                | 54             | oil dilution system .....                           | 5              |
| operation .....                           | 54             | cold-weather procedure .....                        | 82             |
| switch .....                              | 54             | switch .....  | 5              |
| <b>K</b>                                  |                |   |                |
| Keyer, Emergency .....                    | 48             | oil specification .....                             | 26             |
| Kit, First-aid .....                      | 19             | On Entering Airplane .....                          | 27             |
| Knobs, Control                            |                | <b>P</b>  |                |
| <i>see</i> applicable system              |                | Panels, Instrument .....                            | 14, 15, 20, 21 |
| <b>L</b>                                  |                |   |                |
| Landing .....                             | 35, 36         | knobs, fluorescent light control .....              | 56             |
| after landing .....                       | 37             | Parking Brake Handle .....                          | 13             |
| cold-weather procedure .....              | 82             | Pitot Heater .....                                  | 47             |
| cross-wind landing .....                  | 35             | Postflight Engine Check .....                       | 37             |
| dead-engine .....                         | 40, 42         | Preflight Checks .....                              | 31             |
| distances .....                           | 84, 90         | exterior inspection .....                           | 27             |
| emergencies .....                         | 43             | ground tests .....                                  | 30, 31         |
| final approach and touchdown .....        | 35, 35         | interior inspection .....                           | 27, 29         |
| light switches .....                      | 56             | weight and balance .....                            | 27             |
| night landing .....                       | 37             | Preflight Planning .....                            | 27             |
| roll .....                                | 35             | Preignition .....                                   | 72             |
| Landing Gear System .....                 | 11, 12         | Primer .....  | 4              |
| controls .....                            | 12             | Prohibited Maneuvers .....                          | 62             |
| handle .....                              | 12, 13         | Propeller .....                                     | 5              |
| handle, emergency downlock .....          | 12, 13, 45     | control .....                                       | 5              |
| emergency operation .....                 | 43, 45, 46     | failure .....                                       | 40             |
| horn, warning .....                       | 12             | limitations .....                                   | 59             |
| indicator, position .....                 | 12             | operation .....                                     | 73, 73         |
| lights, downlock indicator .....          | 12, 55         | Pump, Hydraulic .....                               | 11             |
| Levers                                    |                | <b>R</b>  |                |
| <i>see</i> applicable system              |                | Radio, AN/ARC-3 VHF Command .....                   | 48, 49         |
| Lighting Equipment .....                  | 55, 55         | button, microphone control .....                    | 50             |
|   |                | light, vhf control indicator .....                  | 50             |
|   |                | operation .....                                     | 50             |

## Radio Compass — Wing Icing

|                                     |            |
|-------------------------------------|------------|
| panel, control .....                | 50         |
| switch, vhf control transfer .....  | 50         |
| Radio Compass, AN/ARN-6 .....       | 48, 49     |
| operation .....                     | 53         |
| panel, control .....                | 53         |
| Radio Compass, AN/ARN-7 .....       | 48, 49     |
| operation .....                     | 52         |
| panel, control .....                | 52         |
| Radio, SCR-522A VHF Command .....   | 48, 49     |
| interphone .....                    | 48, 49     |
| knob, volume control .....          | 54         |
| operation .....                     | 54         |
| switch .....                        | 54         |
| operation .....                     | 51, 52     |
| panel, control .....                | 51, 51     |
| push button, control transfer ..... | 51         |
| switch, control transfer .....      | 51         |
| Receiver, Glide Path .....          | 48, 49, 54 |
| Receiver, Localizer .....           | 48, 49, 54 |
| Receptacle, External Power .....    | 8          |
| Relief Tube .....                   | 58         |
| Rheostats .....                     |            |
| <i>see applicable system</i> .....  |            |
| Rudder .....                        | 11         |

**S**

|  |        |
|--|--------|
| Seats .....                                      | 26     |
| handle, shoulder harness inertia reel lock ..... | 26     |
| lever, adjustment .....                          | 26     |
| Servicing Diagram .....                          | 26     |
| Shoulder Harness Inertia Reel Lock Handle .....  | 26     |
| Smoke Elimination .....                          | 43     |
| Spins .....                                      | 65, 66 |
| Stalls .....                                     | 66, 67 |
| Starter Switch Pedal .....                       | 4      |
| Starting Engine .....                            | 29     |
| cold-weather procedure .....                     | 80     |
| fire during starting .....                       | 41     |
| fire during starting .....                       | 40     |
| Steering System .....                            | 12     |
| Stopping Engine .....                            | 38     |
| cold-weather procedure .....                     | 82     |
| Strength, Operating Flight .....                 | 62, 63 |
| Switches .....                                   |        |
| <i>see applicable system</i> .....               |        |

**T**

|                                       |        |
|---------------------------------------|--------|
| Tail Wheel Steering System .....      | 12     |
| Take-off .....                        | 33     |
| <i>also see: After Take-off</i> ..... |        |
| Before Take-off .....                 |        |
| cold-weather procedure .....          | 81     |
| cross-wind .....                      | 33     |
| distances .....                       | 83, 88 |
| engine failure after take-off .....   | 40     |
| engine failure during take-off .....  | 40     |
| instrument operation .....            | 76     |
| minimum-run .....                     | 33, 34 |
| night .....                           | 33     |
| normal .....                          | 33     |
| Take-off Power, Use of .....          | 71     |
| Taxiing Instructions .....            | 30     |
| cold-weather procedure .....          | 80     |
| cross-wind .....                      | 31     |
| downwind .....                        | 31     |
| upwind .....                          | 31     |
| Throttle .....                        | 3, 4   |
| "jockeying" .....                     | 72     |
| quadrant .....                        | 4      |
| Thunderstorms, Flight During .....    | 78     |
| Traffic Pattern Check List .....      | 36     |
| Trim Tabs .....                       | 11     |

**V**

|                                    |    |
|------------------------------------|----|
| Valves .....                       |    |
| <i>see applicable system</i> ..... |    |
| Ventilating System .....           | 47 |

**W**

|                                  |    |
|----------------------------------|----|
| Warm-up Procedure .....          | 30 |
| cold-weather procedure .....     | 80 |
| Warning Horn, Landing Gear ..... | 12 |
| Weight and Balance .....         | 27 |
| Weight Limitations .....         | 63 |
| Wing Fire During Flight .....    | 41 |
| Wing Flaps .....                 | 11 |
| handle .....                     | 11 |
| indicator, position .....        | 11 |
| Wing Icing .....                 | 77 |



Everything about...



# NORTH AMERICAN AVIATION





S I C U R O

E N G I N E E R I N G